

Hydraulic unit

WSEP100KR3



INSTALLATION

EN

Fujitsu Airstage Monobloc Comfort WH

Monobloc 1 service air/water heat pump
Indoor Unit



■ Installation and maintenance rules

The appliance must be installed and maintained by an approved professional in accordance with current regulations and codes of practice.

■ Location

The heat pump installation must conform to the legislation and regulations of the installation site of the heat pump.

- **Warning, hydraulic module should not be installed in an air current.**

■ Hydronic connections

The connection must conform to industry standard practice according to current regulations.

Reminder: Seal everything when fitting in accordance with industry standard practice for plumbing work:

- Use suitable seals (fibre gasket, O-ring).
- Use Teflon or hemp tape.
- Use sealing paste (synthetic depending on the case).

Use glycol/water mix if the minimum flow temperature is set below 10°C..

Use glycol/water mix if the outdoor hydronic circuit is subject to a frost risk.

For the outdoor hydronic circuit, use an insulation which is suitable for outdoor use and is UV/moisture-resistant (usage temperature -20 to +70 °C).

If you are using a glycol/water mix, arrange for an annual check on the quality of the glycol. Use monopropylene glycol only. The recommended concentration is 40% max. (30% minimum).

Never use monoethylene glycol.

- **In some installations, the presence of different metals can cause corrosion problems; the formation of metal particles and sludge can appear in the hydronic circuit.**

- **In this case, it is advisable to use a corrosion inhibitor in the proportions indicated by the manufacturer.**

- **You must also ensure that treated water does not become corrosive.**

If a domestic hot water tank is installed, on the cold water inlet, place a safety valve calibrated to between 7 and 10 bar max. (depending on local regulations) and connected to a drain pipe leading to the sewer. Operate the safety valve according to manufacturer's specifications. The pressure-limiting device should be operated regularly to remove scale deposits and check that it is not blocked. The domestic hot water tank must be fed with cold water passing through a safety valve. There must be no other valves between the safety valve and the tank.

The discharge pipe must be connected to the sewer. The discharge pipe must be kept open in the open air. The discharge pipe must be installed in an environment kept frost-free and in a continuous downward slope.

Emptying the hot water tank

Remove the front panel from the hydronic unit. Close the cold water inlet into the tank. Connect a pipe on the drain valve of the water tank drain valve for discharging water to the sewer. The discharge pipe must be kept open in the open air. Open a hot water tap and open the water tank drain valve.



■ Electrical connections

Before performing any maintenance, make sure that all power supplies have been isolated.

• Specifications of electricity supply

The electrical installation must be carried out in accordance with current regulations.

For installations without neutral, use a galvanically isolated transformer earthed on the secondary side.

Electrical connections will only be made once all other installation operations (fastening, assembly, etc.) have been completed.

Warning!

The contract signed with the energy provider must be sufficient not only to cover the heat pump's power requirements but also the combined sum of all the appliances likely to be operating at the same time. If the power is too low, check the power rating stated in your contract with your energy provider.

Never use a power socket for the power supply.

The heat pump must be supplied directly with power (without external switch) by special protected leads from the electric panel via dedicated bipolar circuit breakers, C curve for the outdoor unit, C curve for the electrical heating* and domestic water backups* (see tables on page 3).

The electrical installation must be fitted with a 30mA RCD.

This appliance is designed to operate using a rated voltage of 230V +/- 10%, 50 Hz.

• General remarks on electrical connections

It is essential to maintain neutral-phase polarity when making electrical connections.

Rigid wires are preferable for fixed installations, particularly in a building.

Tighten the cables using the cable glands to prevent the power cables from being accidentally disconnected.

The earth connection and its continuity must be ensured.

The earth wire must be longer than the other wires.

• Cable glands

To ensure the stability of power (Low Voltage) and sensor (Extra-Low Voltage) cables, it is essential that the cable glands are tightened according to the following recommendations:

Size of cable gland (mm)	Diameter of cable (mm)	Cable gland tightening torque (check-nut) (N.m)	Coupling nut tightening torque (N.m)
PG7	1 to 5	1.3	1
PG9	1.5 to 6	3.3	2.6
PG16	7 to 14	4.3	2.6
PG21	13 to 18	5	4

• Connecting to controller boards

- Remove the corresponding connector and make the connection.

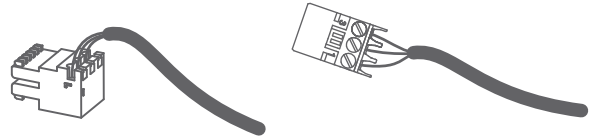

Pre-cabled bundle connector and/or screw connector

• Connecting to spring terminals

- Strip wire end around 12 mm.
- Push the spring with a screwdriver so that the wire enters the cage.
- Slide the wire into the opening provided for this purpose.
- Remove the screwdriver and then check that the wire stays gripped by the cage by pulling on it

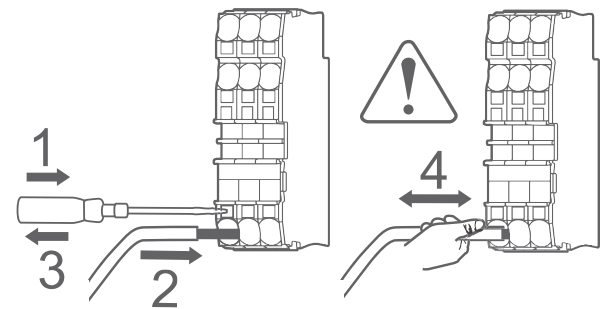
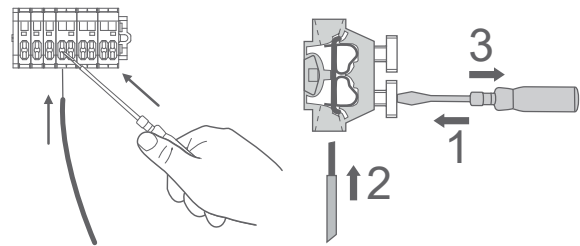

(* depending on options / setting)

 Read the document comprising the precautions for use (regulation installation and maintenance conditions) before installation and/or use.

 This document was written in French and translated.

► Symbols and definitions



WARNING. Risk of serious injury to the person and / or risk of damage to the machine. Observe the warning.



Warning: Electricity hazard.



Important information that must always be kept in mind.



Read the installation manual.



Tips and tricks / Advice.



Read the Operating Manual.



Bad practice.



Read the instructions.

Content

Q Presentation of the equipment	6
Packing list	6
Optional accessories	6
Scope	6
Specification	7
Operating principle	10
🏠 Location	11
Installing the hydraulic unit	11
💧 Hydronic connections	12
Flushing the installation	12
Outdoor unit	12
Heating circuit hydronic connecting	13
Volume of the heating system.	13
Filling and bleeding the installation.	13
🔧 Electrical connections	14
Cable dimensions and protection rating	14
Hydraulic unit	15
Options	17
Outdoor sensor	17
🎛️ Controller Interface	20
User Interface	20
Display Description	21
🌡️ Flow setpoint	22
WITH room thermostat	22
WITHOUT room thermostat	22
⚙️ Commissioning	23
Pre-commissioning checks	23
First commissioning	23
Easy Start	23
Hydraulic unit purging	24
Sludge pot cleaning	24
🏠 Controller menu	25
Menu structure	25
Active Functions	26
Installed Options	27
Domestic Hot Water	28
Heating/Cooling	29
Heat Pump	30
Additional functions.	31
Radio Network	32
Diagnosis	34
🔧 Fault Diagnosis	36
Faults in the Hydraulic unit	36
Outdoor unit error	37
🔧 Installation maintenance	38
Preventive maintenance operations	38
📁 Appendices	40
Basic hydraulic layout.	40
Electrical cabling plan	43
✅ Start-up procedure	44
Start-up check-list.	44
Commissioning data sheet	46
🗨️ Instruction for the end user	47

Q Presentation of the equipment

► Packing list

- **1 package:** Hydraulic unit.

■ Package pairing table

Heat pump Model	Outdoor unit Reference	Code	Hydraulic unit Reference	Code
Fujitsu Airstage Monobloc Comfort WH 5	WPEG050KRF	750918	WSEP100KR3	024317
Fujitsu Airstage Monobloc Comfort WH 8	WPEG080KRF	750919		
Fujitsu Airstage Monobloc Comfort WH 10	WPEG100KRF	750920		

Accessories

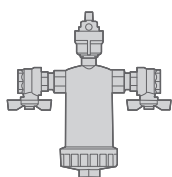

Sediment trap (800µ)

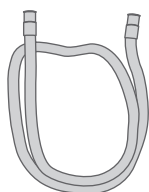

Drain pipe

► Optional accessories

- **Room Thermostat**
Room Thermostat 225 (Code UTW-C225XQ)
Room Thermostat 228 (Code UTW-C228XQ)
- **Outdoor sensor** (Code UTW-KESXQ).
- **2 circuits kit** (Code UTW-KZSXQ)
for connecting 2 heating circuits.
- **Extension regulation kit** (Code UTW-KREXQ)
to control a 2nd heating circuit, off-peak management, load shedding, smart grid, external control...
- **Backup heater 6 kW kit** (Code UTW-KBHXQ) to increase the heat pump's electrical backup from 3 to 6 kW.
- **DHW kit** (Code UTW-KDWXQ) for connecting a mixed DHW tank (with built-in electrical backups).
- **Cooling kit** (Code UTW-KCDXQ).

► Scope

This heat pump provides:

- Heating in winter,
- Management of two heating circuits*,
- Production of domestic hot water*,
- Cooling in summer* (for floor / ceiling heating-cooling system or fan-convectors).

*: Depending on options / requiring installation of additional kits (see § "Optional equipment")

► Specification

Model name		
Electrical characteristics		
Electrical voltage (50 Hz)	V	230
Maximum current	A	-
Circulation pump power consumption	W	75
Hydronic circuit		
Connection size / Pipe diameter Inlet (outdoor unit)	Inches	1"
Connection size / Pipe diameter Flow (heating)	Inches	3/4"
Valve diameter (Sediment trap)	Inches	1"
Maximum operating pressure	MPa (bar)	0.3 (3)
Miscellaneous		
Hydraulic unit weight (empty/full of water)	Kg	34 / 50
Hydraulic unit / DHW tank water capacity	l	16
Expansion tank capacity	l	12
Room temperature	°C	+5 / +30
Radio characteristics		
Frequency bands	MHz	2400 to 2483,5
Zigbee maximum power	dBm	11.94
Wifi maximum power	dBm	16.1
Heating system operating limits		
Initial max. heating water temperature under-floor heating	°C	45
Max. water temperature for radiator heating	°C	60
Initial min. water temperature	°C	8

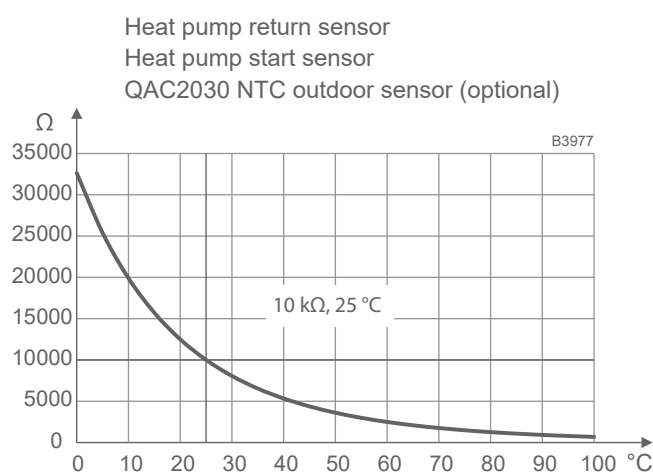

fig. 1 - Ohmic sensor values

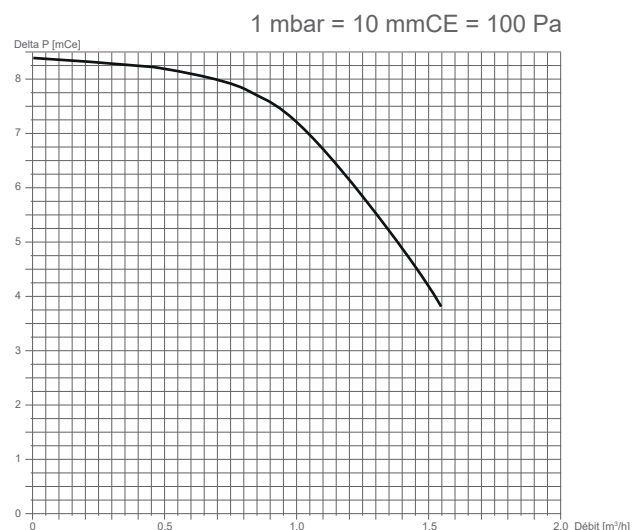

fig. 2 - Available hydronic pressures and flow rates

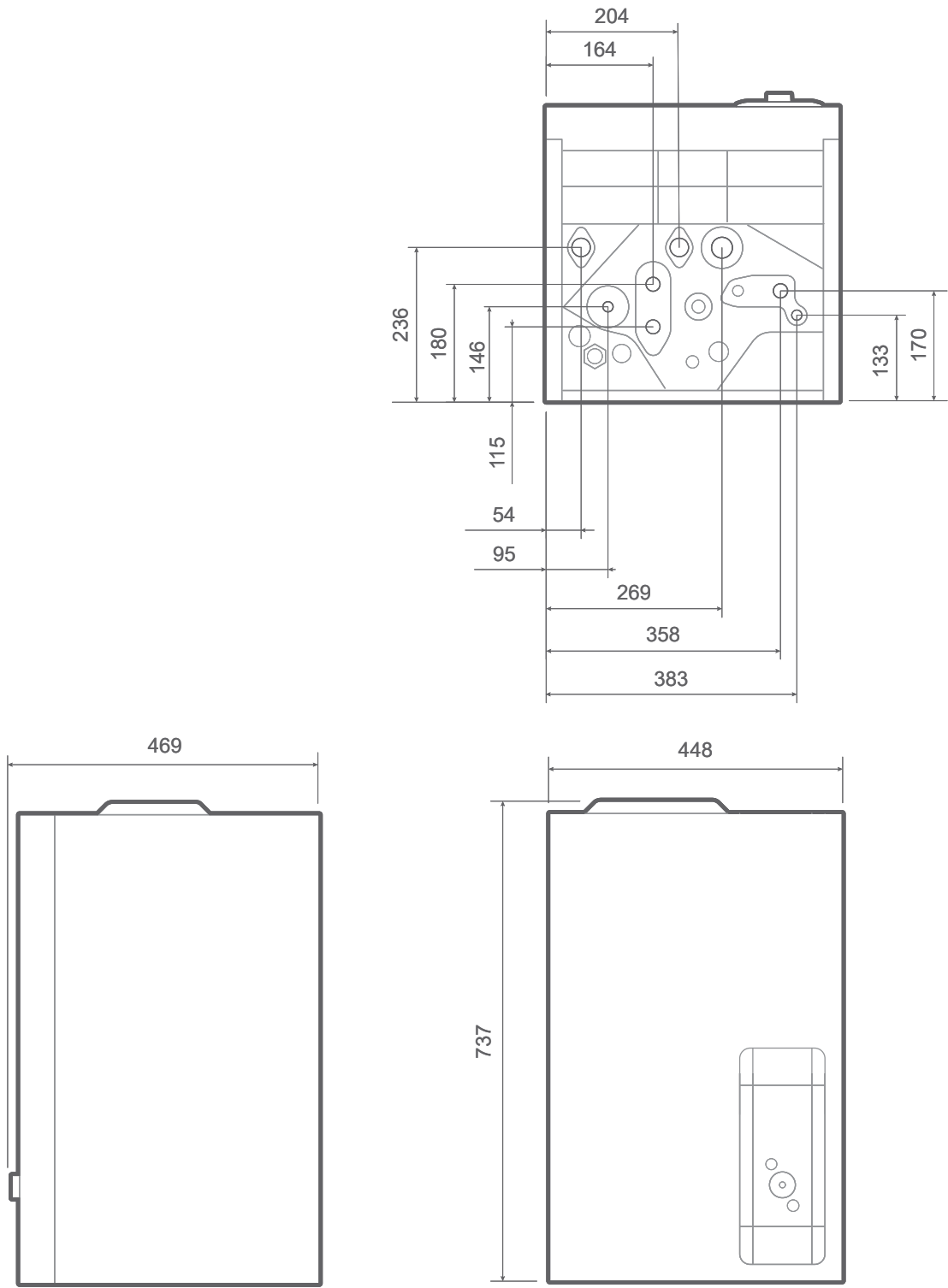
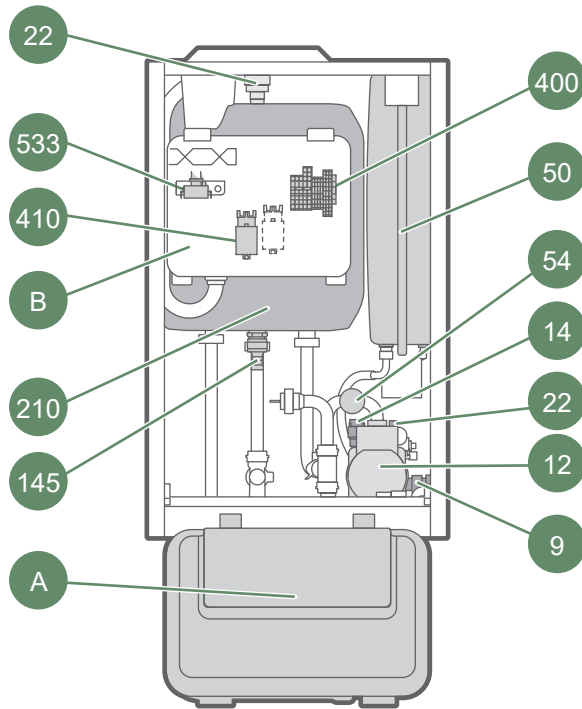

fig. 3 - Dimensions in mm



Electric case:

A - Principal

B - Electric heating backup

9 - Pressure sensor

12 - Circulating pump

14 - Pressure relief valve (PRV)

22 - Automatic bleeder valve

50 - Expansion vessel

54 - Manometer

145 - Drain valve

210 - Buffer tank

400 - Power supply terminal blocks

410 - Relay

533 - Heat pump backup safety thermostat

fig. 4 - Hydraulic unit components

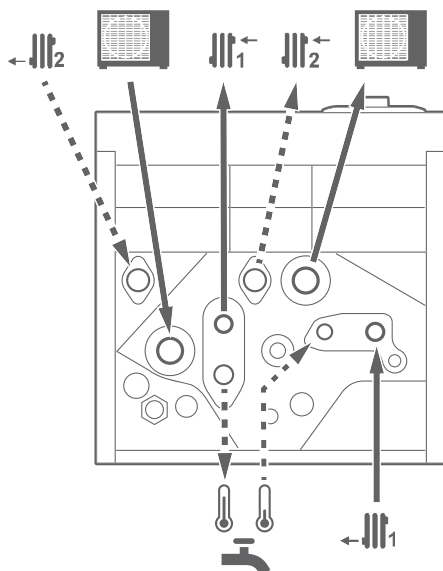

fig. 5 - Hydronic connections

► Operating principle

The hydraulic unit has a regulator that allows:

- heating
- cooling
- domestic hot water*

■ Heating and cooling operating principle

The flow temperature of the heating/cooling circuit is calculated :

- By temperature control via outdoor temperature measurement.
- By room correction (Smart adapt) via thermostat (optional).

Depending on the power required, the heat pump modulates the compressor and regulates the power reserve to maintain the flow temperature.

The summer/winter changeover can be organized automatically by activating the automatic mode.

In this case, the heat pump switches between heating, off and cooling modes depending on the outdoor temperature.

■ Fan-convector with integrated control

Do not use the room sensor in the zone concerned.

■ Domestic hot water (DHW) operating principles*

Two domestic hot water (DHW) temperatures can be set: Comfort and ECO.

The time program allows you to adapt DHW storage tank recharging to user needs.

The default DHW program is set to the Comfort temperature between 00:00 and 05:00 and between 14:30 and 17:00 and to the ECO temperature for the rest of the day. e

The production of domestic hot water (DHW) is started when the temperature in the tank drops to 7°C below the temperature setpoint.

The heat pump produces the domestic hot water, which is then additionally heated, if required, by the tank's electrical backup or by the boiler..

DHW production takes priority over heating and cooling.

However, if DHW production takes too long, the heat pump may decide to alternate between heating/cooling and DHW storage charging. Anti-legionella cycles can be programmed once a week.

■ Protective functions

- Anti-legionella cycle for domestic hot water.
- Frost protection: The Hydraulic unit incorporates a system frost protection function (provided the power supply to the heating pump is not interrupted).

*: Depending on options / settings

🏠 Location

▶ Installing the hydraulic unit

▼ Installation precautions



The choice of the position for installation is particularly important insofar as any later movement is a delicate operation requiring the intervention of a qualified person.

- Choose the site of the heat pump and the hydraulic unit after discussion with the customer.
- The room in which the appliance operates must comply with the prevailing regulations.
- To facilitate maintenance and to allow access to the various components, we recommend that you provide sufficient space all around the hydraulic unit.



The appliances are not fireproof and should therefore not be installed in a potentially explosive atmosphere.



Eight of hydraulic unit (full of water) = 50 Kg

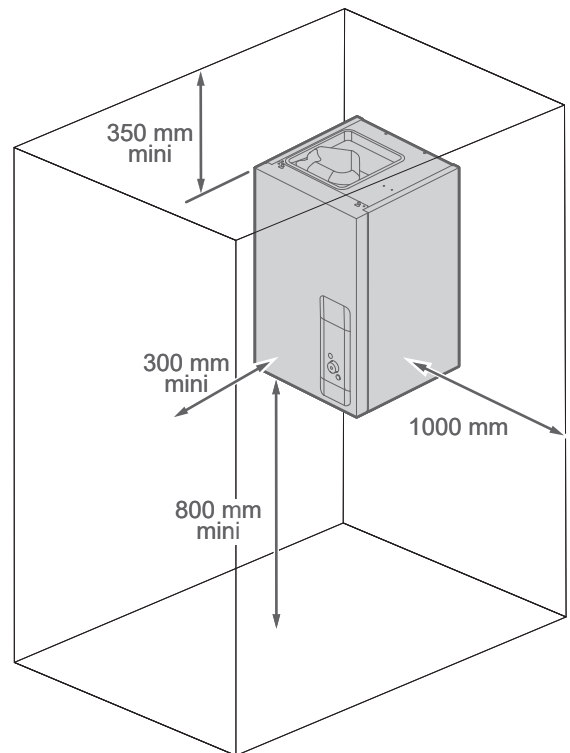

fig. 7 - Minimum installation clearances around the hydraulic unit for maintenance

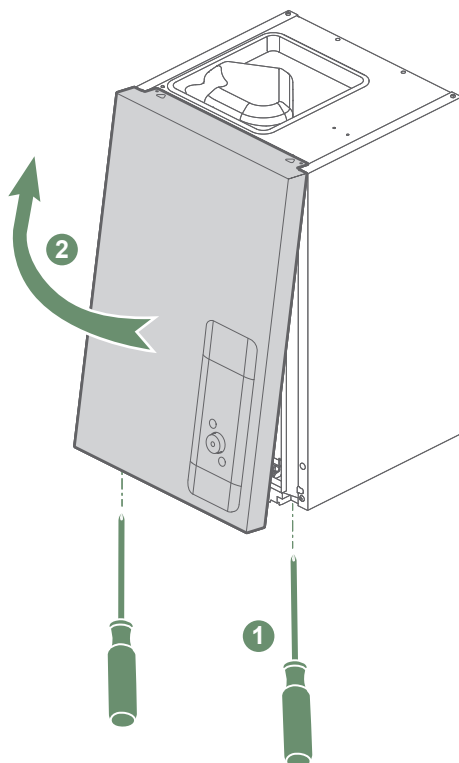

fig. 6 - Front cover opening

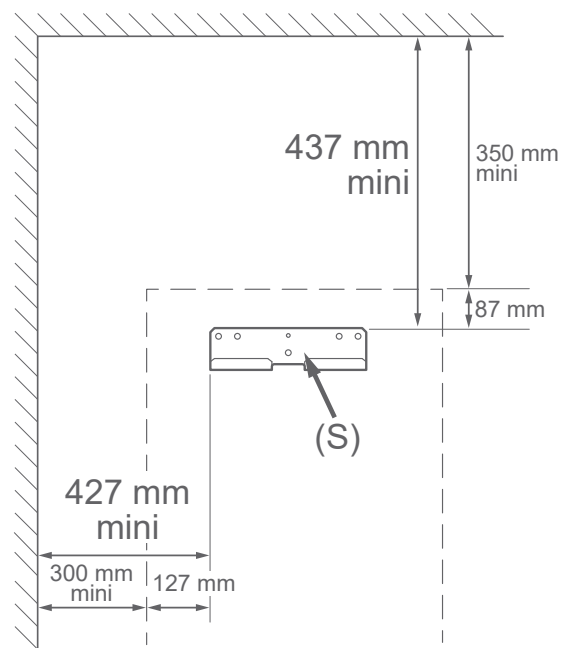

fig. 8 - Mounting bracket

Hydronic connections

i See "Appendices", page 45

► Flushing the installation



Before connecting the hydraulic unit to the installation, rinse the heating system correctly to eliminate the particles that could compromise the correct operation of the appliance.

Do not use solvents or aromatic hydrocarbons (petrol, paraffin, etc.).

In systems equipped with underfloor or ceiling heating/cooling, oxygen can lead to the formation of organic sludge. This sludge can adversely affect product performance and reliability.



To prevent sludge from forming in the system, use oxygen-tight piping (copper, PEX-OB, multi-layer, etc.).

► Outdoor unit

Connect the pipe of the outdoor unit to the hydraulic unit respecting the direction of flow.



Mandatory: Install a sediment trap (supplied) on the heating return circuit in the manner suggested.

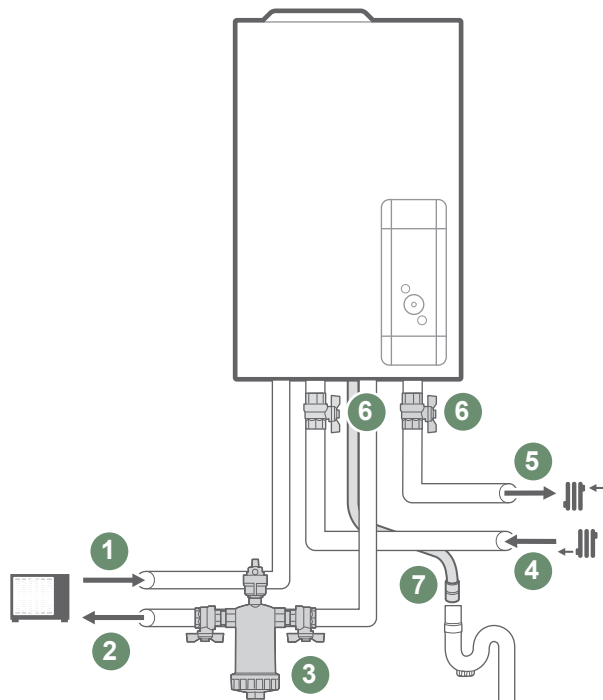

- 1 - Outdoor unit to indoor unit connection.
- 2 - Indoor unit to outdoor unit connection.
- 3 - Sediment trap.
- 4 - Heating return (1 circuit).
- 5 - Heating flow (1 circuit).
- 6 - Shut-off valve (not supplied).
- 7 - Drain pipe.



Install antifreeze valves (optional / not supplied) on the hydraulic circuit in the recommended direction.

If the antifreeze valves are triggered, check the electrical backup safety thermostat before restarting.

■ Lengths and diameters of hydraulic pipes

Tightening torque::

Ø	Tightening torque:
1/2"	25 Nm
3/4"	35 Nm
1"	45 Nm
1-1/4"	60 Nm



Max. pipe length EU/ULav30m.

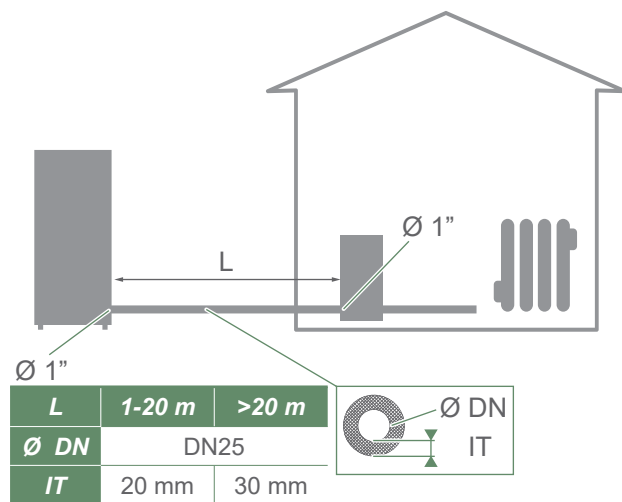

fig. 9 - Raccordements

► Heating circuit hydronic connecting

The heating circulator is integrated into the hydraulic module.

Connect the pipe of the central heating to the hydraulic unit respecting the direction of flow.

The pipe between the hydraulic unit and the heat collector must be at least 3/4 inch in diameter (20x27 mm).

Calculate the diameter of the pipes according to the flow rates and the lengths of the hydronic systems.

Tightening torque::

Ø	Tightening torque:
1/2"	25 Nm
3/4"	35 Nm
1"	45 Nm
1-1/4"	60 Nm

Connect the drains from the drain valve and the safety valve to the main sewer system.

Verify that the expansion system is correctly connected. Check the expansion vessel pressure (pre-inflated to 1 bar) and the safety valve is calibrated.

The flow rate of the installation must be at least equal to the minimum value mentioned in the table "Specification", page 17.

The installation of a regulator (other than those included in our configurations) which reduces or stops the flow through the hydraulic unit is prohibited.

► Volume of the heating system

You must maintain the minimum installation water volume. If the required water volume is not available in the heating system a buffer tank must be installed on the return pipework of the heating circuit. For systems equipped with thermostatic valve(s), **water must be able to circulate continuously (at least one open loop per circuit).**

<i>Min. volume excluding heat pump (in liters)</i>			
Model	Fan-convector	Radiator	Heating-cooling floor
Model 5	25/circuit	-	-
Model 8	25/circuit	-	-
Model 10	25/circuit	-	-

► Filling and bleeding the installation

Check the pipe fixings, tightness of the connectors and the stability of the hydraulic unit.

Check the direction in which the water is circulating and that all the valves are open.

Proceed to fill the installation.

Do not operate the circulation pump during filling.

Open all the drain valves (in the installation, hydraulic unit and outdoor unit) and the bleed valve on the hydraulic unit to expel the air contained in the pipes.

Close the drain and bleed valves and add water until the pressure in the hydronic circuit reaches 1 bar.

Check that the hydronic circuit has been bled correctly.

Check there are no leaks.

After the "Commissioning", page 23 stage, and once the machine has started, bleed the hydraulic unit again.



Precise filling pressure is determined by the water pressure in the installation.

Electrical connections



Before performing any maintenance, make sure that all power supplies have been isolated.

Electrical installation must be performed in accordance with current regulations.



The electrical diagram for the hydraulic unit is shown on [page 43](#).

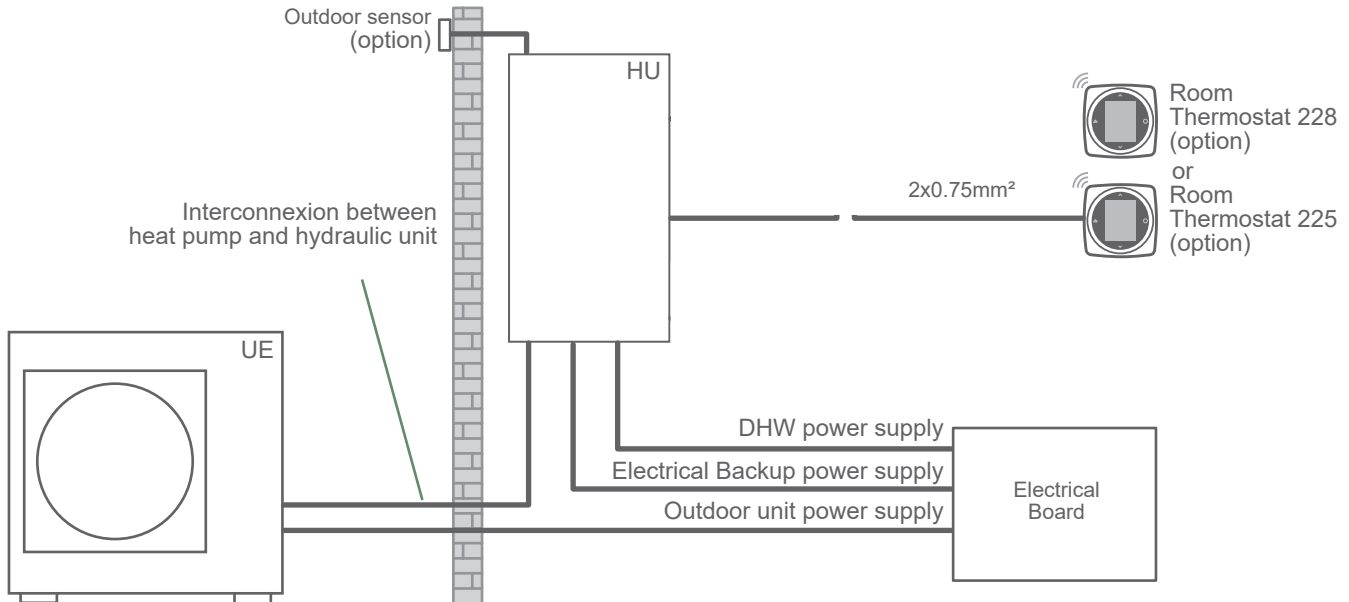

fig. 10 - Overall layout of electrical connections for a simple installation (1 heating circuit)

► Cable dimensions and protection rating

These cable dimensions are provided for information purposes only and do not exempt the installer from checking that these dimensions match requirements and comply with current standards.

■ Outdoor unit Power Supply (OU)

(* See Outdoor unit Installation manual)

■ DHW power supply

The DHW section is powered directly via a 3G1.5 mm² cable (phase, neutral, earth).

Protection by rated circuit breaker [16 A - C curve].

■ Interconnection between the hydraulic unit and the outdoor unit

The hydraulic unit communicate with the outdoor unit via a 4G1.5 mm² cable (phase, neutral, earth).

■ Electrical backup power supply

The hydraulic module includes an electric backup installed in the heat exchanger.

Electrical backup		Electrical backup power supply	
Power	Normal intensity	Connecting cable (phase, neutral, earth).	Circuit breaker rating / C curve
3 kW	13 A	3 G 1,5 mm ²	16 A
2x3 kW (option)	26.1 A	3 G 6 mm ²	32 A

► Hydraulic unit

Access the connection terminals:

- Remove the front panel.
- Switch the “main” electrical box
- Open the power control box.
- Make the connections according to the *page 43* diagram.

Do not place the sensor and power supply lines parallel to each other to avoid interference due to voltage spikes in the power supply.

Make sure that all electrical cables are housed in the areas provided for this purpose.

■ Switch the main box

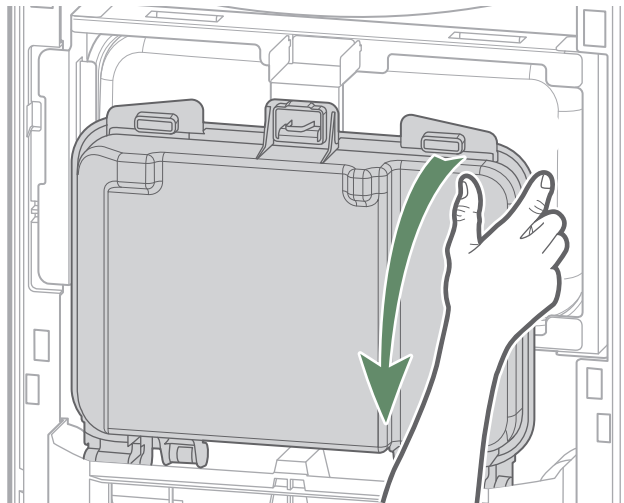

■ Access to power terminals

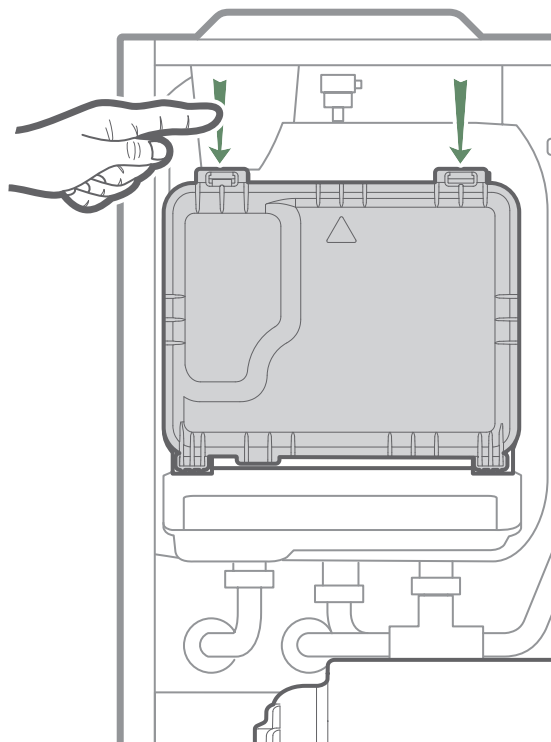

■ Access to sensor connectors

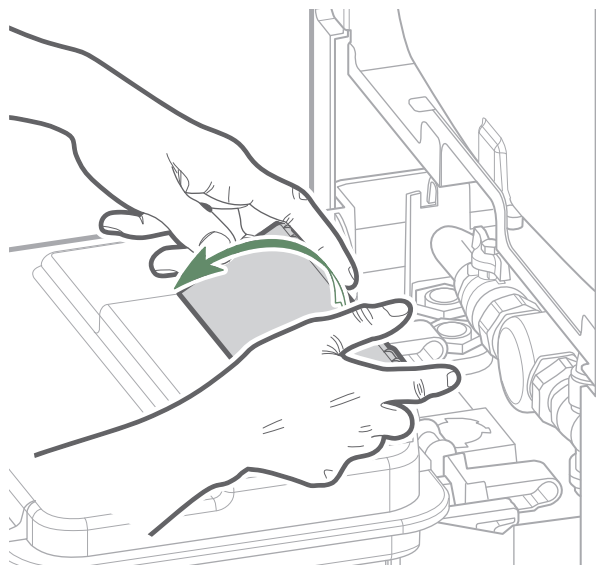

fig. 11 - Access to hydraulic unit terminals

▼ Interconnection between outdoor unit and hydraulic unit

- 1 Match up the terminal block markers on the hydraulic unit to those of the outdoor unit exactly when connecting the interconnection cables.



An incorrect connection could result in the destruction of one or other of the units.

▼ Electric heating supply

- 2 Connect the backup heater's power supply.
 - **3 kW** backup: 3G1.5 mm² cable (phase, neutral, earth) to electric panel. Protection by rated circuit breaker [16 A - C curve].
- or
- **6 kW** backup (option): 3G6 mm² cable (phase, neutral, earth) to electric panel. Protection by rated circuit breaker [32 A - C curve].

■ Electrical backup heating & OU connection terminal block

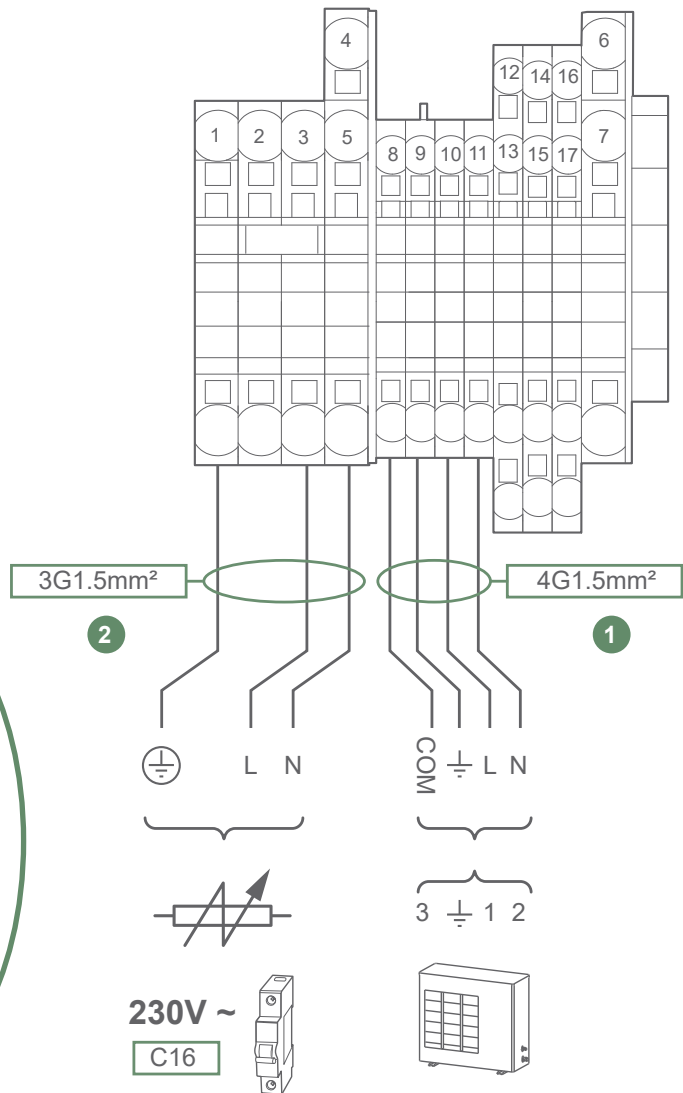
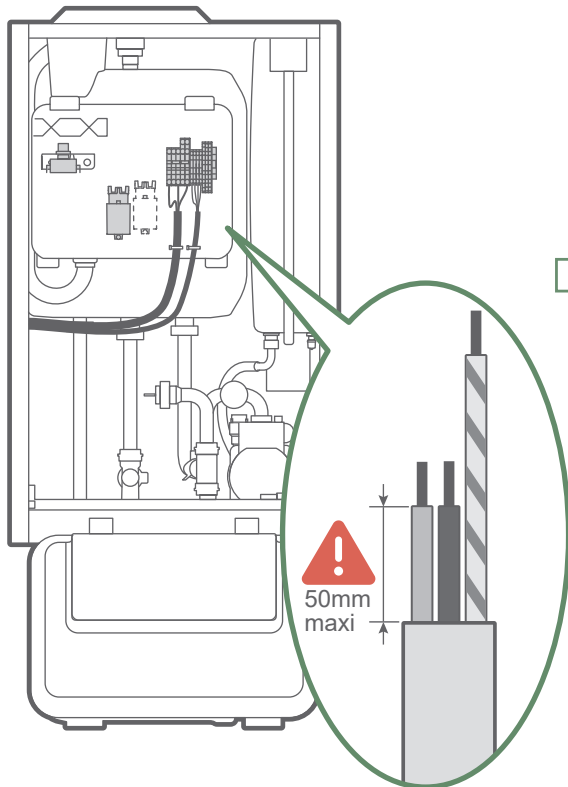

fig. 13 - Cables passage

fig. 12 - Power supplies connection

► Options

▼ Second heating circuit

→ Please refer to the instructions supplied with the 2-circuits kit.

▼ Mixed domestic hot water tank



If the hot water tank's electric backup is not equipped with a manual reset thermostat, it is necessary to add one.

If the system is equipped with a mixed sanitary tank:

→ Refer to the instructions supplied with the sanitary kit.

→ Refer to the instructions supplied with the DHW combi storage tank.

ECS kit power supply 230V~ protected by circuit breaker [16 A curve C]

▼ Faults outside the heat pump

All information devices (floor/ceiling heating safety device, thermostat, pressure switch, etc.) may indicate an external problem and stop the heat pump.

4 Connect the external device to **Sensor Connector**.

▼ Room thermostat installation

→ Please refer to the instructions supplied with the room thermostat.

10 Room Thermostat 1 (wired) on the **Sensor terminal**.

11 Room Thermostat 2 (wired) on the **Sensor terminal**.

12 24VDC power supply for wireless room sensor (wired power supply / radio communication) to the **power supply terminal** block.

Fan-convector zone

If the system is equipped with dynamic fan convectors/ radiators, do not use a room thermostat.

► Outdoor sensor

→ Please refer to the instructions supplied with the outdoor sensor.

The Outdoor sensor is required for the correct operation of the heat pump, especially in the absence of a room thermostat.

Place the sensor on the coldest part, generally the northern or north-eastern side.

In any case, it must not be exposed to the morning sun.

It must be installed so that it is easily accessible but at least 2.5 m from the ground.

Avoid sources of heat such as chimneys, the tops of doors or windows, nearby extraction ducts, underneath balconies and porches, that would insulate the sensor from the variations in the temperature of the air outdoors.

8 Connect the outdoor sensor to the **Sensors terminal**.

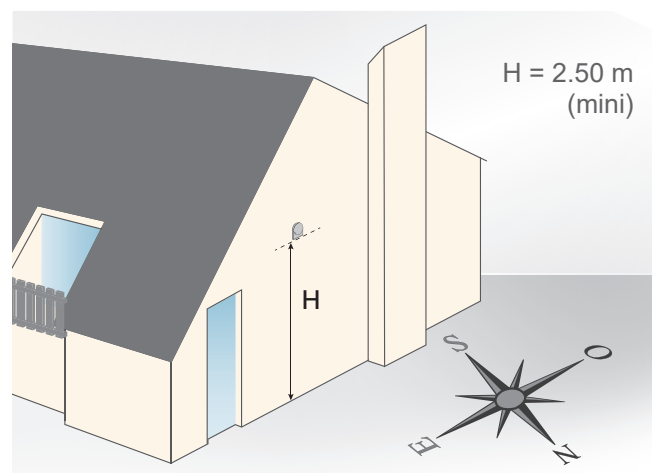

■ Sensor Connector (main box)



fig. 14 - Sensors connections

▼ Control extension board

➔ Please refer to the instructions supplied with the extension kit.

It is possible to link the operation of the heat pump to specific contracts, in order to produce domestic hot water (DHW) at the cheapest times of the day:

Off-peak hours

- Connect the “Power Provider” contact to input **DL1 of the T70 connector**.
- In the menu Installed Options set “*External input 1: Type of functions*” to “Off-peak hours”.
- By default: 230V sur DL1 = information “Off-peak hours” activated ➔ the DHW is produced at the Comfort setting.

PhotoVoltaics

- Connect the “Power Provider” contact to input **DL1 of the connector T70**.
- In the menu Installed Options, set “*External input 1: Type of functions*” to “PhotoVoltaics”.
- By default: 230V on DL1 = information “Photovoltaics” activated ➔ the electric backup for the domestic hot water tank is activated up to a maximum temperature of 65°C.

Load shedding or peak shaving

- Connect the load-shedding device to input **DL2 of the connector T70**.
- In the menu Installed Options, set “*External input 1: Type of functions*” to “Power shedding”.
- By default: 230V on DL2 = load shedding in progress ➔ Heat pump and DHW auxiliaries are stopped. The heat pump is enabled or disabled according to the “If power shedding order”.
- The heat pump and DHW backup are stopped. The heat pump is enabled or disabled according to the “If reset / load shedding command” setting.

Smart Grid

- Connect the 2 power contacts “Power suppliers” to inputs **DL1 and DL2 of the connector T70**.
- In the menu Installed Options, set “*External input 1: Type of functions*” to “Smart Grid”.
- By default, “Smart Grid” operation is the following.

DL1	DL2	Behaviour
0V	0V	Normal
230V	0V	Idem Power shedding
0V	230V	Idem Off-peak hours
230V	230V	Triggering boost DHW

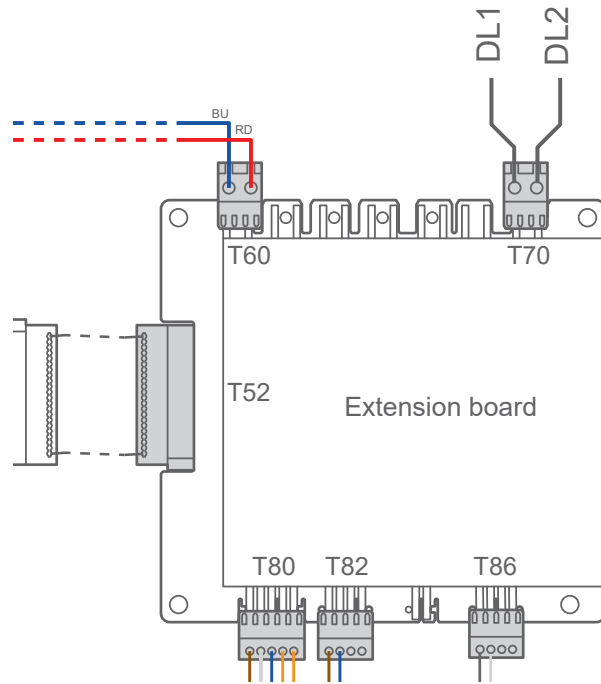

External control (“Switch to cooling”)

It is possible to control the changeover from “Heating Mode” to “Cooling Mode” via an “external control unit”.

- Connect the external control box to the input **DL2 of the connector T70**.
- In the menu Installed Options, set “*External input 1: Type of functions*” to “Switch to cooling”.
- Heating/cooling mode by default:
 - 0V on DL2 = heating mode.
 - 230V on DL2 = cooling mode.
- Demand management by circuit mode: via room thermostat input(s).



Do not connect the ON/OFF thermostat to the External control setting.







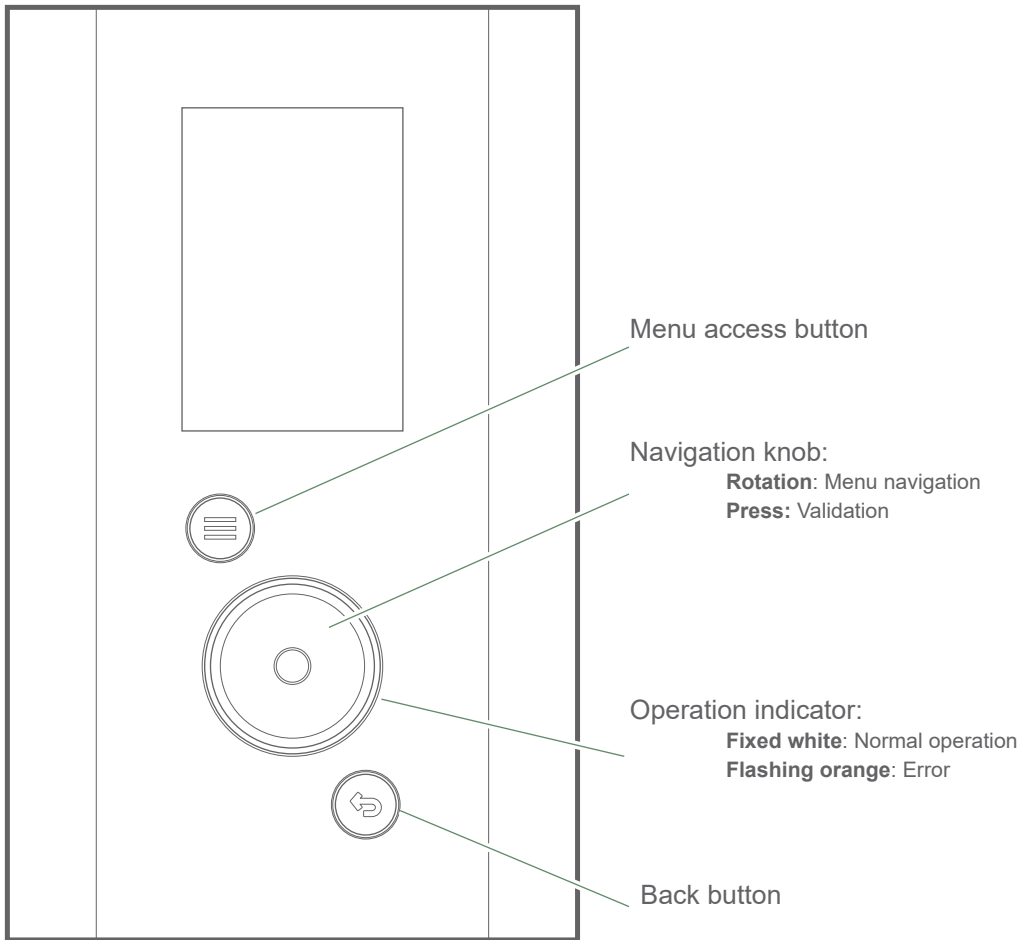

A series of horizontal dotted lines spanning the width of the page, providing a guide for handwriting practice.



Controller Interface

► User Interface







► Display Description

- 1  Connectivity
-  Attenuation mode
-  Planned absence
-  Emergency mode
-  Outdoor temperature
-  Installer Menu

- 2  Normal operation
-  Warning
-  Error

- 3  Pressure indicator

- 4 **55°C** DHW setpoint
-  Remaining hot water





-  DHW on
-  Heating in progress
-  (Grey) Off / Frost protection

- 5 **43°C** Flow temperature setpoint





Operation :

-  (Orange) Heating
-  (Blue) Cooling
-  (Grey) Off / Frost protection

Mode :

-  Heating
-  Cooling
-  Absence
-  Floor drying

Product by :

-  Heat pump
-  Electric backupvcv
-  Heat pump + Electric backup
-  Heat pump + Boiler
-  Boiler

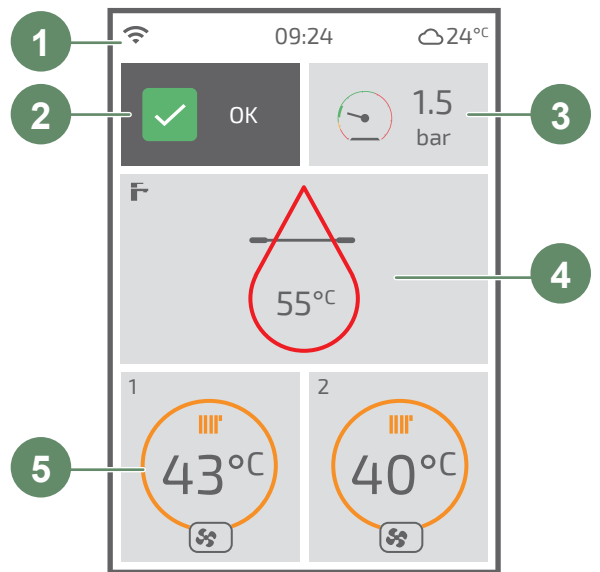

🌡️ Flow setpoint

▶ WITH room thermostat

Heat pump operation is controlled by the room thermostat.

The circuit water temperature setpoint is calculated by the thermostat and then communicated to the heat pump.

Settings on thermostat

- **Heating settings**
 - Mode choice.
 - Set room setpoints.
 - Time programming setting

▶ WITHOUT room thermostat

The heat pump's operation is subject to the temperature control.

The heating circuit water temperature setpoint is adjusted according to the outdoor temperature.

If there are thermostatic valves on the installation, these must be fully open or set higher than the normal temperature setpoint..

▼ Setting

Flow temperature setpoint setting

This setting is made directly via the interface.

Heating / Cool

Circuit 1

Heating

👤
 Circuit 1
 Heating

Flow setpoint limits
 Min: 12°C Max: 50°C

Temperature control
 Weather compensation

Flow temp at -10°C outside
40°C

Flow temp at 20°C outside
20°C

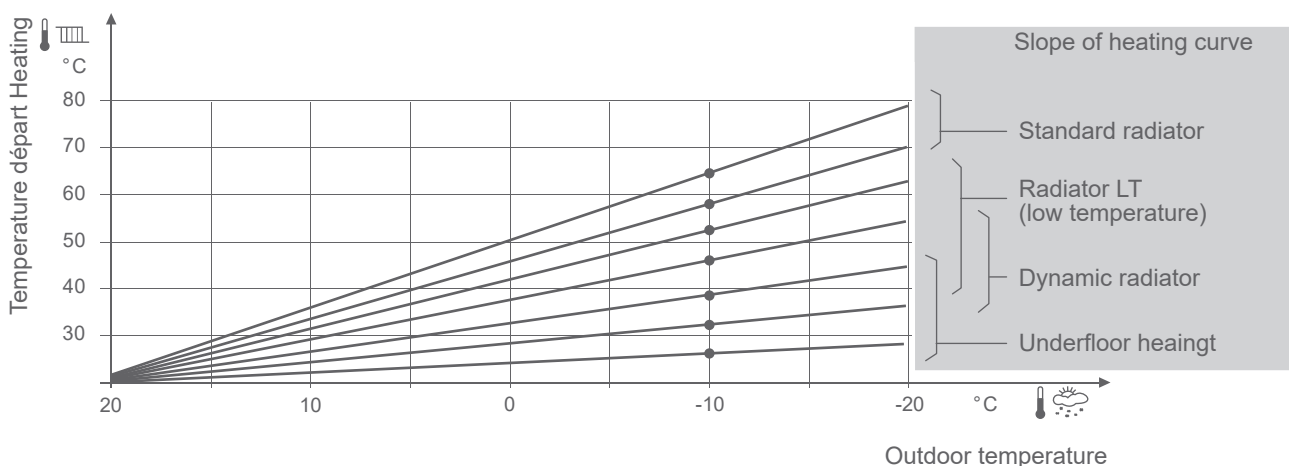

fig. 15 - Slope of heating curve

⚙️ Commissioning

▶ Pre-commissioning checks

• Hydronic circuit

- Make sure the system has been flushed.
- Check water flow direction and that all valves are open. Carry out a tightness check on the entire system.

• Electrical circuit

- Check that the phase-neutral polarity of the power supply is correct.
- Check that all equipment is connected to the correct terminals

▶ First commissioning

Switch on the system's main circuit breaker. When commissioning for the first time (or in winter), to allow the compressor to warm up, switch on the system's main circuit breaker (outdoor unit power supply) a few hours before testing. During commissioning, each time the main circuit breaker is switched off and then on again, the outdoor unit will take approximately 4 minutes to start up, even if the control is in heating mode.



If commissioning takes place in cold weather (hydraulic temperature below 17°C), the electric backup is used alone to preheat the hydraulic circuit (no use of the UE).



When first used, a slight odor of hot plastic may occur.

▶ Easy Start

Choose language, set date and time.
Answer questions from Easy Start.

Easy Start	
Outdoor unit model	XX kW
Electrical heater	3kW
Number of circuits	1
Circuit X: Name	Circuit 1
Circuit X: Emitters type	Radiator
Circuit X: Comfort delivered	Heating

► Hydraulic unit purging

When first switched on, the circulator and directional valve start up to automatically purge the system (heating and sanitary circuits).

The user interface displays the remaining purge time. Never interrupt this cycle (During the purge cycle, the circulator alternates between operating and stopping phases lasting 5 seconds (5 s on, 5 s off...). The valve alternates every 30 seconds between the heating and sanitary circuits.)

- Open all system drains to evacuate air from the pipes.
- Close the bleed valves and add water until the hydraulic circuit pressure reaches 1.5 bar.

The exact filling pressure depends on the height of the system.

- Check for leaks.

To start a new automatic purge cycle:

Additional Functions **Air purge cycle**

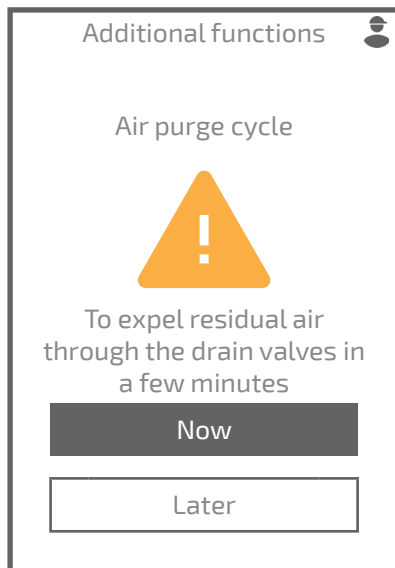

► Sludge pot cleaning

Immediately after commissioning, clean the sludge pot filter (remove any waste from the installation: gaskets, filings, etc.).



Before starting work, check that the working environment is safe. Carry out maintenance operations with the unit switched off and the system cooled to room temperature.

- Close both valves. Open steam trap.
- Carefully unscrew cover.
- Water begins to drain gradually. Ensure that this water is collected in an appropriately sized container.
- When the water stops flowing, remove the magnet cover completely.
- Pull out the filter sheath to remove any ferrous particles.
- Clean with water and rinse thoroughly under the tap to remove all impurities.
- Check the condition of the O-ring and replace it if damaged.
- Reassemble in reverse order.



Make sure there are no signs of leakage before recommissioning.

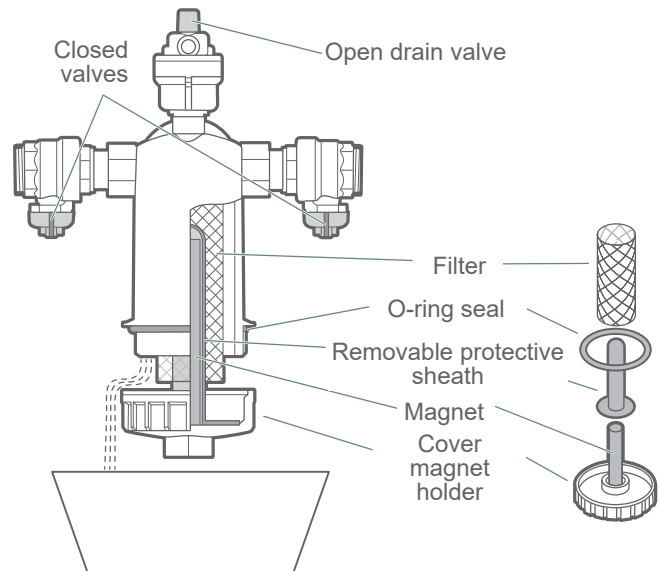
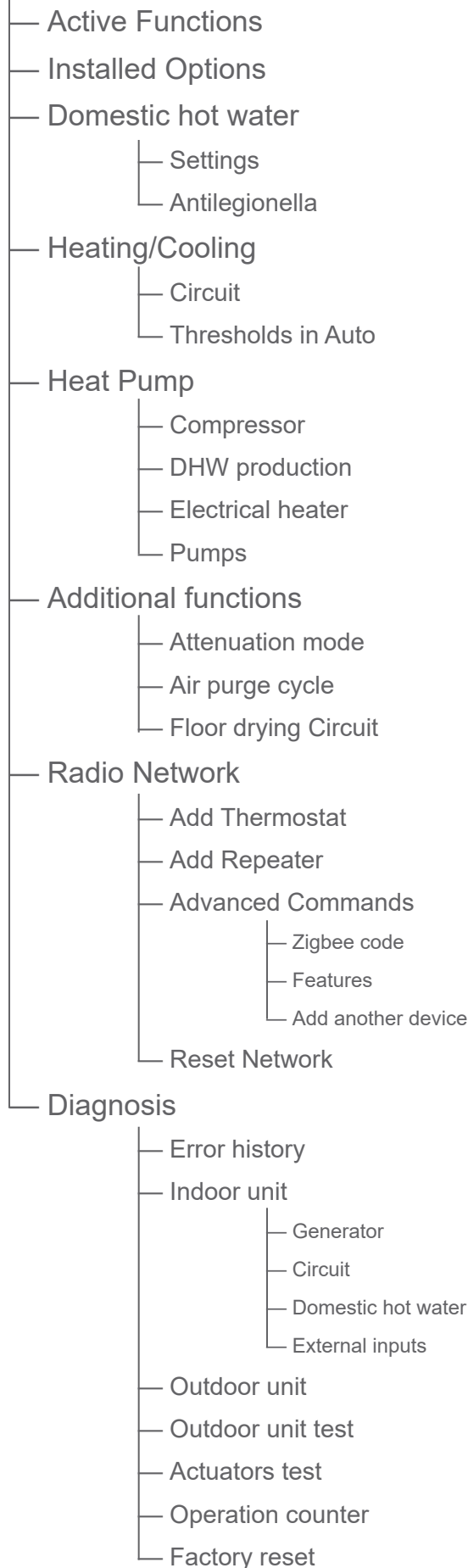

fig. 16 - Sludge pot cleaning

Controller menu

► Menu structure

Installer menu



Some settings (or menus) may not appear. They depend on the system configuration (depending on option)



Default settings are underlined in the explanations.
Values shown on screens are not contractual.

► Active Functions

Active Functions

The *Active Functions* page provides information on services in operation and allows you to modify their status..

- **Domestic hot water:**

On / Off

- **Circuit 1 / 2:**

On / Off / Heating/Cooling / Auto

- **Emergency mode:**

Enabled / Inactive

Active Functions	
Domestic hot water	<u>Off</u>
Circuit 1	<u>Auto</u>
Circuit 2	<u>Heating</u>
Emergency mode	<u>Inactive</u>

► Installed Options

Installed Options

The installed options are set during commissioning. However, these can be modified from the *Installed Options* menu.

- **Outdoor unit model:**
XX kW
- **Electrical heater:**
None / 3kW / 3kW + 3kW
- **Number of circuits:**
1 / 2
- **Circuit X: Name:**
Circuit 1 / Day / Night / Ground floor / Floor / Living rooms / Bedrooms
- **Circuit X: Emitters type:**
Radiators / Floor / Ceiling / Fan convector
- **Circuit X: Comfort delivered:**
Heating / Heating and Cooling
- **Outside temperature:**
(Information depending on outside sensor location)
From Outdoor Unit / From remote sensor
- **Safety input:**
Normally Open / Normally Closed
- **External input 1: Type of functions:**
None / Off-peak hours / PhotoVoltaics / Smart Grid
- **External input 1: Switching settings:**
0V / 230V
- **External input 2: Type of functions:**
None / Power shedding / Cooling switch / Smart Grid
- **External input 2: Switching settings:**
0V / 230V
- **If power shedding order/ Power shedding:**
Compressor Allowed/ Compressor Forbidden

Installed Options 	
Outdoor unit model	<u>XX kW</u>
Electrical heater	<u>9kW</u>
Number of circuits	<u>1</u>
Circuit X: Name	<u>Circuit 1</u>
Circuit X: Emitters type	<u>Radiator</u>
Circuit X: Comfort delivered	<u>Heating</u>
Outside temperature	<u>From Outdoor Unit</u>
Safety input	<u>Normally Open</u>
External input X: Type of functions	<u>None</u>
External input X: Switching settings	<u>230V</u>
If power shedding order/ Power shedding	<u>230V</u>

► Domestic Hot Water

Domestic hot water

Settings

- Heating mode:

Confort: provides maximum comfort by ensuring a large hot water at all times.

Eco: provides maximum savings in heating and sanitary comfort.

- Temperature:

47°C ... 55°C ... Temperature max

- Temperature max:

Temperature ... 65°C

- Forced load:

Auto / Manuel

- Forced load 1 / 2:

Set time

Domestic hot water Settings	
Heating mode	<u>Confort</u>
Temperature	<u>55°C</u>
Max. temperature	<u>65°C</u>
Forced load	<u>Manuel</u>
Forced load 1	<u>10:00</u>
Forced load 2	<u>20:00</u>

Domestic hot water

Antilegionella

- Weekly protection:

Enabled / Inactive

- Time of cycle:

Set day and time

- Temperature:

55°C ... 60°C ... 65°C

Domestic hot water Antilegionella	
Weekly protection	<u>Enabled</u>
Time of cycle	<u>Thursday 04:15</u>
Temperature	<u>65°C</u>

► Heating/Cooling

Heating/Cooling	Circuit 1	Heating
-----------------	-----------	----------------

- **Flow setpoint limits:**
 Min: 10°C ... 20°C
 Max: 20°C ... 65°C
- **Temperature control:** (See "⚙️ Flow setpoint")
 Weather compensation / Smart Adapt
- **Flow temp at -10°C outside:**
 Flow temp at 20°C outside ... 80°C
- **Flow temp at 20°C outside:**
 10°C ... Flow temp at -10°C outside
- **Room temperature influence:**
 10% ... 50% ... 90%

Circuit 1 Heating	
Flow setpoint limits :	Min: <u>12°C</u> Max: <u>50°C</u>
Temperature control	Weather compensation
Flow temp at -10°C outside	<u>40°C</u>
Flow temp at 20°C outside	<u>20°C</u>
Room temperature influence	<u>50%</u>

Heating/Cooling	Circuit 1	Cooling
-----------------	-----------	----------------

- **Flow setpoint limits:**
 Min: 7°C ... 35°C
 Temperature control: (See "⚙️ Flow setpoint")
 Weather compensation / Smart Adapt
- **Flow temp at 25°C outside:**
 Flow temp at 35°C outside ... 35°C
- **Flow temp at 35°C outside:**
 7°C ... Flow temp at 25°C outside
- **Room temperature influence:**
 10% ... 50% ... 90%

Circuit 1 Cooling	
Flow setpoint limits :	Min: <u>18°C</u>
Temperature control	Weather compensation
Flow temp at 25°C outside	<u>20°C</u>
Flow temp at 35°C outside	<u>16°C</u>
Room temperature influence	<u>50%</u>

Heating/Cooling	Thresholds in Auto
-----------------	---------------------------

- **Switch to heating at:**
 15°C ... 20°C
- **Cooling switch at:**
 21°C ... 30°C

Heating/Cooling Thresholds in Auto	
Switch to heating at	<u>19°C</u>
Cooling switch at	<u>24°C</u>
Outside temperature	26°C selected for Auto

► Heat Pump

Heat Pump

Compressor

- **Minimum off time:**
3 min ... 8 min ... 20 min
- **Overrun:**
10 s ... 30 s ... 600 s

Heat Pump Compressor	
Minimum off time	<u>10 min</u>
Overrun	<u>30 s</u>

Heat Pump

DHW production

- **Max. DHW charging time:**
90 min ... 120 min ... 180 min
- **Back to Heating/Cooling:**
10 min ... 30 min ... 120 min

Heat Pump DHW production	
Max. DHW charging time	<u>180 min</u>
Back to Heating/Cooling	<u>20 min</u>

Heat Pump

Electrical heater

- **Outside temperature threshold:**
Inactive / -15°C ... 2°C ... 10°C
- **Switching threshold:**
0°C min ... 10°C min ... 500°C min

Heat Pump Electrical heater	
Outside temperature threshold	<u>°C</u>
Switching threshold	<u>0°C min</u>

Heat Pump **Pumps**

- **Outdoor unit Pump speed**
60 % ... 100 %
- **System Pump speed:**
70 % ... 100 %
- **Circuit 2 Pump speed:**
70 % ... 100 %

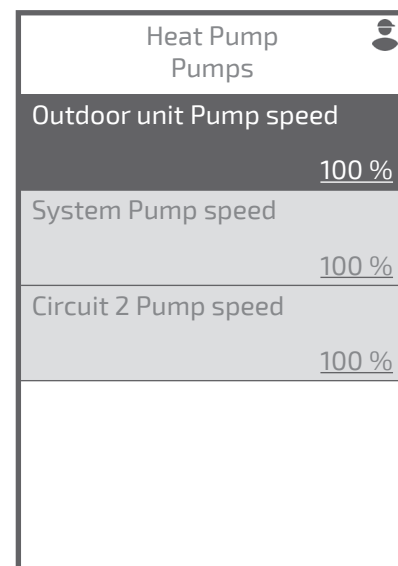

► **Additional functions**

Additional functions **Attenuation mode**

- **Compressor limitation:**
Enabled / Inactive
- **Max allowed speed:**
10% ... 95%
- **Active as:**
Outside > -15 °C ... 10 °C
- **Period 1 / 2 / 3:**
Set period

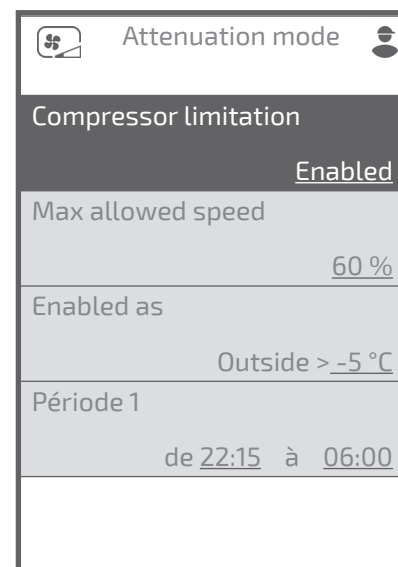

Additional functions **Air purge cycle**

The air purge cycle takes approximately 4 minutes.
Never interrupt this cycle.
(During the purge cycle, the circulator alternates between operating and stopping phases lasting 5 seconds (5 s on, 5 s off...)).
The valve alternates every 30 seconds between the heating and sanitary circuits.)
Open all system drains to evacuate air from the pipes.

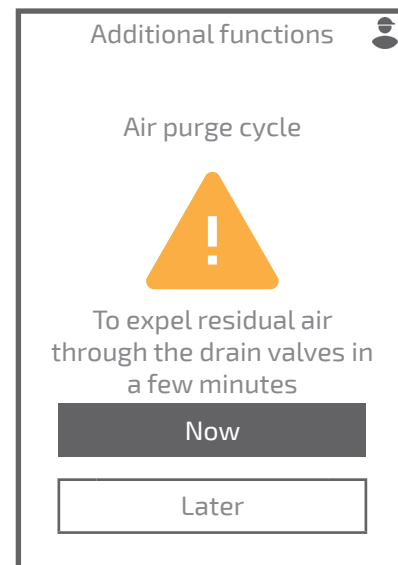

- Drying:*Off / Manual for 25 days / Progressive 18d + Shock 7d***- Flow temperature setpoint:**

20°C ... 55°C

Observe the building manufacturer's standards and instructions!
Correct operation of this function is only possible with a correctly installed system (hydraulics, electricity and settings)!

The function can be interrupted early by setting to *Off*.

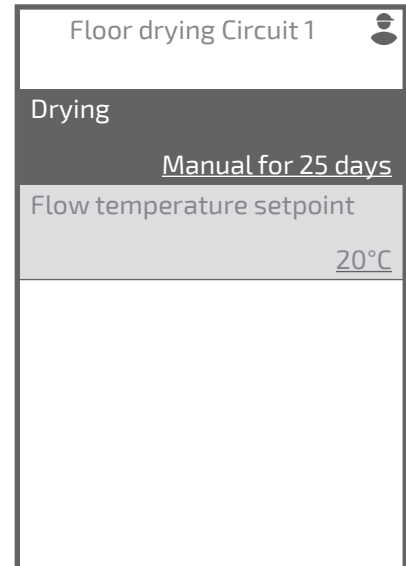
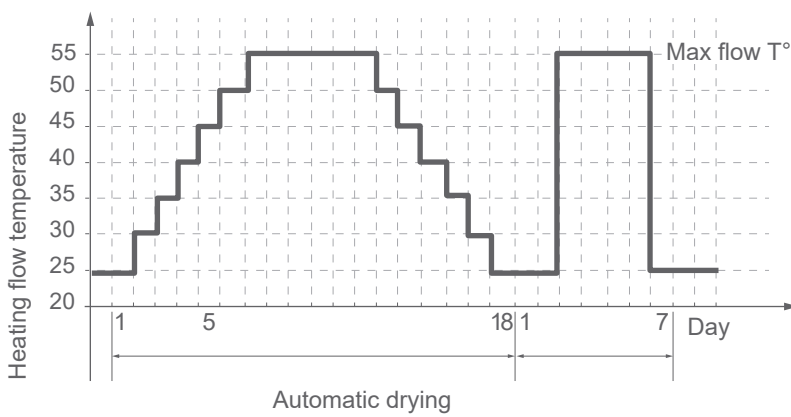

► Radio Network

→ Please refer to the room sensor installation manual.

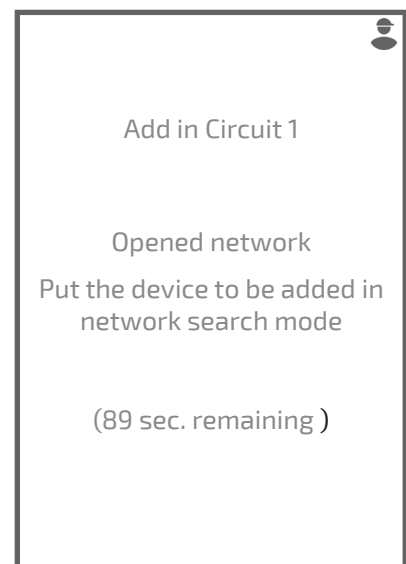

Install repeater halfway between device and Thermostat

→ Please refer the Repeater installation manual.

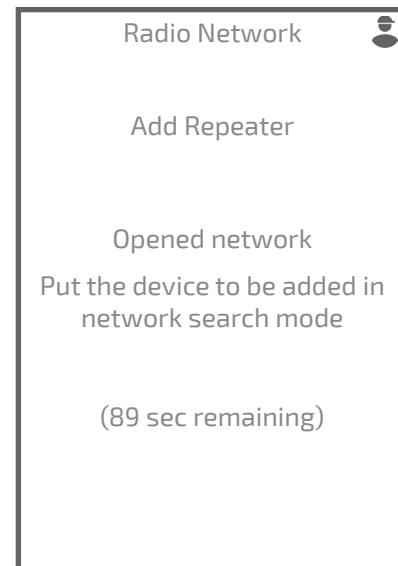

Provides status and technical information on the radio network.

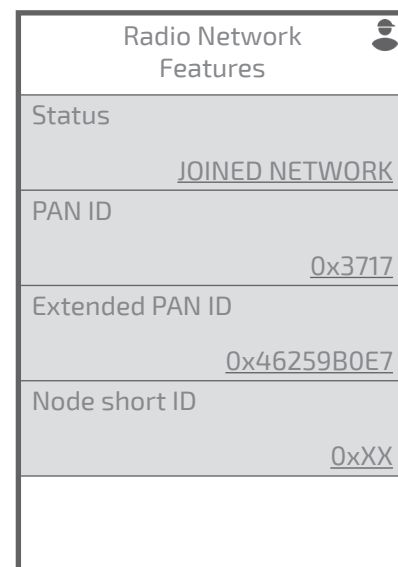

Reset cancels all pairings.

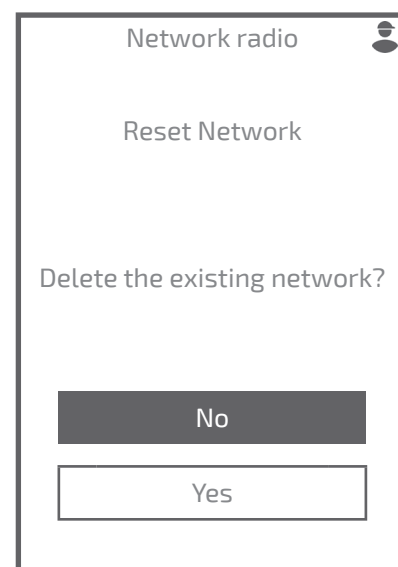

► Diagnosis

Diagnosis

Error history

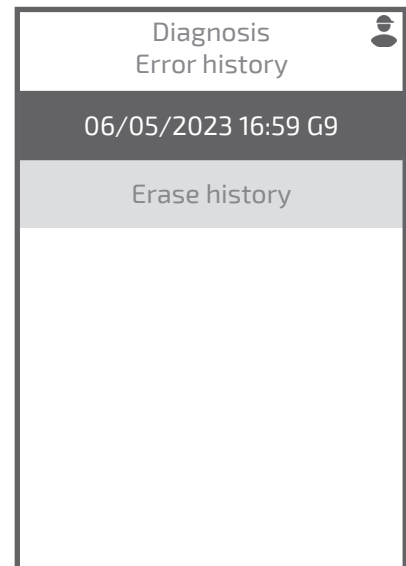

Diagnosis

Indoor unit

Outdoor unit

Operation counters

Displays the status of various functions and actuators.

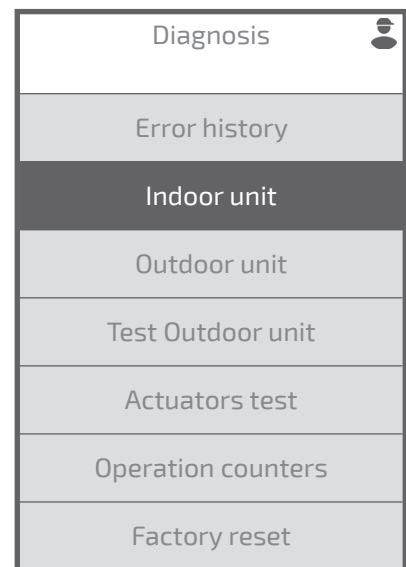

Diagnosis

Test Outdoor unit

- **Mode:**

Heating / Froid

- **Compressor modulation:**

Off / 100%

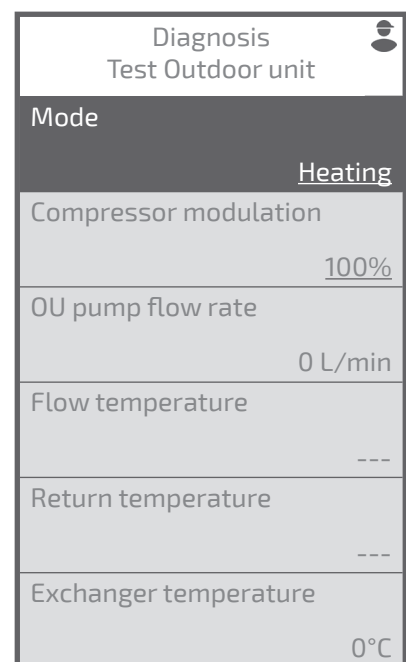

Diagnosis **Actuators test**

- **System pump Outdoor unit:**
Off / 60% ...100%
- **System pump:**
Off / 70% ...100%
- **Electrical heater:**
Off / On
- **Circuit 2 Pump speed:**
Off / 70% ...100%
- **Mixing valve circuit 2:**
Closed / Open 10% ...100%
- **DHW electrical heater:**
Off / On
- **Directional valve:**
Heating / Domestic hot water / Middle position



Don't forget to set the parameters to *Off* after testing.

Diagnosis	
Test Outdoor unit	
System pump Outdoor unit	
	<u>Off</u>
OU pump flow rate	0 L/min
System pump système	<u>Off</u>
Electrical heater	<u>Off</u>
Flow temperature	---
Return temperature	---
Circuit 2 Pump speed	<u>Off</u>
Mixing valve circuit 2	<u>Closed</u>
DHW electrical heater	<u>Off</u>
Directional valve	<u>Heating</u>
Tank temperature	0°C

Diagnosis **Factory reset**

The factory settings stored in the controller override and cancel any custom programs.
Customized settings are lost.

Back to Easy Start.

Diagnosis
Factory reset
Warning! Return to the default factory configuration?
<input type="button" value="No"/>
<input type="button" value="Yes"/>

Fault Diagnostiser

► Faults in the Hydraulic unit

Error codes	Description	Probable causes	Proposed actions
10	Communication error with controller board.	Loss of connection between controller and display	Check wiring between T24 and display.
G1	Outdoor temperature sensor faulty..	Loss of connection between controller and outdoor unit	Check wiring between T26 and interface board.
G2	External safety input.	External safety trip	-
G6.XX	Outdoor unit error.	See details in "Outdoor unit errors"	-
G7	Flow temperature sensor faulty.	Short circuit.	Check sensor wiring. Replace sensor.
G8	Return temperature sensor faulty.	Probe disconnected or cut. Faulty probe.	
G9	Water pressure sensor faulty.	Other fault	
G11	Water pressure too low.	Lack of water in the circuit.	Add water to the circuit.
G12	Water pressure too high.	Too much water in the circuit.	Drain water slightly from the circuit.
G14	System circulator faulty.	Lack of water in the circuit. Circulator undervoltage	Top up water supply. Check system circulator supply.
G15.XX	System circulator faulty.	System circulator faulty	Check circulator wiring. Replace circulator.
G16	Directional valve faulty.	Directional valve faulty.	Check valve wiring. Replace valve.
G18	Circuit 2 temperature sensor faulty.	Short circuit. Sensor disconnected or cut.	Check sensor wiring. Replace sensor.
G22	DHW temperature sensor faulty.	Faulty sensor. Other fault.	
G27	Abnormally long anti-legionella cycles	Anti-legionella temperature setpoint not reached.	Check ECS backup wiring.
G29	Outdoor unit communication lost.	Loss of connection between outdoor unit.	Check wiring between T26 and interface board.
G30	Zone 1 room thermostat communication lost.	Wiring problem between room sensor and control.	Check wiring.
G31	Zone 2 room thermostat communication lost.		
G32	Zone 3 room thermostat communication lost.		
G45	Loss of remote outdoor temperature sensor.	Short circuit. Probe disconnected or cut. Faulty probe. Other fault.	Check sensor wiring. Replace sensor.
G46	System circulator communication lost.	Short circuit. Circulator disconnected. Circulator defective.	Check circulator wiring (communication and power supply). Replace circulator.



Before performing any maintenance, make sure that all power supplies have been isolated.

Stored energy: after cutting off the power supplies, wait for 10 minutes before accessing the internal parts of the equipment.

When the heat pump is not powered up, frost protection is not guaranteed.



► Outdoor unit error

■ Additional error codes (G6.XX) visible on display and/or error codes on interface board (indoor unit).

x N: Indicator flashes N times.

Display Error Code (G6.XX)	Error code	Carte Interface		Error label
		Green LED	Red LED	
0	11	x 1	x 1	Serial communication error after operation.
1		x 1	x 1	Serial communication error during operation.
-	23	x 2	x 3	Different combination of indoor and outdoor unit.
22	32	x 3	x 2	Command error UART communication.
-	62	x 6	x 2	Outdoor unit communication error.
-	65	x 6	x 5	IPM error.
5	71	x 7	x 1	Discharge temperature sensor error.
6	72	x 7	x 2	Compressor temperature sensor error.
7	73	x 7	x 3	Heat exchanger temperature sensor error (intermediate).
8		x 7	x 3	Exchanger temperature sensor error (output).
9	74	x 7	x 4	Outdoor temperature sensor error.
12	78	x 7	x 8	Expansion valve temperature sensor error.
25	79	x 7	x 9	Outdoor unit water temperature sensor error.
13	84	x 8	x 4	Current sensor error.
14	86	x 8	x 6	High-pressure sensor error.
		x 8	x 6	Pressure switch sensor error
15	94	x 9	x 4	Trigger detection.
16	95	x 9	x 5	Detection of compressor rotor position error.
17	97	x 9	x 7	Outdoor unit fan error.
24	9B	x 9	x 11	Circulator error.
18	A1	x 10	x 1	Discharge temperature protection.
19	A3	x 10	x 3	Compressor temperature protection.
20	A5	x 10	x 5	Abnormal low pressure.
27	AE	x 10	x 14	Hydraulic flow error.

Installation maintenance



Before performing any maintenance, make sure that all power supplies have been isolated.

Stored energy: after cutting off the power supplies, wait for 10 minutes before accessing the internal parts of the equipment.

When the heat pump is not powered up, frost protection is not guaranteed



► Preventive maintenance operations

	OK	Non-compliant
General Checks		
Clearance around the outdoor unit		
Presence of floor or wall support		
Fixing the support to the ground (if caught in the wind)		
Condensate drainage under the outdoor unit		
Absence of corrosion impacting stability		
Condition of the fins (crushed to straighten)		
Removal of foreign bodies (leaves, moss, dust, etc.)		
Cleaning the battery		
Fixing the fan to its support		
Free rotation of the fan (no friction)		
Electrical Checks		
Presence and compliance of electrical protections (see manual)		
Checking the electrical connections and tightening (terminal blocks, terminals, connectors)		
Earth connection		
Testing differential protection		
Fixing the cables in the grommets		
Refrigeration Checks		
Checking the apparent tightness (traces of oil)		
Checking tightness with leak detector (according to regulations)		
Checking the presence and condition of the heat insulation		
Hydraulic Checks		
Checking the presence and condition of the filling disconnecter		
Checking the presence and condition of the insulation		
Sealing of connections		
Checking the trap(s)		
Operating safety valve(s)		
Cleaning filter and sediment trap if present		
Measuring the pH of heating water (neutral)		
Checking the water quality of the heating and DHW circuit (absence of sludge and scale)		
Checking the expansion tank pressure (measured when empty of water)		
Checking the anti-freeze valve elements (according to the manufacturer's recommendations / if equipped)		
Checking the glycol concentration in the heating circuit (if concerned)		
Checking and adjusting the DHW thermostatic mixer (if equipped)		
Maintenance of the DHW tank if hard water is present (if equipped)		
Checking the ACI anode supply voltage (if equipped)		
Checking and adjusting the pressure of the heating circuit (depending on the installation)		

	OK	Non-compliant
Tests and readings		
Heating electrical backup operating tests		
DHW electrical backup operating tests (if present)		
Circulating pump operating tests		
Mixing valve operating tests (if 2 heating circuits)		
Directional valve operating tests (if ECS)		
Boiler connection operating tests (if relief kit)		
Thermal safety operating tests (floor heating/cooling)		
Checking the appliance's sensors (consistency of values, visual appearance)		
Absorbed intensity(s) (conformity of the value according to model)		
Supply voltages (conformity of value depending on model)		
Readings and checks of Overheating T° between 0 and 5°C		
Readings and checks of subcooling T° between 5 and 10°C		
Readings and checks of Delta T° on the air between 5 and 10°C		
Readings and checks of Delta T° on the water between 4 and 8°C		

► Basic hydraulic layout

■ 1 heating circuit

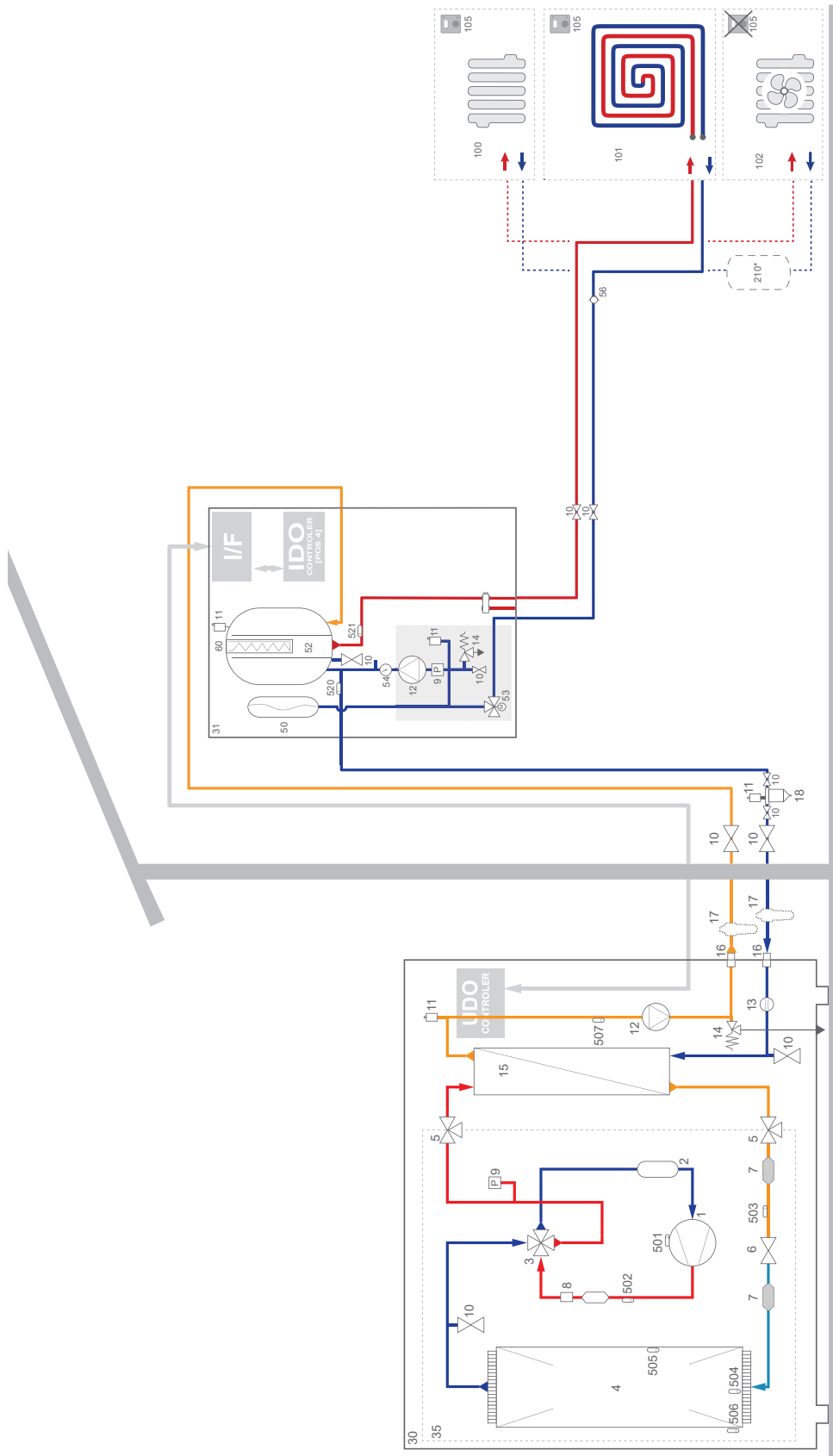

- 1 - Compressor
- 2 - Accumulator
- 3 - 4-way valve
- 4 - Heat exchanger (Evaporator)
- 5 - 3-way valve
- 6 - Expansion valve
- 7 - Filter
- 8 - Pressure switch (On/Off)
- 9 - Pressure sensor (Value)
- 10 - Valve
- 11 - Bleeder valve
- 12 - Circulating pump

- 13 - Flowmeter
- 14 - Pressure relief valve (PRV)
- 15 - Refrigerant to Water Heat Exchanger
- 16 - Connection
- 17 - Antifreeze valve
- 18 - Sediment trap
- 30 - Outdoor unit
- 31 - Hydraulic unit 1 service
- 50 - Expansion vessel
- 52 - Decoupling bottle
- 53 - Directional valve
- 54 - Manometer

- 56 - Non return valve
- 60 - HP Electrical backup
- 100 - Radiator
- 101 - Heating floor
- 102 - Dynamic radiator (fan-convector)
- 105 - Room thermostat
- 210 - Buffer tank
- 501 - Compressor temp. sensor
- 502 - Discharge temp. thermistor
- 503 - Input temp. sensor (Expansion valve)
- 504 - Inlet heat exchanger temp. thermistor (refrigerant heat exchanger)
- 505 - Middle heat exchanger temp. thermistor

- (refrigerant heat exchanger)
- 506 - Output temp. sensor (Air to Refrigerant Heat Exchanger)
- 507 - Flow temp. Thermistor (hydraulic heat exchanger)
- 520 - Return temp. sensor (heating circuit)
- 521 - Flow temp. sensor (heating circuit)

■ 1 heating circuit with DHW

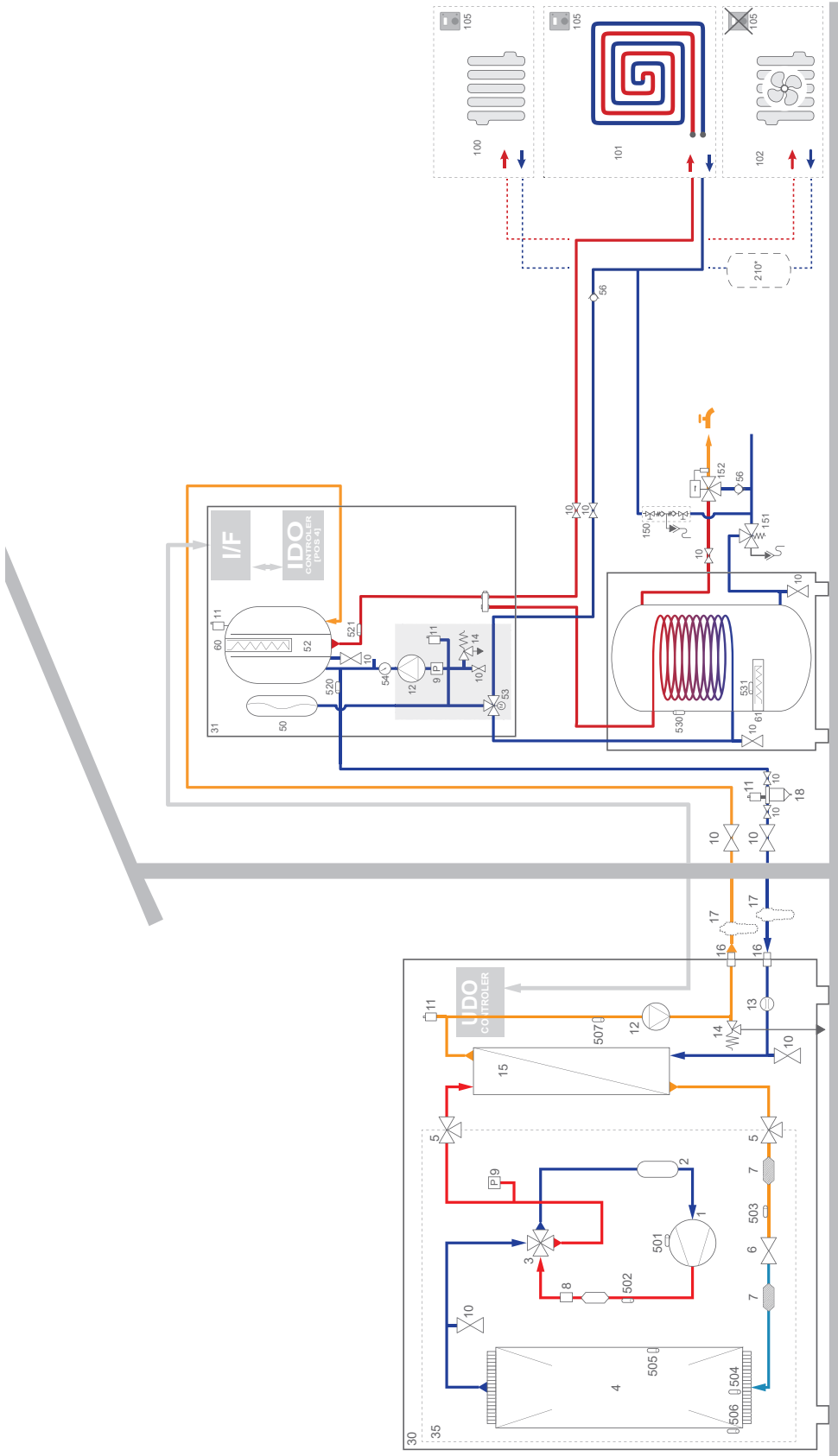

- 1 - Compressor
- 2 - Accumulator
- 3 - 4-way valve
- 4 - Heat exchanger (Evaporator)
- 5 - 3-way valve
- 6 - Expansion valve
- 7 - Filter
- 8 - Pressure switch (On/Off)
- 9 - Pressure sensor (Value)
- 10 - Valve
- 11 - Bleeder valve
- 12 - Circulating pump
- 13 - Flowmeter
- 14 - Pressure relief valve (PRV)
- 15 - Refrigerant to Water Heat Exchanger
- 16 - Connection
- 17 - Antifreeze valve
- 18 - Sediment trap
- 30 - Outdoor unit
- 31 - Hydraulic unit 1 service
- 50 - Expansion vessel
- 52 - Decoupling bottle
- 53 - Directional valve
- 54 - Manometer
- 56 - Non return valve
- 60 - HP Electrical backup
- 61 - DHW Electrical backup
- 100 - Radiator
- 101 - Heating floor
- 102 - Dynamic radiator (fan-convector)
- 105 - Room thermostat
- 210 - Buffer tank
- 501 - Compressor temp. sensor
- 502 - Discharge temp. thermistor
- 503 - Input temp. sensor (Expansion valve)
- 504 - Inlet heat exchanger temp. thermistor
- (refrigerant heat exchanger)
- 505 - Middle heat exchanger temp. thermistor (refrigerant heat exchanger)
- 506 - Output temp. sensor (Air to Refrigerant Heat Exchanger)
- 507 - Flow temp. Thermistor (hydraulic heat exchanger)
- 520 - Return temp. sensor (heating circuit)
- 521 - Flow temp. sensor (heating circuit)
- 530 - DHW temp. sensor
- 531 - DHW electrical backup thermal safety

■ 2 heating circuits

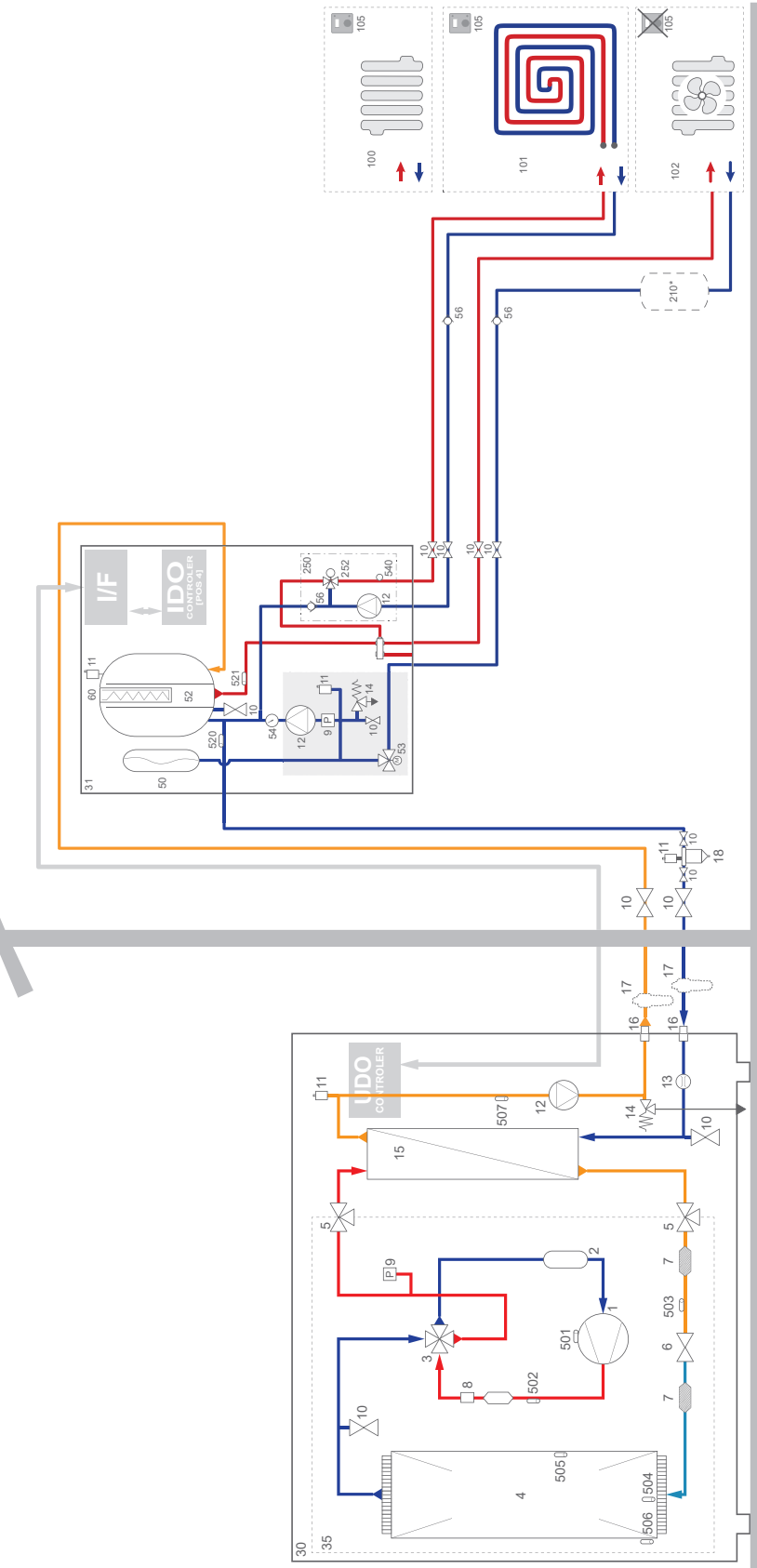

- | | | | |
|---------------------------------|--|--|---|
| 1 - Compressor | 13 - Flowmeter | 56 - Non return valve | 503 - Input temp. sensor (Expansion valve) |
| 2 - Accumulator | 14 - Pressure relief valve (PRV) | 60 - HP Electrical backup | 504 - Inlet heat exchanger temp. thermistor (refrigerant heat exchanger) |
| 3 - 4-way valve | 15 - Refrigerant to Water Heat Exchanger | 100 - Radiator | 505 - Middle heat exchanger temp. thermistor (refrigerant heat exchanger) |
| 4 - Heat exchanger (Evaporator) | 16 - Connection | 101 - Heating floor | 506 - Output temp. sensor (Air to Refrigerant Heat Exchanger) |
| 5 - 3-way valve | 17 - Antifreeze valve | 102 - Dynamic radiator (fan-convector) | 507 - Flow temp. Thermistor (hydraulic heat exchanger) |
| 6 - Expansion valve | 18 - Sediment trap | 105 - Room thermostat | 520 - Return temp. sensor (heating circuit) |
| 7 - Filter | 30 - Outdoor unit | 200 - Direct heating circuit kit | 521 - Flow temp. sensor (heating circuit) |
| 8 - Pressure switch (On/Off) | 31 - Hydraulic unit 1 service | 210 - Buffer tank | 540 - Flow temp. sensor (Mixed heating circuit) |
| 9 - Pressure sensor (Value) | 50 - Expansion vessel | 250 - 2 circuits kit | |
| 10 - Valve | 52 - Decoupling bottle | 252 - Mixing valve | |
| 11 - Bleeder valve | 53 - Directional valve | 501 - Compressor temp. sensor | |
| 12 - Circulating pump | 54 - Manometer | 502 - Discharge temp. thermistor | |

Electrical cabling plan

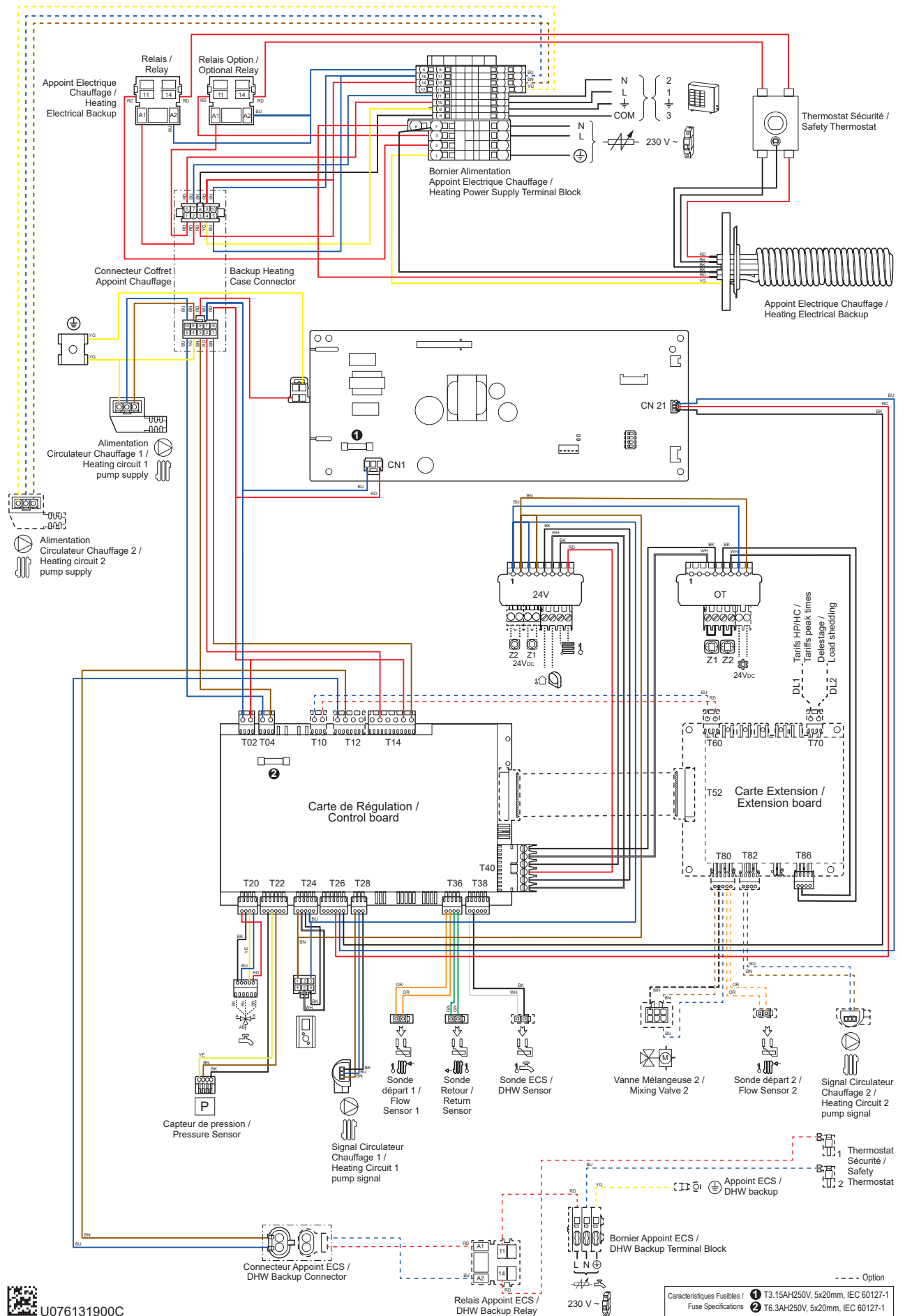

fig. 17 - Electrical wiring Hydraulic module (excluding installer connections)

✓ Start-up procedure

Before powering up the hydraulic module:

- Check the electric wiring.
- Check the hydraulic circuit pressure (1 to 2 bars), and ensure that the heat pump and the rest of the installation has been bled.

► Start-up check-list

▼ Before starting-up

	OK	Not compliant
Outdoor unit visual checks (see outdoor unit installation manual).		
Position and attachments, condensate evacuation.		
Compliance with distances from obstacles.		
Hydraulic unit hydronic checks (see section "Installing the hydraulic unit", page 11).		
Connections of pipes, filter valve, flaps and pumps (heating circuit, DHW).		
Installation water volume (expansion tank capacity adapted ?).		
No leaks.		
Primary and gas release network pressure.		
Outdoor unit electrical checks (see outdoor unit installation manual).		
Main power supply (230 V).		
Protection by rated circuit breaker.		
Cable section.		
Earth connection.		
Power supply and protection.		
Hydraulic unit electrical checks (see section "Electrical connections", page 14).		
Power supply (230 V).		
Connection to outdoor unit.		
Sensors connection (positioning and connections).		
Distribution valve connections (boiler and DHW) and circulation pump.		
Power supply and protection for electric backup.		

▼ Starting-up

	OK	Not compliant
Quick start Procedure (see chapter "Commissioning", page 23 and § "Controller menu", page 25).		
Switch on the system's main circuit breaker (outdoor unit power supply) 6 hours before testing => Preheat compressor.		
Initialize for a few seconds => Easy Start.		
Heating circulator operation.		
Outdoor unit starts after 4 minutes.		
Configure time, date and CC time programs, if different from default values.		
Configure hydraulic circuit.		
Adjust max. flow setpoint.		
Outdoor unit checks		
Operation of fan(s), compressor.		
Current measurement.		
After several minutes measure the difference in air temperature.		
Check condensation and evaporation pressure/temperature.		
Hydraulic unit checks		
After 15 minutes of operation.		
Delta T° primary water.		
Operation of heating, boiler backup, etc.		
Room control (see chapter "Commissioning", page 23)		
Settings, maintenance, checks.		
Program the heating periods.		
Adjust the setpoints for the heating circuits if different from the default values.		
Setpoint display.		
Explications d'utilisation		



The heat pump is ready for operation!

► Commissioning data sheet

Installation site				Installer								
Outdoor unit	Serial n°			Hydraulique unit	Serial n°							
	Model				Model							
Refrigerant type						Refrigerant charge						
								kg				
Controls				Outdoor unit operating voltages and currents								
Compliance with installation distances				L/N				V				
Correct condensates drainage								L/T				V
Electrical connections/tightening of connections												Icomp
Hydraulic network on Hydraulic module												
Secondary network	Underfloor heating		}	Circulator		Type						
	LV radiators											
	Fan-convector											
Domestic hot water; storage tank type												
Estimated secondary network water volume		L										
Options & accessories												
Auxiliary power supply				Room thermostat								
DHW supply				Radio room thermostat								
Correct outdoor sensor location												
Correct room thermostat location												
2-circuits kit				Details								
Control setting												
Configuration type												
Essential settings												

Instruction for the end user

Explain the operation of the system to the user, in particular the functions of the room sensor and the programs available on the user interface.



Emphasize that underfloor heating systems have a high inertia, so settings must be made gradually. Also explain how to control the filling of the heating circuit.

End-of-life of the appliance



The dismantling and recycling of devices must be carried out by a specialized service. Under no circumstances should devices be disposed of with household waste, bulky items or landfill.

At the end of the device's life, please contact your installer or local representative to arrange for dismantling and recycling.



Keymark Certification:

- 012-C700311 - Fujitsu Airstage Monobloc Comfort WH 5
- 012-C700312 - Fujitsu Airstage Monobloc Comfort WH 8
- 012-C700313 - Fujitsu Airstage Monobloc Comfort WH 10



are in conformity with the relevant Union harmonized directives and regulations:

- Low Voltage Directive (LVD) - 2014/35/EU
- Machinery Regulation - (EU) 2023/1230
- ElectroMagnetic Compliance (EMC) Directive - 2014/30/EU
- Commission Regulation / Directives - (EU) 811/2013
- Energy labelling ; Ecodesign - (EU) 2017/1369 - 2009/125/EC
- RoHS Directive - 2011/65/EU - (EU) 2015/863

Wi-Fi® is a trademark or registered trademark of Wi-Fi Alliance.

Commissioning date:

Address of your heating installer or customer service.

FUJITSU

Fujitsu General (Euro) GmbH
Fritz-Vomfelde-Strasse 26-32
40547 Düsseldorf - Germany