

OPERATING AND COMMISSIONING INSTRUCTIONS

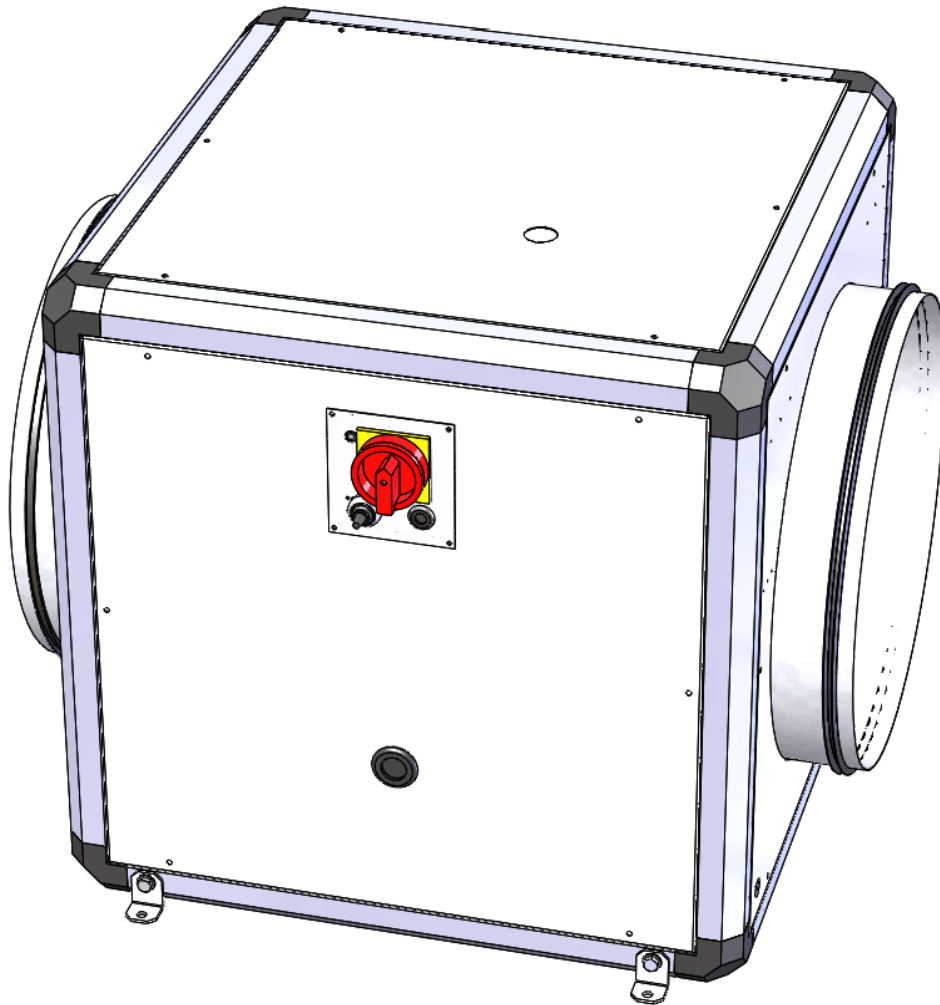

OPERATING AND COMMISSIONING INSTRUCTIONS

Table des matières

I. RECEIVING THE EQUIPMENT	3
I.1. Checks on reception.....	3
I.2. Unpacking.....	3
I.3. Storing.....	3
II. INSTALLATION	4
II.1. Handling.....	4
II.2. Space required.....	4
II.3. Installation.....	4
III. GENERAL FONCTIONNING	5
III.1. VERSION STANDARD.....	5
III.1. VERSION LOBBY.....	5
III.1. VERSION DIVA.....	5
III.1. VERSION MAC2.....	5
IV. ELECTRICAL WIRING	5
IV.1. MVBL EC STANDARD.....	5
IV.2. MVBL EC LOBBY.....	6
IV.3. MVBL EC DIVA.....	6
IV.4. MVBL EC MAC2.....	7
V. MVBL EC LOBBY SETTINGS	7
V.1.a. Controller presentation.....	7
V.1.b. Tree view of menu and settings.....	8
VI. MVBL EC DIVA SETTINGS	9
VII. MVBL EC MAC2 SETTINGS	9
VII.1. Display control (on Corrigo or remote display).....	9
VII.1. Operator parameters modification (password 3333 required).....	12
VII.1.a. Réglage des différentes horloges dates et heures.....	12
VII.1.b. Air flows modification.....	12
VII.1.a. Forced stop of the unit or forced start LS or HS on the remote control.....	12
VII.2. Paramétrages système (communication).....	13
VII.2.a. Arborescence des menus niveau system.....	13
VII.2.b. Modification des paramètres système.....	13
VIII. MAINTENANCE	15
VIII.1. Battery replacement (MVBL EC MAC2 only).....	15
IX. REPAIR	16
IX.1. MVBL EC STANDARD.....	16
IX.2. MVBL EC LOBBY.....	16
IX.3. MVBL EC DIVA.....	16
IX.4. MVBL EC MAC2.....	16
X. MODBUS	17

OPERATING AND COMMISSIONING INSTRUCTIONS

X.1. MVBL EC LOBBY	17
X.2. MVBL EC MAC2.....	18
XI. NOTES.....	19

SAFETY INSTRUCTIONS

In compliance with the current norms, the machine should be installed only by a technical person qualified for this type of work.

Use the required personal protection devices so as to avoid injuries caused by electrical and mechanical hazards (injuries by touching panels, sharp edges, etc.). Use EN170 protective eyewear and ear protection.

Do not use the unit for an other used which it designed. This unit can't be use for extract or supply dangerous air.

Move the machine as given in chapter *handling*.

Grounding is carried out in compliance with current standards. Never start the device without grounding

Before any intervention ensure that device is powered off and wait for complete stop of every rotative component such as damper, fan, rotative exchanger...

During device is running inspection doors must be mounted and closed.

Start is to be done only with padlockable swith.

Do not shut off or short circuit the safety and control equipment.

During interventions, be carefull with hot components such as hot water coil or electric resistances.

The machine should be installed in compliance with fire norms and regulation in each country.

The waste must be disposed of in compliance with the current standards. No packaging should be discarded into the environment.

We disclaim any responsibility for any damages resulting from wrong utilisation of the equipment, reparation, modification or non compliance of these instructions.

I. RECEIVING THE EQUIPMENT

The units are delivered fixed on longitudinal members or on blocks then wrapped in plastic film..

I.1. Checks on reception

When the equipment is received, the state of the packaging and the equipment must be checked. In the event of damage, make an accurate note of any problems on the carrier's delivery note

I.2. Unpacking

When the equipment is unpacked, check the following:

- The total number of packages is present.
- All accessories are present (dampers, roof, electric switchgear, etc.). After unpacking the equipment, the waste must be disposed of in compliance with the current standards. No packaging should be discarded into the environment

I.3. Storing

The equipment must be stored in shade, in a dry place, at a temperature between -20°C and 40°C. The packaging can't be considered sufficient for an external storage.

OPERATING AND COMMISSIONING INSTRUCTIONS

II. INSTALLATION

II.1. Handling

The units must only be moved in their installation position.

If the device is handled using a fork-lift truck, ensure this supports the load-bearing structure

If the device is moved using a crane, use four cables of identical lengths. These must be at least as long as the greatest distance between two fastening points.

If $L + W + H > 5m$ then the case must be lifted using a lifting beam

II.2. Space required

Generally speaking, it is desirable to provide access space of at least the width of the unit on the each side for maintenance.

Modèle MVBL EC	Taille module COMBIBOX®	A mm	B mm	C mm	∅ mm	Poids kg
MVBL EC 4	4	445	445	445	315	37
MVBL EC 5	5	545	545	545	400	52
MVBL EC 6	6	645	645	645	450	72
MVBL EC 7	7	745	745	745	500	95
MVBL EC 8	8	845	845	970	630	129
MVBL EC 9	9	945	945	1170	800	166

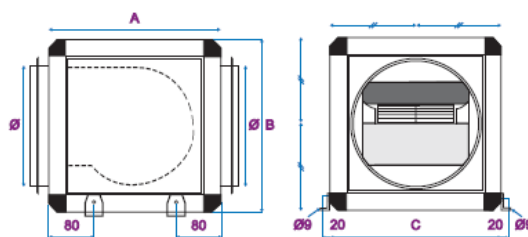

II.3. Installation

The unit must be laid on a sufficiently rigid and flat surface (use vibration mounts if necessary).

Install the unit such that bad weather or ambient temperature cannot damage the internal items of the unit during installation as well as when used later (possibly provide a protective cap).

If inlet or outlet of the fan are not connected, you have to install a protection grid

Outdoor installation of the unit: For raising the unit above the ground (protection from water), a set of feet may optionally be supplied (PCB). A roof (TCB) as well as grated bevelled nozzles (BBG) or rain cowls (AGC) must also be provided if necessary (available as options).

Installation of the units in ceiling : units can be suspended with threaded rods. They can also be laid on a frame, suspended on the building structure, within the load capacity of the frame (frame in charge of the installer).

HVAC connections :

For the HVAC connection, select duct sections based on dimensions of the flexible bands that should be properly stretched. The ducts have to be insulated if necessary.

OPERATING AND COMMISSIONING INSTRUCTIONS

III. GENERAL FONCTIONNING

Equipped in standard with control and proximity switch, this extract or supply box fan is composed by high efficiency EC motor with included thermal protection. Fan with forward curve blades for size 4 to 7 and backward curve blades for size 8 and 9.

III.1.VERSION STANDARD

fan is adjustable from integrated potentiometer. Add a pressure switch to know if the fan is running or not

III.1.VERSION LOBBY

MVBL EC LOBBY (constant pressure) is equipped with a pressure transmitter and a controller. You have the possibility to set the pressure. A fan default is managed by the pressure transmitter. Modbus RS485 communication available

III.1.VERSION DIVA

MVBL EC DIVA (proportionnal ventilation between two airflows with CO2 management) is equipped with a CO2 controller. You have the possibility to set min/max airflows and CO2 setpoint
Add a pressure switch to know if the fan is running or not.

III.1.VERSION MAC2

MVBL EC MAC2 (1 or 2 constant air flow (m³/h) adjustable) is equipped with a pressure transmitter and a controller. You have the possibility to set 2 airflows. A fan default is managed by the pressure transmitter. Modbus RS485 communication available

IV. ELECTRICAL WIRING

MVBL EC EC	Size COMBIBOX®	Supply voltage (V / Ph / Hz)	Nominal power(W)	Amps (A)	Used temp (°C/°C)	Motor IP/Class	Thermal protection*
MVBL EC 4	4	230 / 1 / 50	1070	4,3	-25 / 40	IP44 / F	PTI
MVBL EC 5	5	230 / 1 / 50	1040	4,5	-25 / 40	IP44 / F	PTI
MVBL EC 6	6	230 / 1 / 50	1030	4,4	-20 / 40	IP44 / F	PTI
MVBL EC 7	7	230 / 1 / 50	1790	7,5	-20 / 40	IP44 / F	PTI
MVBL EC 8	8	230 / 1 / 50	2310	10	-20 / 40	IP44 / F	PTI
MVBL EC 9	9	230 / 1 / 50	2110	8,8	-20 / 40	IP44 / F	PTI

* PTI : Protection thermique intégrée

IV.1. MVBL EC STANDARD

External 0-10V wiring : You have the possibility to connect an external 0-10V : Disconnect the white and green wires on the potentiometer (white = 0V / green = 0-10V)

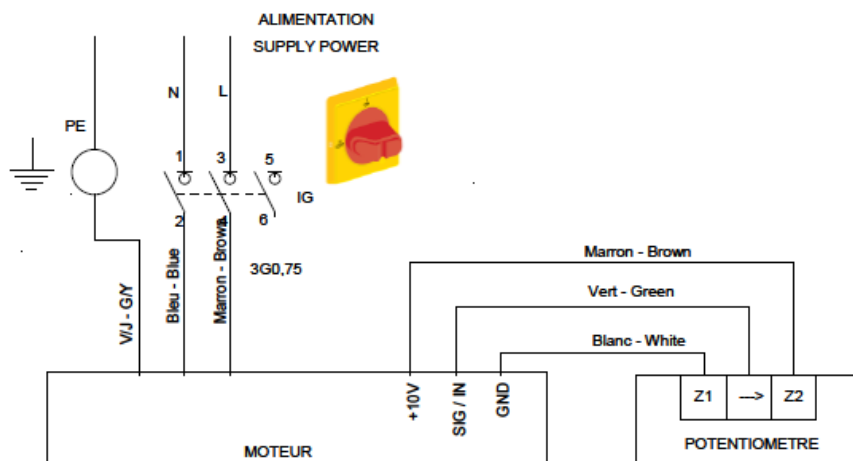

OPERATING AND COMMISSIONING INSTRUCTIONS

IV.2. MVBL EC LOBBY

Pressure tube connection :

- Extract (mounted in standard) : The - is connected on the box fan and the + is not connected
- Supply : The + have to be connected on the supply duct and the - is not connected

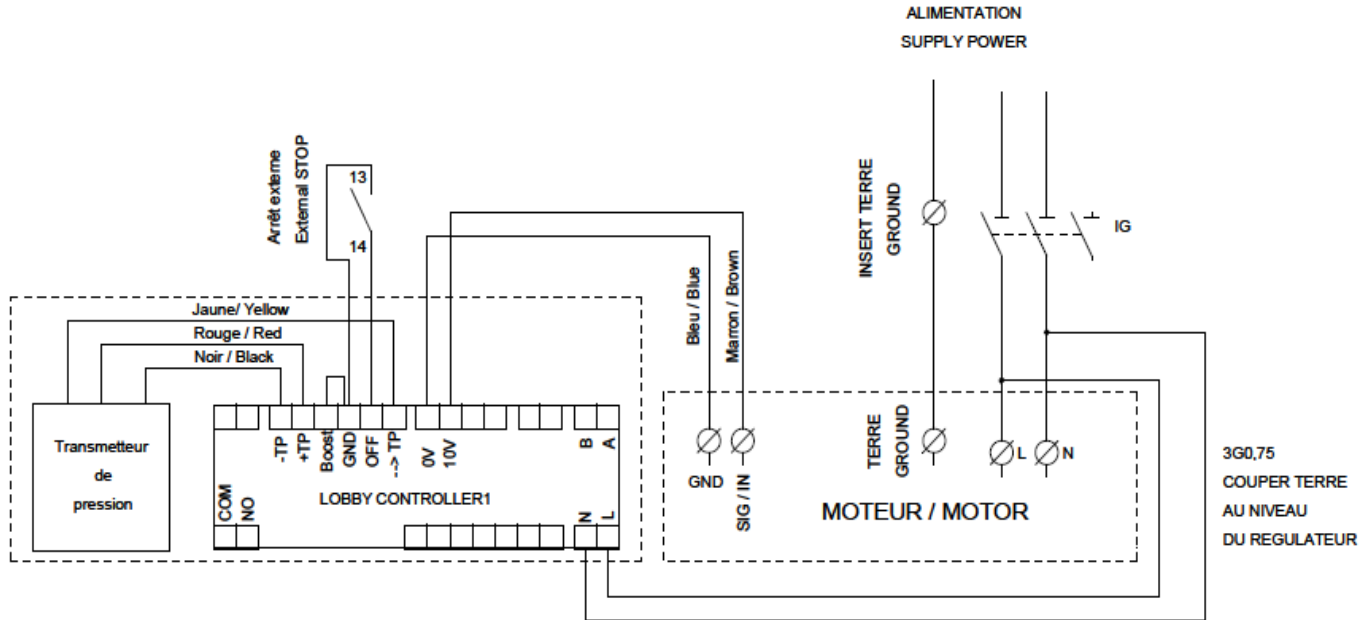

Ce document est notre propriété, il ne peut être reproduit sans notre accord écrit

IV.3. MVBL EC DIVA

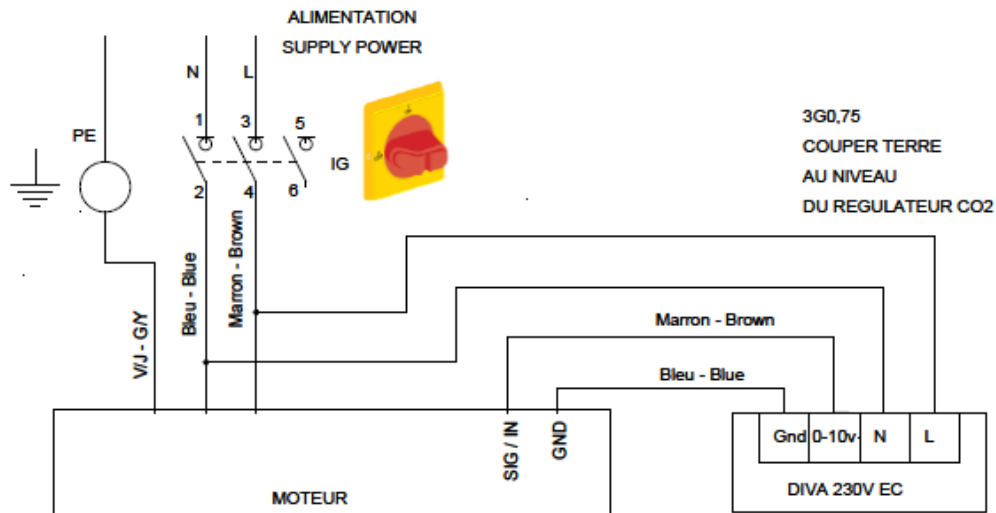

OPERATING AND COMMISSIONING INSTRUCTIONS

IV.4. MVBL EC MAC2

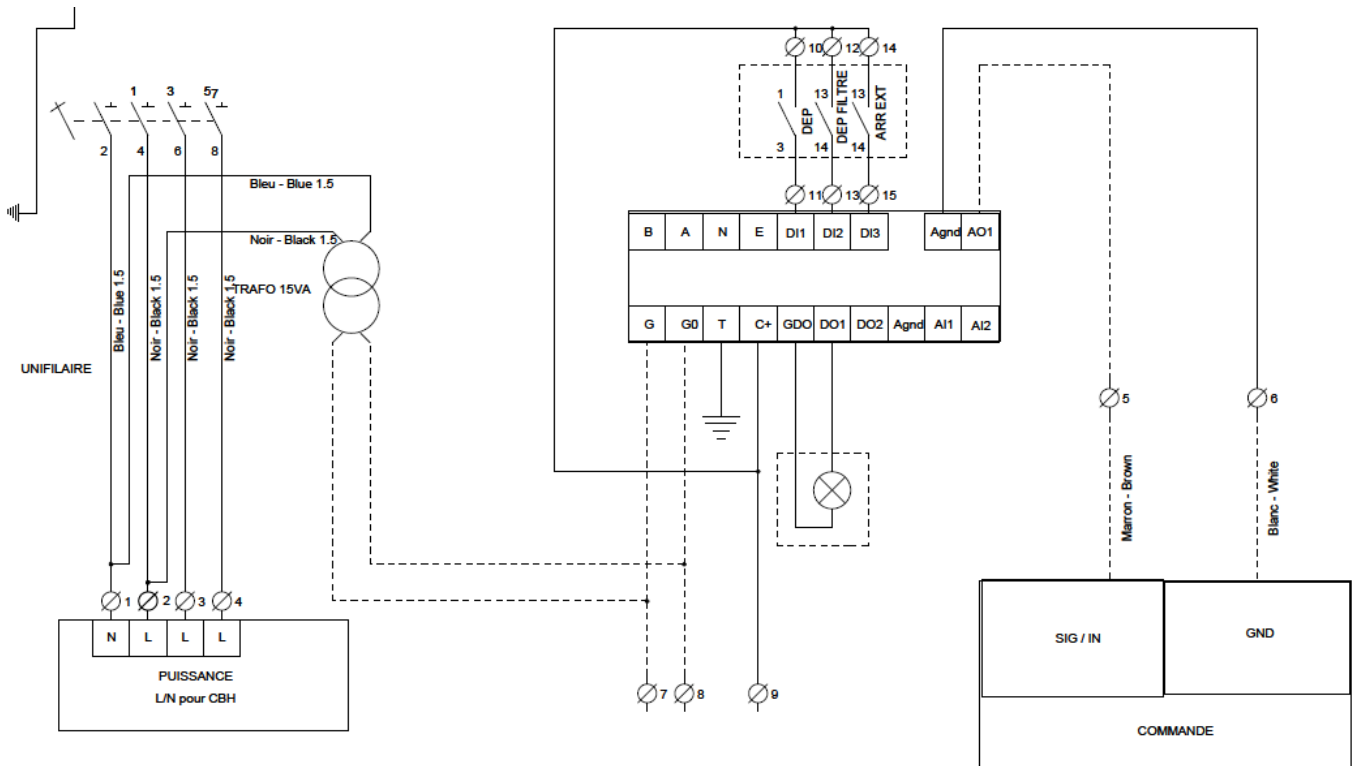





Ce document est notre propriété. Il ne peut être reproduit qu'avec notre accord écrit

V. MVBL EC LOBBY SETTINGS

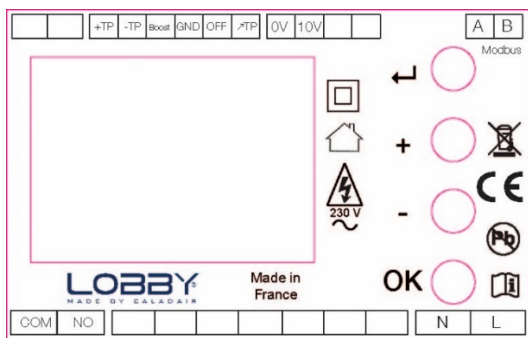
V.1.a. Controller presentation

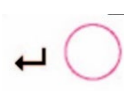
The setting be done entirely on the controller positionned on the fan Box

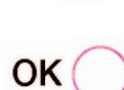

-  Home screen return
-  Change value
-  Validate the value
-  Access to pressure setpoint
-  Access to service menu by long press

OPERATING AND COMMISSIONING INSTRUCTIONS

V.1.b. *Tree view of menu and settings*

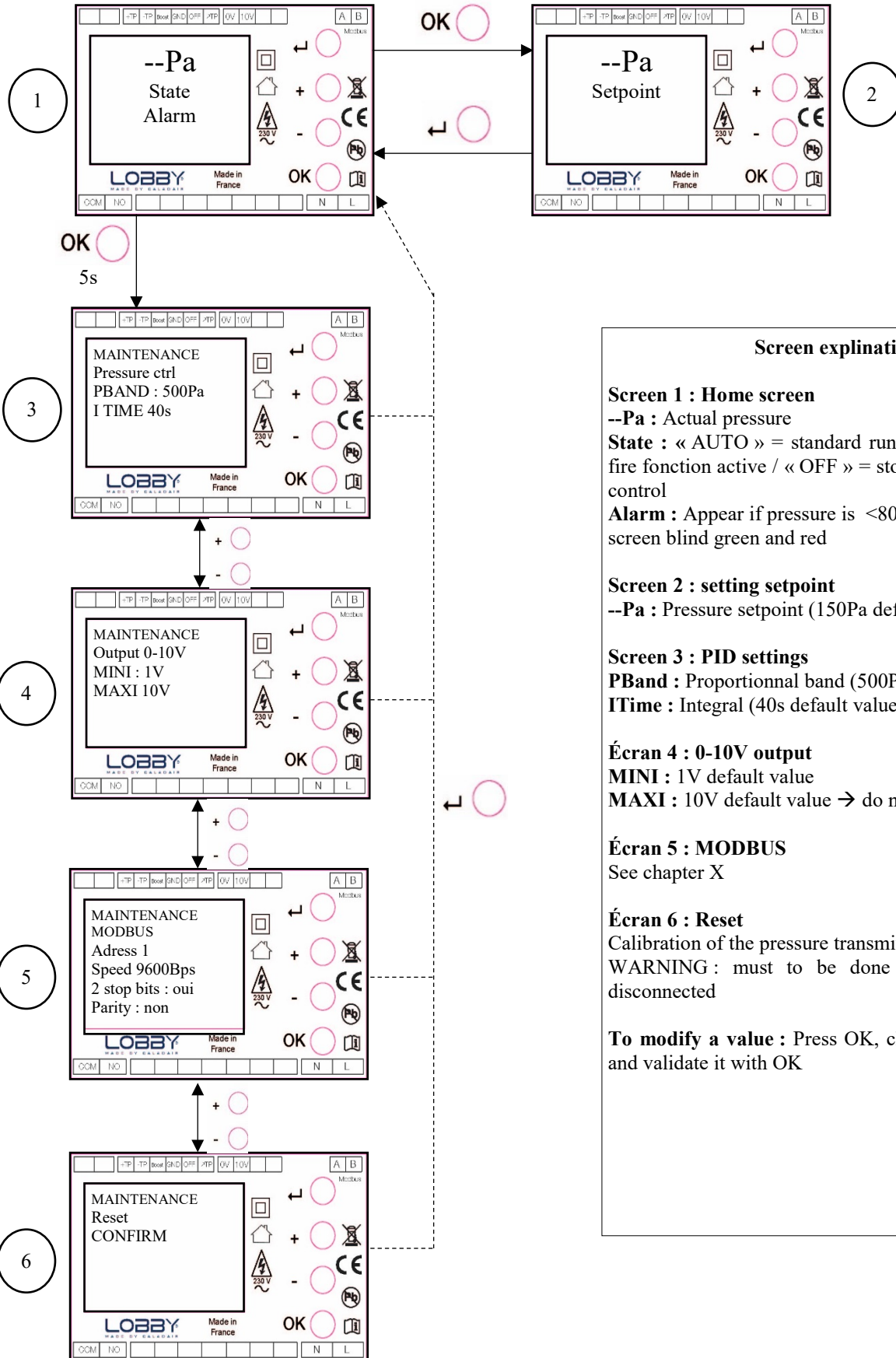

Screen explanations

Screen 1 : Home screen

--Pa : Actual pressure

State : « AUTO » = standard running / « BOOST » = fire function active / « OFF » = stop by external remote control

Alarm : Appear if pressure is <80Pa. In this case, the screen blind green and red

Screen 2 : setting setpoint

--Pa : Pressure setpoint (150Pa default value)

Screen 3 : PID settings

PBAnd : Proportionnal band (500Pa default value)

ITime : Integral (40s default value)

Écran 4 : 0-10V output

MINI : 1V default value

MAXI : 10V default value → do not modified

Écran 5 : MODBUS

See chapter X

Écran 6 : Reset

Calibration of the pressure transmitter.

WARNING : must to be done with pressure tube disconnected

To modify a value : Press OK, change value with +/- and validate it with OK

OPERATING AND COMMISSIONING INSTRUCTIONS

VI. MVBL EC DIVA SETTINGS

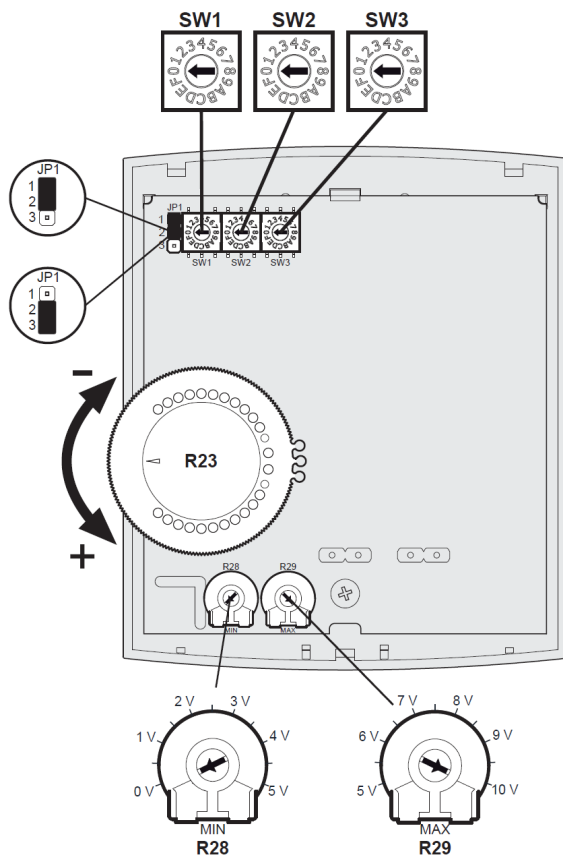

Factory settings :

SW1 = Not used

SW2 = PBAND CO2 = 9 → Do not modify

SW3 = CO2 setpoint = D

SW3	0*	1	2	3	4	5	6	7
Consigne (ppm)	350	400	450	500	550	600	650	700

SW3	8	9	A	B	C	D	E	F
Consigne (ppm)	750	800	850	900	950	1 000	1 200	1 500

JP1 = Heating mode = switch between 1-2 → Do not modify

R23 = temperature setpoint = Turn at maximum in clockwise (blue max) → Do not modify

R28 = Minimum ventilation = 25%

R29 = Maximum ventilation = 75%

VII. MVBL EC MAC2 SETTINGS

VII.1. Display control (on Corrigo or remote display)

There are four lines of twenty characters on the backlight display. The light only starts when a button is pushed. It stops after an inactivity period.

There are 2 LED on the front of the display:

LED of the alarm is a bell symbol.

LED for the writing with a pen symbol.

- Quick blinking = you can modify the value

- Slow blinking = you must enter a password to modify the value

- Directional arrows up, down left and right help to navigate in the menus.
- Up and Down buttons help to increase or decrease the values of a parameter when you have access to. Right and left buttons help to navigate inside the parameter.
- OK button help to enter the value and to confirm a choice. C button helps to cancel it.
- Alarm button (red) allows the access of the defaults list.
- Left arrow also helps to go out of the alarm menu and go back to the main menu
- Cursors indicate the possible movements and which arrows to press.

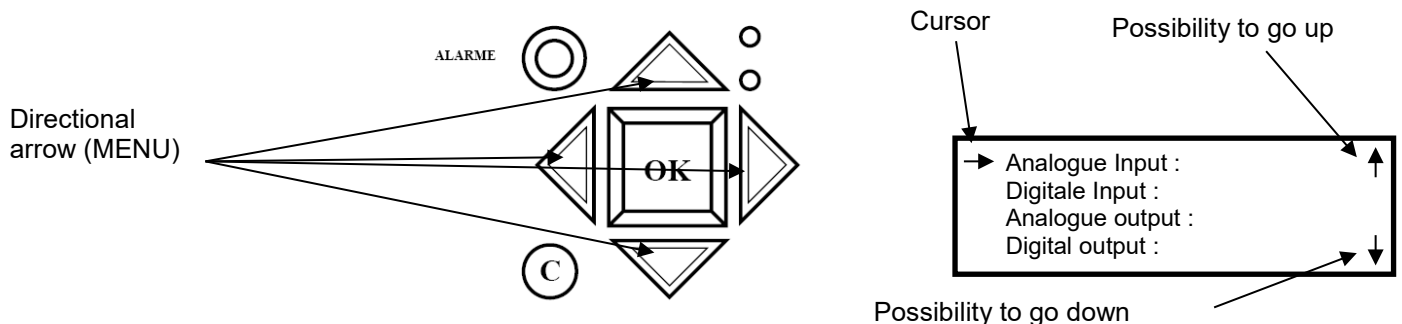

OPERATING AND COMMISSIONING INSTRUCTIONS

Words in normal writing = viewing only / **Words in bold** = Modification is possible / **Outlined words in bold** = Modification is possible with password 3333 ... = non accessible or not used



WARNING : Do not modify parameters which are not in bold characters, in this case no after sales will be admitted

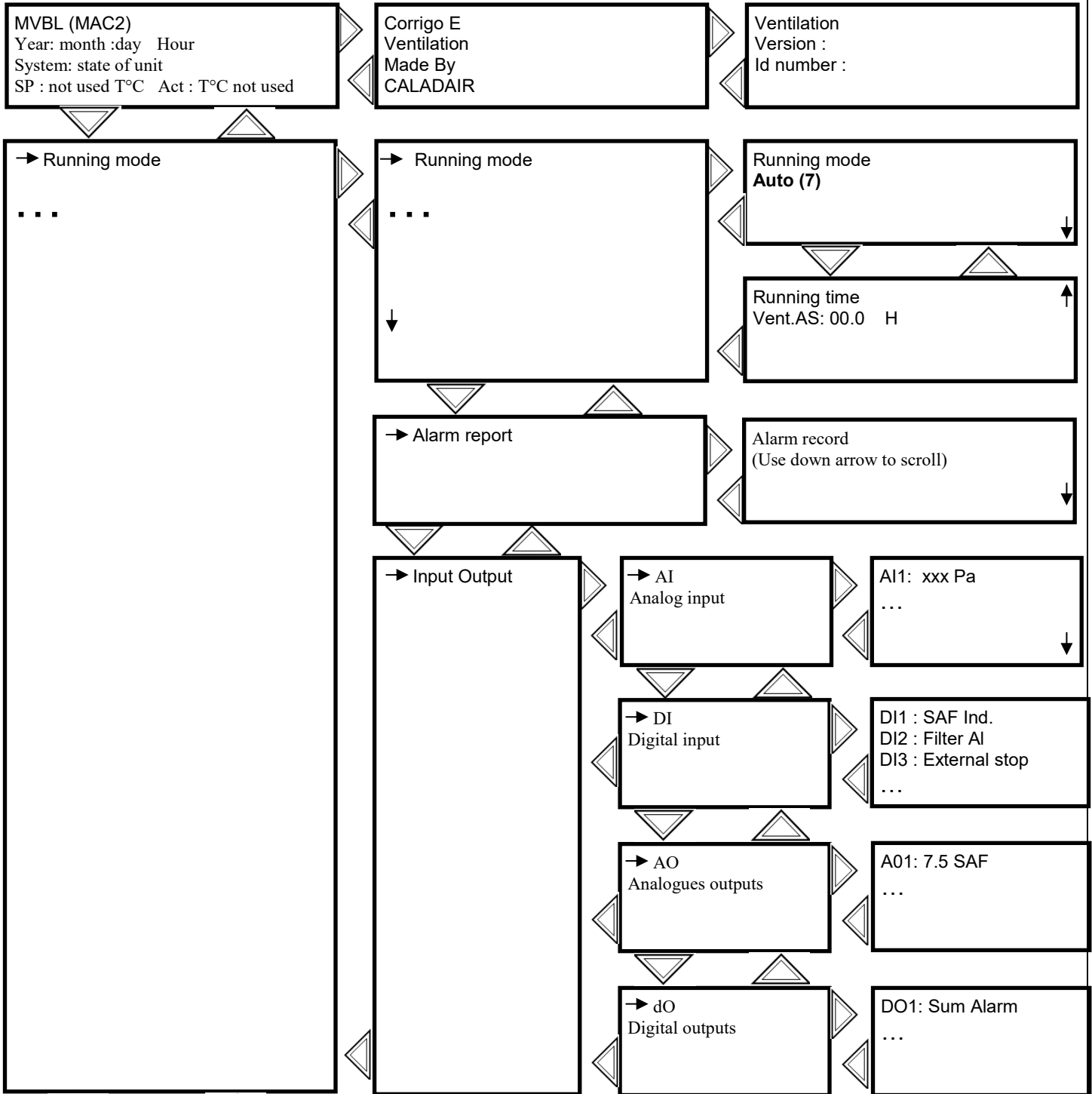

(6) **Manual / auto mode (see page 12)**

OPERATING AND COMMISSIONING INSTRUCTIONS

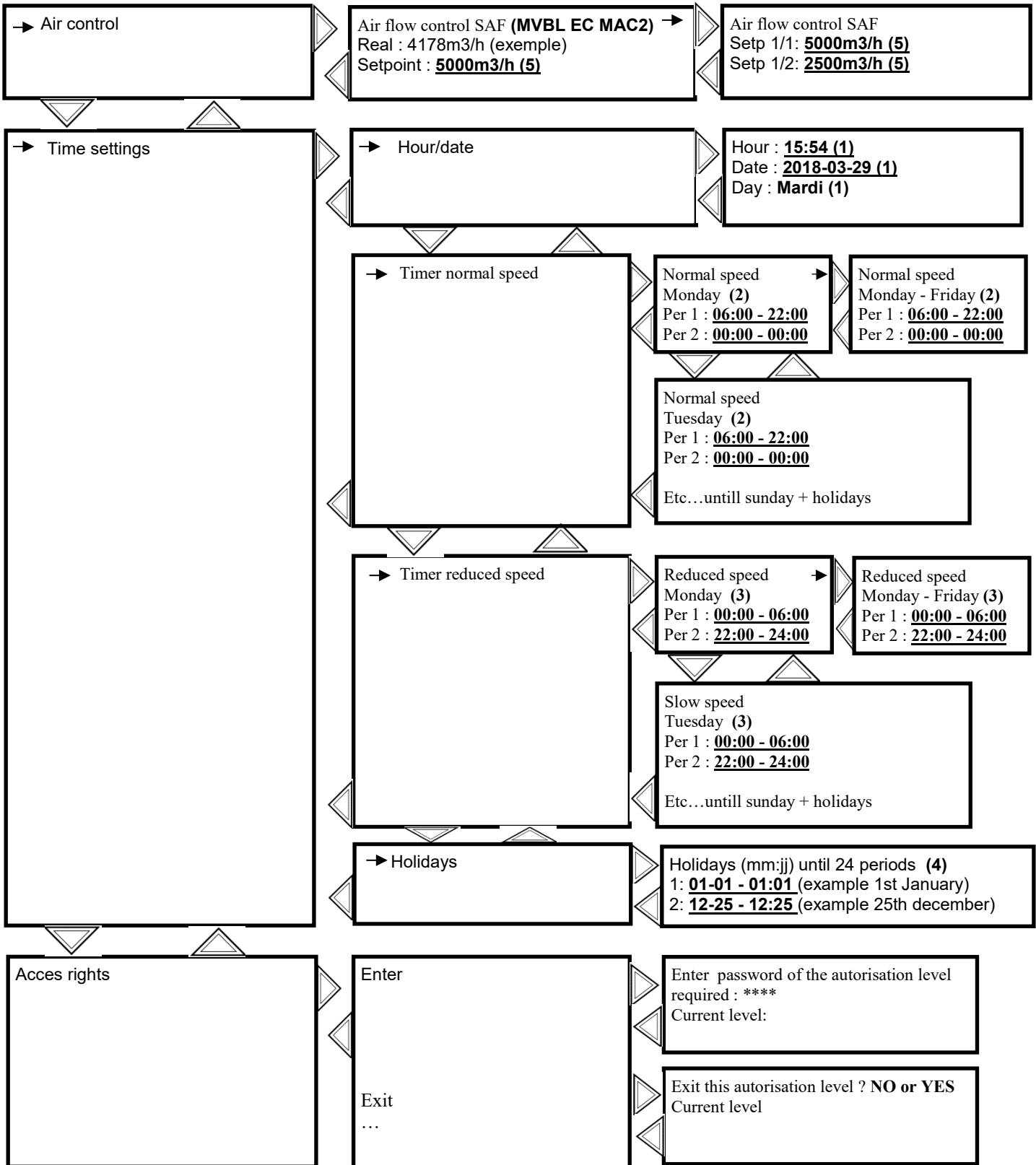

- (1) Hour date sttings (see page 12)
- (2) Timer normal speed settings (see page 12)
- (3) Timer reduced speed settings (see page 12)
- (4) Holidays settings (see page 12)
- (5) Air flow settings (see page 12)

OPERATING AND COMMISSIONING INSTRUCTIONS

VII.1. Operator parameters modification (password 3333 required)

VII.1.a. Réglage des différentes horloges dates et heures

VII.1.a.1. *Hour and date of the controller CORRIGO (1) page 11*

Access : Hour Date setting

Date and hour of the regulator are set by default in the CORRIGO controller. Summer/Winter time is automatically managed.

VII.1.a.2. *Timer normal and reduced speed (2) (3) page 11*

Access :

- **Timer normal speed** : Time settings / normal speed programm
- **Timer reduced speed** : Time settings / slow speed programm

Nota : if slow speed (LS-1/2) and normal speed (HS-1/1) are activated in the same time window, unit works in high speed
Operation exceptions:

VII.1.a.3. *Holidays time (4) page 11*

Access : Hour settings / holidays

System is set with no vacation time. If you need to reduce fonctionnement time during vacation time, set the functioning time window as indicated in chapter V.3.4), and set the vacation days.

VII.1.b. Air flows modification

Access : ventilation Regul / Airflow control VAS 1/1 and 1/2

You can modify the rotation speed of the unit in PV-1/2 (slow speed) and in HS-1/1 (normal speed) to set the airflows.
Be careful not to settle below the values noted below

MVBL EC4	800 m3/h
MVBL EC5	1000 m3/h
MVBL EC6	1500 m3/h
MVBL EC7	1800 m3/h

VII.1.a. Forced stop of the unit or forced start LS or HS on the remote control

Access : running Mode / running Mode

You can stop (7) (**stop**) unit with CORRIGO controller or do a forced start LS (7) (**manual speed 1/2**) or HS (7) (**manual speed 1/1**). In standard unit works automatically with clocks (7) (**Auto**)



If unit do not work in automatic mode an alarm will start. Manual speed 1/1 and manual speed 1/2 modes must be used only for the commissioning and repair. An other setting will lead to a failure of the unit.

OPERATING AND COMMISSIONING INSTRUCTIONS

VII.2. Paramétrages système (communication)

VII.2.a. Arborescence des menus niveau system

Words in normal writing = viewing only / **Words in bold** = Modification is possible / **Outlined words in bold** = Modification is possible with password 1111 ... = non accessible or not used



WARNING : Do not modify parameters which are not in bold characters, in this case no after sales will be admitted

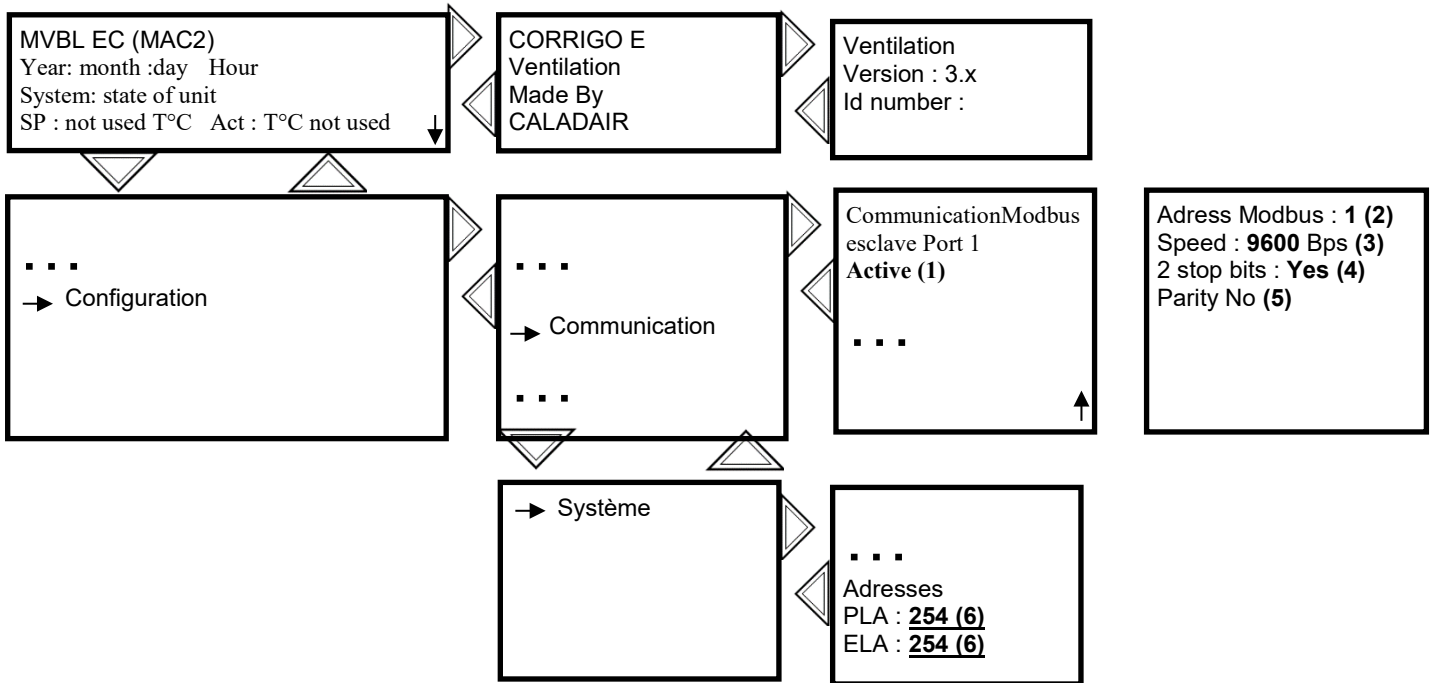

- (1) Activation MODBUS (see page 14)
- (2) (3) (4) (5) Paramètres MODBUS (voir page 14)
- (6) Paramètre Répétiteur / EXO (voir page 14)

VII.2.b. Modification des paramètres système

VII.2.b.1. Accès au niveau system (passwor 1111)

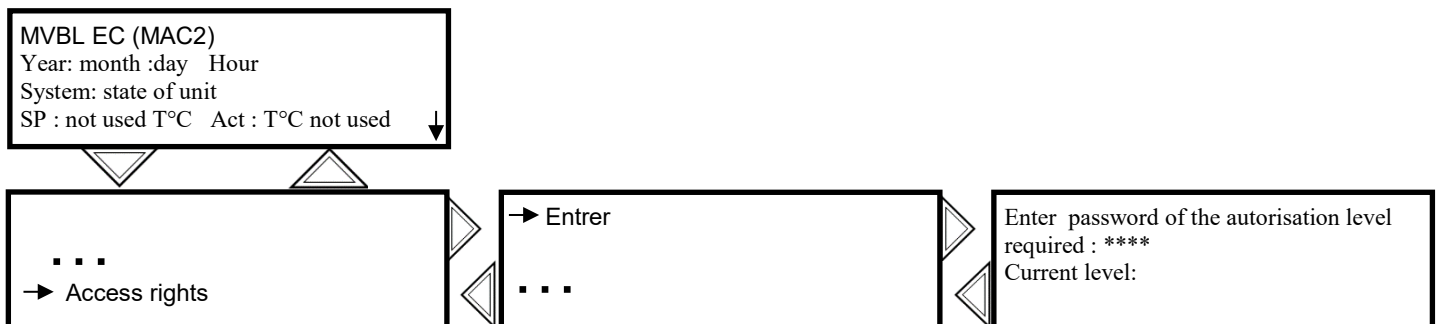

OPERATING AND COMMISSIONING INSTRUCTIONS

VII.2.b.2. Répétitors (password 1111 required)

Access : Configuration / System

An instruction and commissioning manual is delivered with repetitor. In the case of you have several CORRIGO connected to the same remote control (up to 6 CORRIGO), you have to modify the address PLA / ELA of each CORRIGO. In this case you will need a different address on each CORRIGO and enter them in the repetitor. Follow the instructions in the commissioning manual for the setting and use.

VII.2.b.3. MODBUS via RS485 (password 1111 required)

You will find the simplified MODBUS at the end of the instructions and commissioning manual.

Access : Configuration / Communication

Le **MODBUS RS 485** must be activate. Possibility to set speed, parity, stop bits...

Modbus Type

1 = Coil status register (Modus fonction 1, 5 et 15)

2 = Input status register (Modus fonction 2)

3 = Holding register (Modus fonction 3, 6 et 16)

4 = Input resister (Modus fonction 4)

Supported Modbus functions

Read Coils (1)

Read discrete input (2)

Read Holding registers (3)

Read Input registers (4)

Write single Coils (5)

Write single register (6)

Write multiple Coils (15)

Write multiple register (16)

EXOL Type

R = Real (-3.3E38 – 3.3E38)

I = Integer (-32768 – 32767)

X = Index (0 – 255)

L = Logic (0/1)

Transmission mode

Controller is set in RTU mode

A maximum of 47 registers can be read in one message

OPERATING AND COMMISSIONING INSTRUCTIONS

VIII. MAINTENANCE

Outside the unit

Check the ducts, flexible sleeves, anti-vibrating plots; replace them if necessary. Check that all elements connected to the unit do not give any vibration to the unit.

Unit and Regulation

Check connection every year, clean fan if necessary

Fan

Dust the turbine and the volute if necessary.

Filtration

The filters are to be replaced every year or more if necessary

VIII.1. Battery replacement (MVBL EC MAC2 only)

When low battery alarm starts and red LED is lighting, this indicates that the safety battery for the safeguard of the memory and clock is too low. Follow the instructions below to change them. A condenser keeps the safeguard and let the clock running for 10 minutes left after power cut. If the replacement of the battery takes less than 10 minutes, you will not have to reset the program and clock will work normally.

Replacement battery is a CR2032 type



Press the clips on each sides of the box with a little screwdriver to open the the top of the box.

Location of the battery

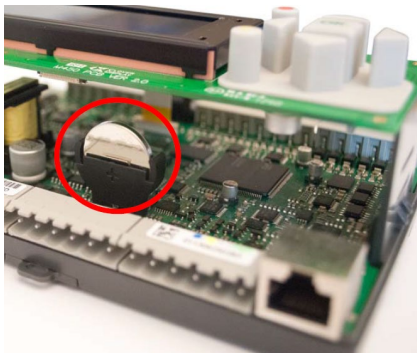

Take the battery and remove it softly .

Press firmly the new battery in the support. Note : Attention to the direction and polarity of the battery.

OPERATING AND COMMISSIONING INSTRUCTIONS

IX. REPAIR

For any other defect or anomaly found, and in case of inefficiency of troubleshooting, contact the After Sales Service. Defective parts must be replaced exclusively with original components (compliance with applicable product regulations)

IX.1. MVBL EC STANDARD

Description	Cause
Fan do not start	Unit is not powered correctly The motor is out of order Potentiometer or external 0-10V send 0V

IX.2. MVBL EC LOBBY

Nature du défaut	Cause(s) probable(s)
Fan do not start + nothing on display	Unit is not powered correctly The motor is out of order
The fans is not running	Wait 1 min because there is a temporisation at the starting up
Fan do not start + OFF displayed on screen	External remote stop is activated
« BOOST » displayed on scree	Restart the fan
« ALARME » and 0Pa are displayed on screen. Screen blind red/green	Pressure tube disconnected Wrong connection of pressure tube No pressure in duct

IX.3. MVBL EC DIVA

Nature du défaut	Cause(s) probable(s)
Fan do not start	Unit is not powered correctly The motor is out of order
Too much high or Too low air flow	Settings of CO2 controller

IX.4. MVBL EC MAC2

No alarm

Description	Cause
CORRIGO screen do not light up	- Unit is not powered correctly (LED P/B of CORRIGO switched off) - To light up the screen, press a button (backlit).
Fans do not start	- Clocks are on 0 - Active alarm

OPERATING AND COMMISSIONING INSTRUCTIONS

Alarm

View	Description	Type	Tempo	Cause
Malfunction supply air fan	Pressure must be higher than 5Pa if fan runs	A	120s	- Pressure is under 20Pa. - Motor thermal protection activate.
Filter guard 1		C	0s	-Filters are dirty -Control the connection of the crystal tubes
Manual	Runs in manual mode	C	0s	See chapter VII.1.c
Sensor error pressure VAS		A	5s	-0-10V signal is inverted -Pressure transmittor on fresh air is in short-circuit
Internal battery error	Error battery intern	A	5s	-Intern battery of the CORRIGO is disused -Change the battery quickly in order to not loose programm.

X. MODBUS

X.1. MVBL EC LOBBY

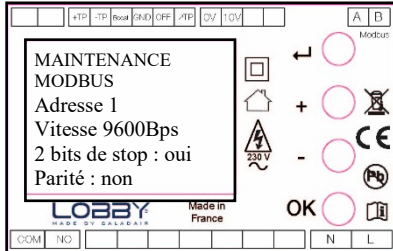

To access to these parameters, press OK button for 5s and follow the tree view explained chapter V.1

Possible settings :

- Adress (1-999) → Standard 1
- Speed (150-300-600-1200-2400-4800-9600-19200) → Standard 9600
- 2Bits de stops (OUI-NON) → Standard YES
- Parity (NON-IMPAIRE-PAIRE) → Standard NO

INPUT REGISTER

adresse	Nom	description
1	Pa actual	Actual Pascal value
2	Alarme	Fan alarm 0= No fault / 1= Fault

HOLDING REGISTER

adresse	Nom	description
3	Setpoint LOBBY	Setpoint in Pa

OPERATING AND COMMISSIONING INSTRUCTIONS

X.2. MVBL EC MAC2

INPUT REGISTER

Fonction	Description	Exo type	Modbus Adresse	Bacnet Adresse	Défaut value
State of the unit	Modbus : 0= stop 1= starting up 2= Reduced speed starting up 4= Normal speed starting up 5= normal run 9= Night cooling 11= Stop sequence	X	3	MSV,40003	
SAF running tim		R	4	AV,40004	
Air flow	MAC2®	R	15	AV,40015	
Analogue output	0-10V SAF	R	54		

HOLDING REGISTER

Function	Description	Exo type	Modbus Adresse	Bacnet Adresse	Défaut value
Normal airflow setpoint		R	28	AV,30028	xxx
Reduced airflow setpoint		R	29	AV,30029	xxx
Manual mode	MODBUS 0= manual stop 1= reduced air flow manual 2= normal air flow manual 3= Auto BACNET 1= manual stop 2= reduced air flow manual 3= normal air flow manual 4= Auto	X	368	MSV,30368	xx:xx

INPUT STATUT REGISTER

Function	Description	Exo type	Modbus Adresse	Bacnet Adresse	Défaut value
General alarm return	If 1 = ALARM	L	30	BV,20030	
SAF default	If 1 = ALARM	L	33	BV,20033	
Filter guard	If 1 = ALARM	L	38	BV,20038	
Internal battery default	If 1 = ALARM	L	80	BV,20080	

