

OPERATING AND COMMISSIONING INSTRUCTIONS

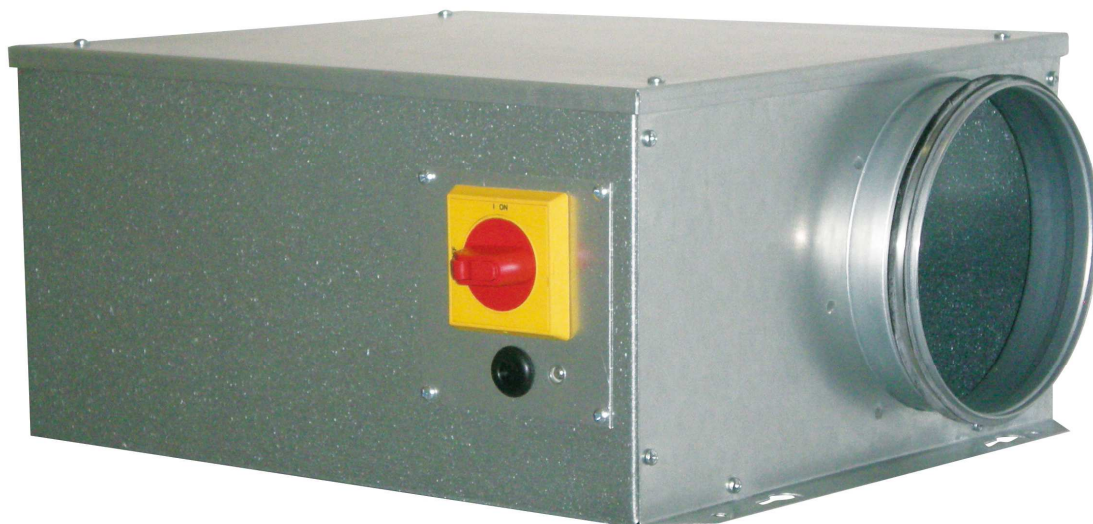

OPERATING AND COMMISSIONING INSTRUCTIONS

I. RECEIVING THE EQUIPEMENT	3
I.1. Checks on reception	3
I.2. Unpacking	3
I.3. Storing	3
I.4. End of life	3
I.5. Handling	3
I.6. Space required	4
I.6.a. MINIMAX	4
I.6.b. MINIBLUE	4
I.7. Installation	4
I.8. Setting up a filter	5
II. GENERAL FONCTIONNING	5
II.1. MINIMAX	5
II.2. MINIBLUE	5
III. ELECTRIC WIRING	5
III.1. MINIMAX	5
III.1.a. MINIMAX 125-250	6
III.1.a. MINIMAX 315-355	6
III.1. MINIBLUE	6
III.1.a. External 0-10V connection	7
III.2. MINIBLUE LOBBY	7
III.2.a. MINIBLUE LOBBY 125-160	7
III.2.a. MINIBLUE LOBBY 200-250	8
III.2.a. MINIBLUE LOBBY 315-400	8
III.2.b. Connection of the pressure tube	8
IV. SETTINGS MINIBLUE LOBBY	9
IV.1.a. Presentation of the controller	9
IV.1.b. Arborescence des menu et parametrage	10
V. MAINTENANCE	11
V.1. Exterior of the box	11
V.2. Fan	11
V.3. Electrical conection	11
V.4. Filtration	11
VI. REPAIR	11
VI.1. MINIMAX MINIBLUE	11
VI.2. MINIBLUE LOBBY	11
VII. MODBUS	12
VII.1. MINIBLUE LOBBY	12
VIII. NOTES	12

OPERATING AND COMMISSIONING INSTRUCTIONS

SAFETY INSTRUCTIONS AND COMPLIANCE WITH REGULATION

In compliance with the current norms, the machine should be installed only by a technical person qualified for this type of work.

Use the required personal protection devices so as to avoid injuries caused by electrical and mechanical hazards (injuries by touching panels, sharp edges, etc.). Use EN170 protective eyewear and ear protection.

Do not use the unit for an other use than design use (Usage in accordance with the intended purpose).

This unit can't be use for dangerous air extraction or supply.

Move the machine as detailed in chapter *handling*.

Grounding has to be carried out in compliance with current standards. Never start the device without grounding.

Before any intervention ensure that device is powered off and wait for complete stop of every rotative component such as damper, fan, rotative exchanger...

During device's run inspection doors must be mounted and closed.

Start has to be done only with padlockable swith.

Do not shut off or short circuit the safety and control equipment.

During interventions, be carefull with hot components such as hot water coil or electric resistances.

The machine should be installed in compliance with fire norms.

The waste must be disposed off in compliance with the current standards. No packaging should be discarded into the environment.

We disclaim any responsibility for any damages resulting from wrong utilisation of the equipment, reparation, modification or no compliance with these instructions.

The device must be installed in accordance with the regulations and rules of the art in force in the installation country.

I. RECEIVING THE EQUIPEMENT

The units are delivered on stringers or palettes then wrapped in plastic film

1.1. Checks on reception

When the equipment is received, the state of the packaging and the equipment must be checked. In the event of damage, make an accurate note of any problems on the carrier's delivery note

1.2. Unpacking

When the equipment is unpacked, check the following:

- The total number of packages is present.
- All accessories are present. After unpacking the equipment, the waste must be disposed off in compliance with the current standards. No packaging should be discarded into the environment

1.3. Storing

The equipment must be stored in shade, in a dry place, at a temperature between -20°C and 40°C. The packaging can't be considered sufficient for an external storage.

1.4. End of life

In accordance with our partnership with the compagny ECOLOGIC, CALADAIR fulfills the obligations to finance the collection, removal and treatment of Electrical and Electronic Equipment Waste.

At the equipment end of the life, the user contacts the company ECOLOGIC who will propose a collection solution or a place for product deposit.

Contacts for pick-up requests:

E-mail: operations-pro@ecologic-france.com

Phone: + 33 130 57 79 14

Internet: www.e-dechet.com

1.5. Handling

The units must only be moved in their installation position.

If the device is handled using a fork-lift truck, ensure this supports the load-bearing structure.

If the device is moved using a crane, use four cables of identical lengths. These must be at least as long as the greatest distance between two fastening points.

If $L + W + H > 5m$ P then the case must be lifted using a lifting beam

OPERATING AND COMMISSIONING INSTRUCTIONS

1.6. Space required

Generally speaking, it is desirable to provide access space for maintenance. We advise 1 time unit height on each side for maintenance.

1.6.a. MINIMAX

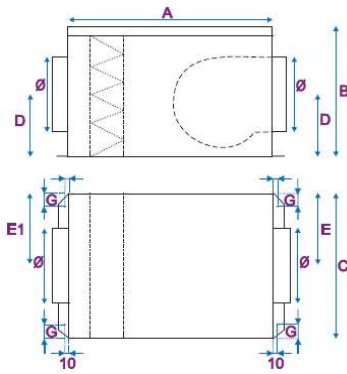

Range MINIMAX®	A	B	C	Ø	D	E1	E	G	Weight (kg)	
	mm	mm	mm	mm	mm	mm	mm	mm	NI	PHONIC
125	515	235*	370	125	120	185	185	50	10	12
160	515	235*	370	160	120	185	185	50	10	12
200	590	260*	420	200	125	210	210	60	14	16
250	540	335*	450	250	165	225	225	60	16	19
315	470	385	450	315	205	225	225	60	20	23
316	470	385	450	315	205	225	225	60	22	25
355	570	475	550	355	275	275	275	60	28	33

* Height PHONIC VERSION = B + 25mm

1.6.b. MINIBLUE

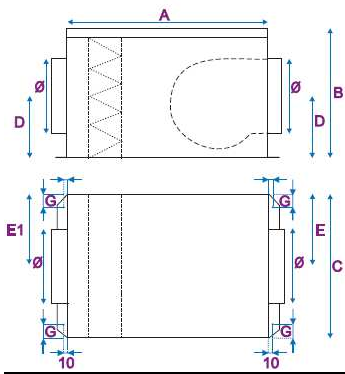

Range MINIBLUE®	A	B	C	Ø	D	E1	E	G	Weight
	mm	mm	mm	mm	mm	mm	mm	mm	kg
125	515	260	370	125	120	185	185	50	12
160	515	260	370	160	120	185	185	50	12
200	590	290	420	200	125	210	210	60	16
250	540	360	450	250	165	225	225	60	19
315	470	385	450	315	205	225	225	60	23
355	570	475	550	355	275	275	275	60	30
400	570	475	550	400	250	275	275	60	31

1.7. Installation

The unit must be suspended or laid on a sufficiently rigid and flat surface (use vibration mounts if necessary). For the HVAC connection, select duct sections based on dimensions of the flexible bands that should be properly stretched.

Install the unit in such a way that bad weather or ambient temperature cannot damage internal items during installation or later use (provide a protective cap if necessary).

If inlet or outlet are not ducted, provide a protective grid.

Outdoor installation of boxes:

An outdoor unit must always be attached to the floor of the support frame so that it can not move or fall (take into account the force of the wind). Also provide a mesh beveled nozzle (BBG) if necessary (optional)

Indoor installation of boxes:

The devices should preferably be placed on a frame suspended from the structure of the building, taking care to respect the permissible loads (chassis at the expense of the installer).

However, the MINIMAX® and MINIBLUE® systems can be suspended directly from the ceiling by M8 threaded rods connected to the brackets at the bottom of the boxes.

Aeraulic connection:

For the ventilation connection, select the duct sections in relation with the dimensions of the flexible bands, which must be correctly tensioned. Ducting may have to be insulated if necessary. Ducting must be realized in accordance with the general building regulations (no elbow at the exit of fan before a minimum distance of 5 times the diameter of collar saddle, and in entry, no elbow before a minimum distance of 2.5 times the diameter of collar saddle).

The direction of the air is noted on the label.

OPERATING AND COMMISSIONING INSTRUCTIONS

1.8. Setting up a filter

When the filter is not mounted at the factory, the 2 rails positioned in the bottom of the box fan must be fixed using the self-drilling screws 3.9x13 supplied. 2 markers marks you where to screw from the outside. You will need to cut the rockwool over the entire height of the filter for MINIBLUE and MINIMAX PHONIC



II. GENERAL FONCTIONNING

II.1. MINIMAX

Equipped with a proximity switch as standard, this extraction or insufflation box fan accepts variation by Autotransfo (CATM-VATM) and electronic voltage regulator (VEC-REG-RES). It consists of a Direct-coupled motor with integrated thermal cutout.

Sizes 125 to 250 are equipped with reaction turbine with single opening.

Sizes 315 to 355 are equipped with impulse turbine with double opening.

These boxfans can also be equipped with a filter in the case of an insufflation application.

125 to 250 models are available in 3 speeds.

II.2. MINIBLUE

Equipped with a proximity switch as standard, this extraction or insufflation box fan is equipped with Direct Drive DC motor with integrated thermal cutout.

Sizes 125 to 250 are equipped with reaction turbine with single opening.

Sizes 315 to 400 are equipped with impulse turbine with double opening.

They are also equipped with a potentiometer for a suitable and optimal adjustment of the flow.

III. ELECTRIC WIRING

The electrical connection must be carried out according to the regulations in force

III.1. MINIMAX

Range MINIMAX®	Power supply voltage (V / Ph / Hz)	Power rating (W)	Protection current (A)	Usage Temp (°C / °C)	Motor IP / Class	Thermal cutout*	Speed variation
MINIMAX® 125	230 / 1 / 50	52	0,23	-25 / 60	IP44 / B	PTI	AUTOTRANSFORMER OR ELECTRONIC
MINIMAX® 160	230 / 1 / 50	52	0,23	-25 / 60	IP44 / B	PTI	
MINIMAX® 200	230 / 1 / 50	102	0,45	-25 / 60	IP44 / F	PTI	
MINIMAX® 250	230 / 1 / 50	155	0,68	-25 / 60	IP44 / F	PTI	
MINIMAX® 315	230 / 1 / 50	147	1,6	-20 / 40	IP55 / F	PTI	
MINIMAX® 316	230 / 1 / 50	300	2,4	-20 / 40	IP55 / F	PTI	
MINIMAX® 355	230 / 1 / 50	420	3,9	-20 / 40	IP55 / F	PTI	

*PTI : Integrated thermal cutout

OPERATING AND COMMISSIONING INSTRUCTIONS

III.1.a. MINIMAX 125-250

You can switch from LS to HS in 2 ways: changeover contact or simple switch

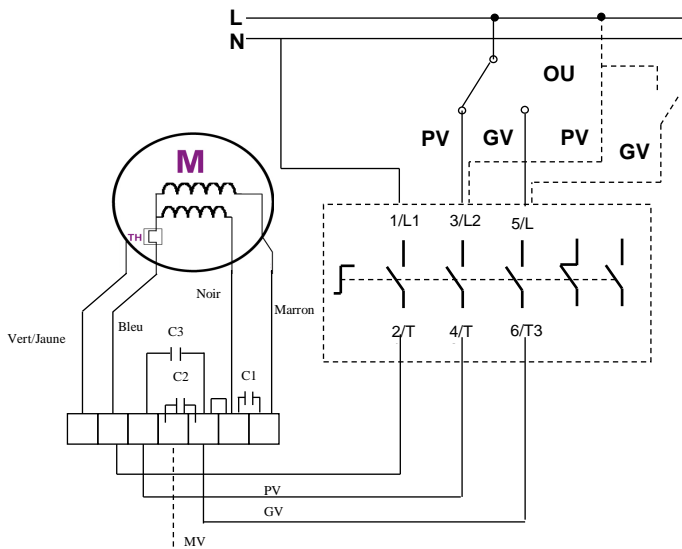

MS: You have the possibility to increase the low speed LS at medium speed MS or decrease the high speed HS at medium speed MS.
To do this, simply unplug the LS or HS wire and plug it in place of the MS dotted line.

III.1.a. MINIMAX 315-355

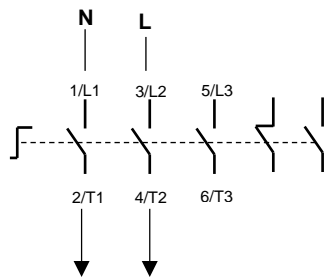

IPC1V5
MINIMAX 315-355

III.1. MINIBLUE

Range MINIBLUE®	Power supply voltage (V / Ph / Hz)	Power rating (W)	Protection current (A)	Usage Temp (°C / °C)	Motor IP / Class	Thermal cutout*
MINIBLUE® 125	230 / 1 / 50	83	0,75	-25 / 60	IP54 / B	PTI
MINIBLUE® 160	230 / 1 / 50	83	0,75	-25 / 60	IP54 / B	PTI
MINIBLUE® 200	230 / 1 / 50	85	0,7	-25 / 60	IP54 / B	PTI
MINIBLUE® 250	230 / 1 / 50	170	1,4	-25 / 60	IP54 / B	PTI
MINIBLUE® 315	230 / 1 / 50	1070	4,3	-25 / 40	IP44 / F	PTI
MINIBLUE® 355	230 / 1 / 50	1040	4,5	-25 / 40	IP44 / F	PTI
MINIBLUE® 400	230 / 1 / 50	1040	4,5	-25 / 40	IP44 / F	PTI

*PTI : Integrated thermal cutout

OPERATING AND COMMISSIONING INSTRUCTIONS

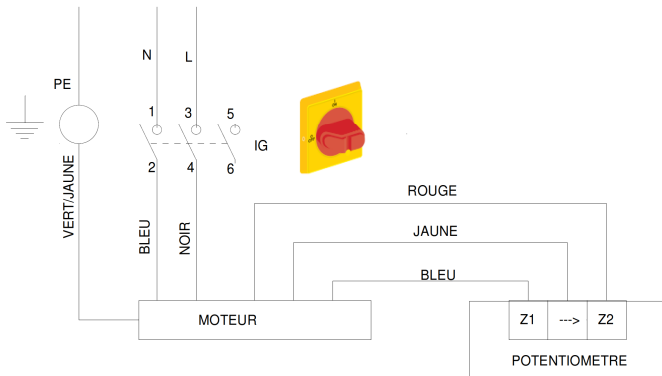

125-250

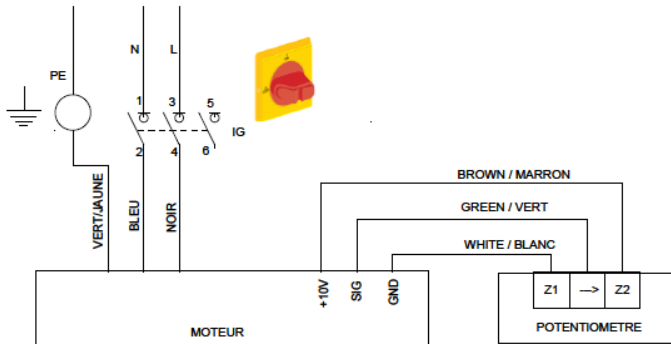

315-400

III.1.a. External 0-10V connection

Possibility to connect an external 0-10V:

MINIBLUE® 125 to 250: disconnect the blue and yellow wire from the potentiometer (blue = 0V / yellow = 0-10V)

MINIBLUE® 355 to 400: disconnect the white and green wire of the potentiometer (white = 0V / green = 0-10V)

III.2. MINIBLUE LOBBY

III.2.a. MINIBLUE LOBBY 125-160

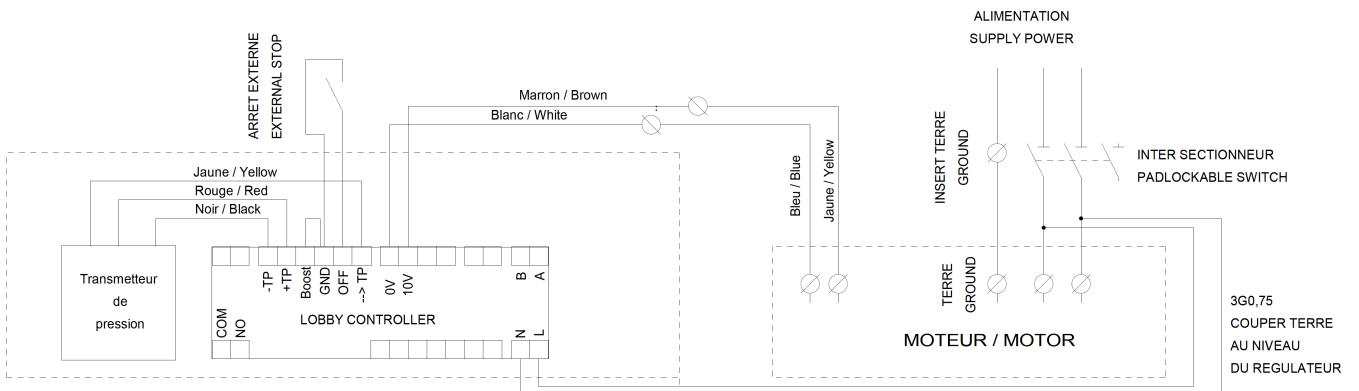

OPERATING AND COMMISSIONING INSTRUCTIONS

III.2.a. MINIBLUE LOBBY 200-250

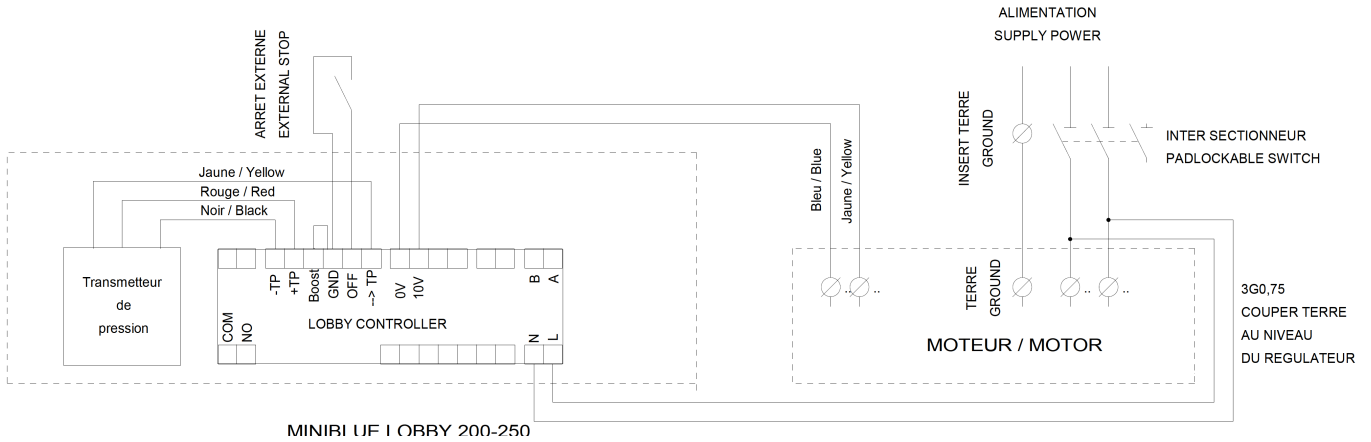

III.2.a. MINIBLUE LOBBY 315-400

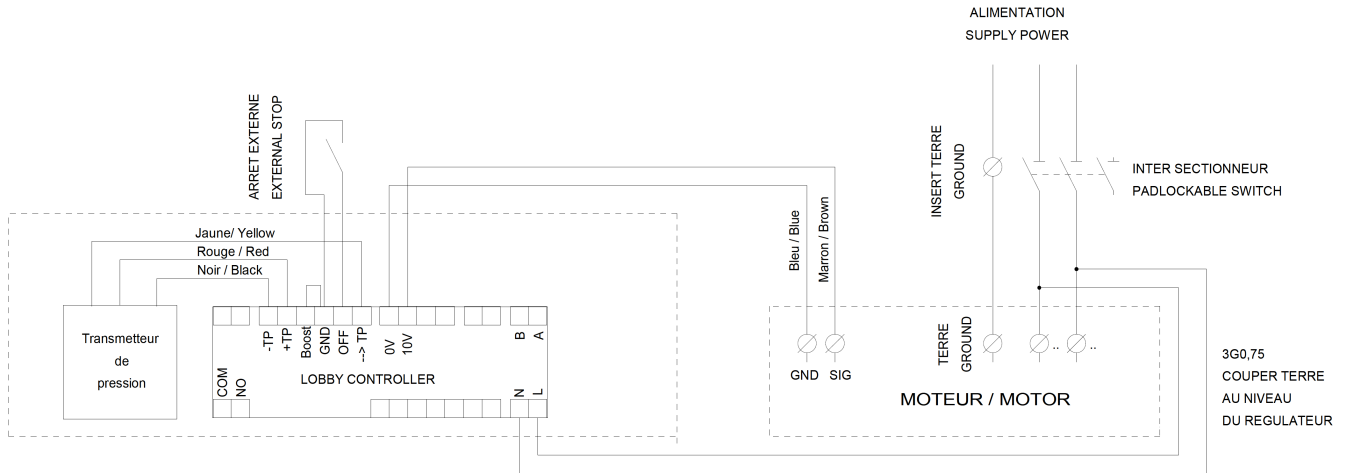

III.2.b. Connection of the pressure tube

Extraction (mounted as standard): The - is connected to the box and the + remains in the open air
 Blow: The + has to be connected to the blowing duct and the - remains in the open air





OPERATING AND COMMISSIONING INSTRUCTIONS

IV. SETTINGS MINIBLUE LOBBY

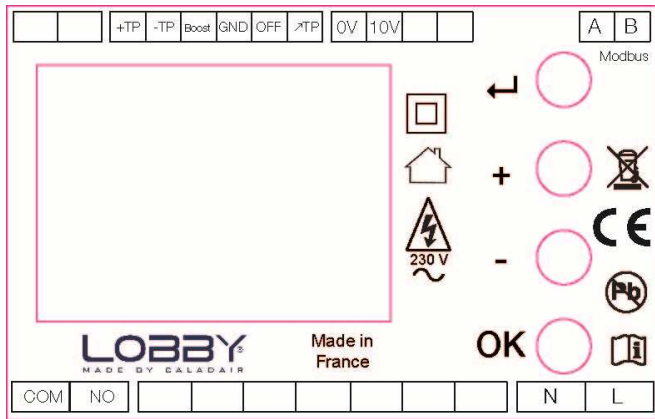
IV.1.a. Presentation of the controller

Setting is done entirely via the regulator preinstalled on the box MINIBLUE LOBBY®



-  Welcome screen return
-   Change value
-  Validate value
Access to pressure setting
Access to the service menu by long press

OPERATING AND COMMISSIONING INSTRUCTIONS

IV.1.b. Menus arborescence and parameters

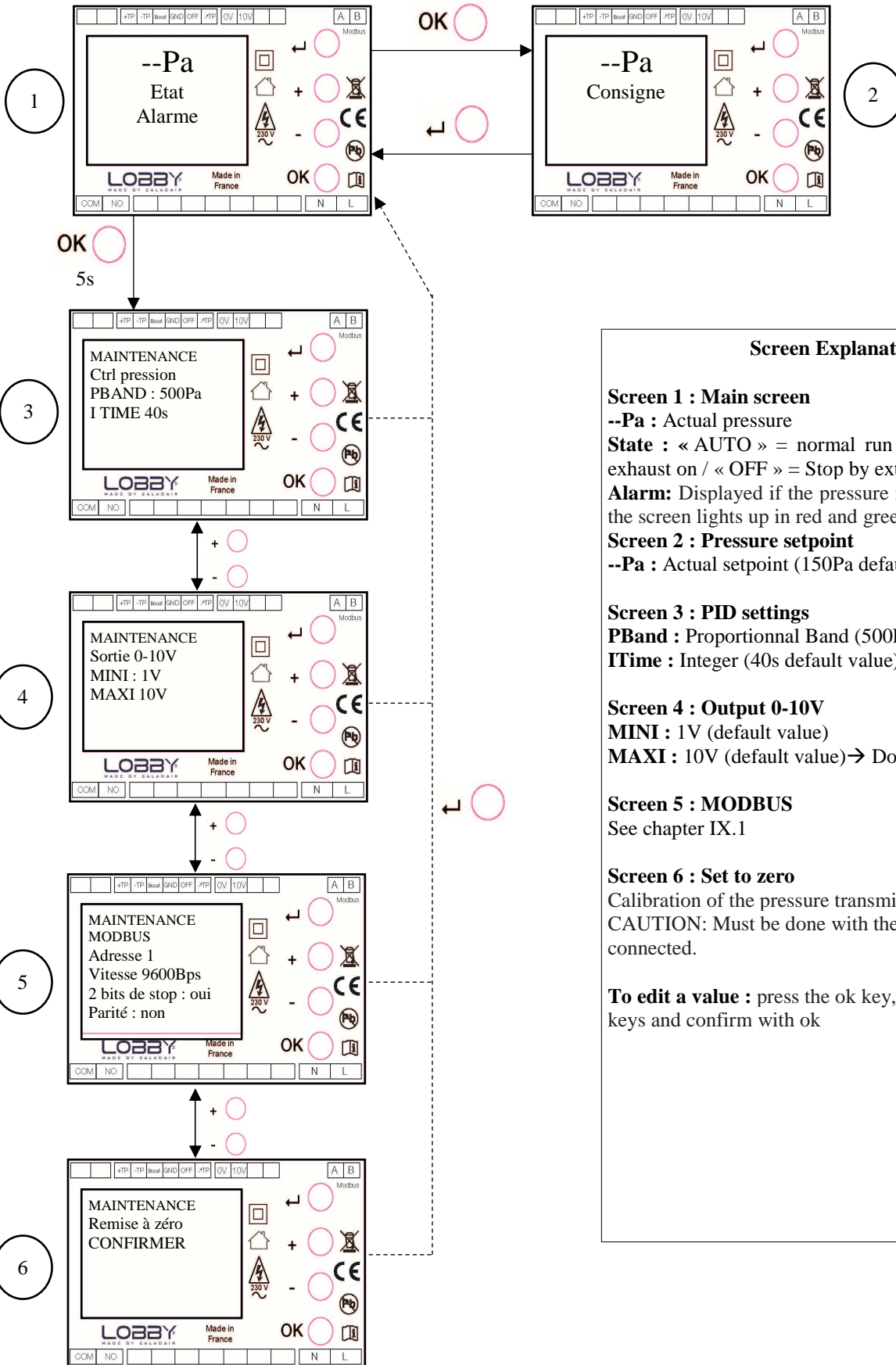

Screen Explanations

Screen 1 : Main screen

--Pa : Actual pressure

State : « AUTO » = normal run / « BOOST » = fire exhaust on / « OFF » = Stop by external contact

Alarm: Displayed if the pressure is <80Pa. In this case the screen lights up in red and green

Screen 2 : Pressure setpoint

--Pa : Actual setpoint (150Pa default value)

Screen 3 : PID settings

PBand : Proportionnal Band (500Pa default value)

ITime : Integer (40s default value)

Screen 4 : Output 0-10V

MINI : 1V (default value)

MAXI : 10V (default value) → Do not change

Screen 5 : MODBUS

See chapter IX.1

Screen 6 : Set to zero

Calibration of the pressure transmitter.

CAUTION: Must be done with the pressure tap not connected.

To edit a value : press the ok key, change with the +/- keys and confirm with ok

OPERATING AND COMMISSIONING INSTRUCTIONS

V. MAINTENANCE

Before beginning any maintenance or repair work, it is essential to electrically isolate the box fan by opening the Proximity Lockable Switch (IPC) (OFF Position). The maintenance and decommissioning of the installations must be carried out under the conditions ensuring compliance with applicable environmental regulations. The maintenance must be ensured at least once a year or according to the applicable regulatory requirements (fire safety ...) Depending on the installation conditions, the control frequency can be further reduced.

V.1. Exterior of the box fan

Check ducts, flexible cuffs and anti-vibration pads, replace if necessary. Check that all the elements connected to the box are in place so that no vibration can be transmitted to the external element

V.2. Fan

Dust the turbine and the volute if necessary.

V.3. Electrical connection

Check connections and insulators regularly.

V.4. Filtration

The filters are to be replaced every year or more if necessary

VI. REPAIR

For any other defect or anomaly found, and in case of inefficiency of repair, contact the After Sales Service.

Defective parts must be replaced exclusively with original components (compliance with applicable product regulations)

VI.1. MINIMAX MINIBLUE

Nature of the defect	Probable cause	Solutions
The box does not start	Box not powered HS motor Potentiometer or external signal 0-10V MINIBLUE on 0	Check the presence of voltage Check that the switch is ON

VI.2. MINIBLUE LOBBY

Nature of the defect	Probable cause	Solutions
The box fan does not start + nothing on display	Box not powered Motor out of order	Check the presence of voltage Check that the switch is ON
The box fan does not start	Startup delay	Wait 1 minute before the box starts
The box fan does not start + OFF displayed on screen	External stop (ON)	Open the external stop
The box is at maximum ("BOOST" displayed on the screen)	TK wire (thermo safety contact) cut Extract Air above 70 ° C	Restart the box Change or rewire the TK (thermo safety contact)
0 Pa displayed on the screen + « ALARME » displayed on the screen The screen flashes red/green	TP tube (pressure transmitter) disconnected TP connection problem (pressure transmitter)	Check the TP air connection (pressure transmitter, tube must be connected -) (black pressure tap) Check the electrical connection of the TP (pressure transmitter)

