

UTY-VTGX

INSTALLATION MANUAL

NETWORK CONVERTOR

For authorized service personnel only.

English

INSTALLATIONSANLEITUNG

NETZWERKKONVERTER

Nur für autorisiertes Fachpersonal.

Deutsch

MANUEL D'INSTALLATION

ADAPTATEUR RESEAU

Pour le personnel agréé uniquement.

Français

MANUAL DE INSTALACIÓN

CONVERTIDOR DE RED

Únicamente para personal de servicio autorizado.

Español

MANUALE DI INSTALLAZIONE

CONVERTITORE DI RETE

A uso esclusivo del personale tecnico autorizzato.

Italiano

ΕΓΧΕΙΡΙΔΙΟ ΕΓΚΑΤΑΣΤΑΣΗΣ

ΜΕΤΑΤΡΟΠΕΑΣ ΔΙΚΤΥΟΥ

Μόνο για εξουσιοδοτημένο τεχνικό προσωπικό.

Ελληνικά

MANUAL DE INSTALAÇÃO

CONVERSOR DE REDE

Apenas para técnicos autorizados.

Português

РУКОВОДСТВО ПО УСТАНОВКЕ

СЕТЕВОЙ КОНВЕРТОР

Только для авторизованного обслуживающего персонала.

Русский

MONTAJ KILAVUZU

AĐ DÖNÜŞTÜRÜCÜ

Yalnızca yetkili servis personeli için.

Türkçe

安装说明书

网络信号转换器

仅针对授权的专业维修人员。

中文

富士通将军有限公司
FUJITSU GENERAL LIMITED



[Original instructions]

PART NO. 9374707195

INSTALLATION MANUAL

PART NO. 9374707195
NETWORK CONVERTOR

Contents

1. SAFETY PRECAUTIONS	1
2. MAIN UNIT AND ACCESSORIES	1
3. ELECTRICAL REQUIREMENT	2
4. SELECTING AN INSTALLATION LOCATION	2
4. 1. Dimensions	2
5. WIRING.....	2
5. 1. Wiring method	3
5. 2. Unit wiring	4
6. INSTALLING THE NETWORK CONVERTOR.....	4
6. 1. Connecting the transmission cables	4
7. CONNECTION OF REMOTE CONTROLLER CABLE	5
8. CIRCUIT BOARD SETTING	6
9. TURNING ON THE POWER	7
10. LED DISPLAY	7
10. 1. Normal code	7
10. 2. Error code	7

1. SAFETY PRECAUTIONS

- The "SAFETY PRECAUTIONS" indicated in this manual contain important information pertaining to your safety. Be sure to observe them.
- Request the user to keep this manual on hand for future use, such as for relocating or repairing the unit.

WARNING

This mark indicates procedures which, if improperly performed, might lead to the death or serious injury of the user.

Perform electrical work by an authorized service personnel in accordance with this manual and the electrical wiring regulations or implementation regulations of the country. Also do not install this unit by yourself. Improper electric work will cause electric shock or a fire.

Perform installation work in accordance with this manual. Request an authorized service personnel to perform installation work. Do not install this unit by yourself. Improper installation will cause injury, electric shock, fire, etc.

In the event of a malfunction (burning smell, etc.), immediately stop operation, turn off the electrical breaker, and consult authorized service personnel.

Do not install the unit in the following areas:

- Do not install the unit near a source of heat, steam, or flammable gas.
- Area filled with mineral oil or containing a large amount of splashed oil or steam, such as a kitchen. It will deteriorate plastic parts, causing the parts to fail or the unit to leak water.
- Area that generates substances that adversely affect the equipment, such as sulfuric gas, chlorine gas, acid, or alkali. It will cause the copper pipes and brazed joints to corrode, which can cause refrigerant leakage.
- Area containing equipment that generates electromagnetic interference. It will cause the control system to malfunction, preventing the unit from operating normally. Area that can cause combustible gas to leak, contains suspended carbon fibers or flammable dust, or volatile inflammables such as paint thinner or gasoline. If gas leaks and settles around the unit, it can cause a fire.
- Do not use the unit for special purposes, such as storing food, raising animals, growing plants, or preserving precision devices or art objects. It can degrade the quality of the preserved or stored objects.
- Install the unit in a well-ventilated place avoiding rains and direct sunlight.

Do not operate this unit when your hands are wet. Touching the unit with wet hands will cause an electric shock.

If children may approach the unit, take preventive measures so that they cannot reach the unit.

CAUTION

This mark indicates procedures which, if improperly performed, might possibly result in personal harm to the user or damage to property.

Pay abundant care when transporting this unit because it is a precision device. Improper transportation will cause trouble.

Do not touch the switches with sharp objects. Doing so will cause injury, trouble, or electric shock.

Do not expose this unit directly to water. Doing so will cause trouble, electric shock, or heating.



Do not set vessels containing a liquid on this unit. Doing so will cause heating, fire, or electric shock.

Dispose of the packing materials safely. Tear and dispose of the plastic packing bags so that children cannot play with them. There is the danger of suffocation if children play with the original plastic bags.

Do not insert articles into the slit parts of this unit. Doing so will cause trouble, heating, or electric shock.

2. MAIN UNIT AND ACCESSORIES

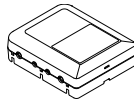
The following installation parts are supplied. Use them as required.

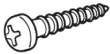
Name and Shape	Q'ty	Application
 Network converter	1	Main unit
 Installation manual	1	This manual
 Cable tie	4	For mounting the remote controller cable and transmission cable.
 Screw (M4 x 16 mm)	3	For mounting the network convertor.

3. ELECTRICAL REQUIREMENT

Use	Size	Cable type	Remarks
Transmission cable	0.33 mm ² (22AWG)	22AWG LEV-EL4 (NEMA) nonpolar 2 core, twisted pair solid core Shielded	LONWORKS® compatible cable
Remote controller cable (2-wire type)	0.33 to 1.25 mm ² (16~22AWG)	Sheathed PVC cable*	Non-polar 2 core, twisted pair
Remote controller cable (3-wire type)	0.33 mm ² (22AWG)	Sheathed PVC cable*	Polar 3core

*: Use shielded cable in accordance with local rules for remote controller cable.

4. SELECTING AN INSTALLATION LOCATION

4.1. Dimensions

The network convertor is comprised of a body and cover.

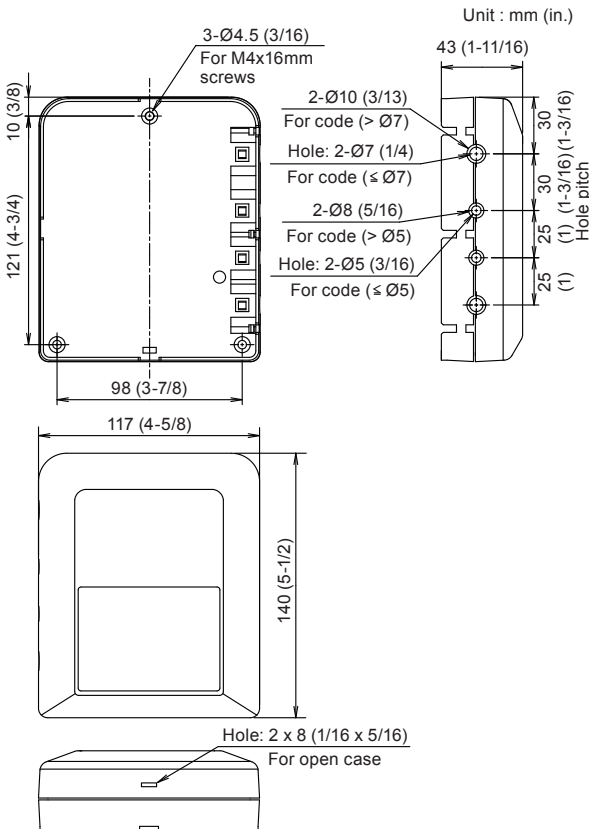

Power consumption (W)		1.2
Temperature °C (°F)	Operating	0–46 (32–114)
	Packaged	-10–60 (14–140)
Humidity (%)	Packaged	0–95 (RH); No condensation
Dimensions H x W x D mm (in.)		43 x 117 x 140 (1-11/16 x 4-5/8 x 5-1/2)
Weight g (oz.)		250 (9)

5. WIRING

⚠ WARNING

Before starting installation work, turn off the power of this unit and the connection destination. Do not turn on the power again until installation is completed. Otherwise, it will cause electric shock or fire.

Use the accessories or specified transmission cable. Do not modify power supply cable and transmission cables other than those specified, do not use extension cables, and do not use independent branch wiring. It may cause electric shock or fire.

Install the transmission cables securely to the terminal block. Confirm that external force is not applied to the cable. Use transmission cables made of the specified cable. If intermediate connection or insertion fixing are imperfect, it will cause electric shock, fire, etc.

When connecting the transmission cable, route the cables so that the cover of this unit is securely fixed. If the cover is imperfectly fixed, it may cause fire or overheating of the terminals.

Perform earth (ground) work positively. Do not connect the earth (ground) cable to a telephone cable, water pipe, or conductor rod.

Always fasten the outside covering of the transmission cables with the cable clamp. (If the insulator is chafed, electric leakage may occur.)

Perform all wiring works so that the user does not touch the wiring. Doing so will cause injury or electric shock.

If any cable is damaged, do not repair or modify it yourself. Improper work will cause electric shock or fire.

⚠ CAUTION

Do not bind the remote controller cable and the transmission cable together with or parallel to the power supply cable of the indoor and outdoor units. It may cause erroneous operation.

When performing wiring work, be careful not to damage the cable or injure yourself. Also, connect the connectors securely. Loose connectors will cause trouble, heating, fire, or electric shock.

Install the indoor and outdoor units, power supply cable, transmission cable and remote controller cable 1 m (40 in.) away from television and radio to avoid distorted images and noise. Otherwise, a malfunction could result.

Perform wiring so that water does not enter this unit along the external wiring. Always install a trap to the wiring or take other countermeasures. Otherwise it will cause trouble or electric shock or fire.

Confirm the name of each unit and name of each terminal block of the unit and connect the wiring in accordance with the directions given in the manual so that there is no incorrect wiring. Incorrect wiring will damage the electric parts and cause smoke and fire.

When installing the transmission cables near a source of electromagnetic waves, use shielded cable. Otherwise, a breakdown or malfunction could result.

The terminal screws and earth (ground) screws have different shapes. Be sure to install the screws in the correct locations. If the screws are installed in the wrong locations, the circuit board could be damaged.

5. 1. Wiring method

5. 1. 1. Setting method when connecting a single split indoor unit

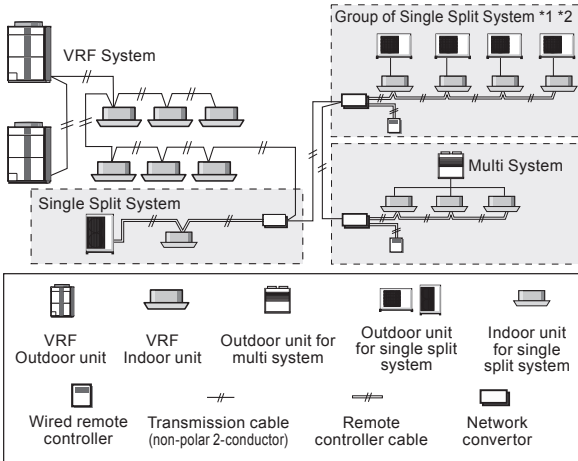

Connectable types of indoor unit and remote controller

●Connectable remote controllers

3 models of wired remote controller shown in the table below can be connected to this unit.

The indoor unit that can be connected is the indoor unit that can connect to following remote controller.

Model name	RC number	Type
UTY-R*R*	AR-WEC**	Non-polar 2 wire
	AR-WED**	
	AR-WEE**	
	AR-WFA**	
	AR-WFB**	
	AR-WFC**	
	AR-WFD**	
	AR-WGA**	
UTB-*UD	AR-6TC**	Polar 3 wire
UTY-R*N**	AR-WAE**	Polar 3 wire
	AR-WAF**	
	AR-WAG**	
	AR-WBE**	
	AR-WBF**	
	AR-WDC**	

(* arbitrary character)

●About operation of remote controller for each type to be connected

Operation	Non-polar 2 wire	Polar 3 wire
Operation of louver from VRF	○	×
Operation of louver from wired remote controller	○	○
Restriction of wireless remote controller from central	○	×
Restriction of wired remote controller from central	○	○
Antifreeze	×	×
Setting high and low temperature limit	○	×
Indoor unit rotation	×	×
Turning off indoor unit external thermostat	×	×
Outdoor unit forced stop	×	×
Outdoor unit capacity save	×	×
Outdoor unit low noise	×	×
Electricity distribution	×	×
Display model name	×	×
System time	○	×
Remote setting	×	×
Local setting by the wired remote controller	○	×

[Example of connecting single split type indoor unit in a parallel arrangement]

Case 1: For non-polar 2 wire

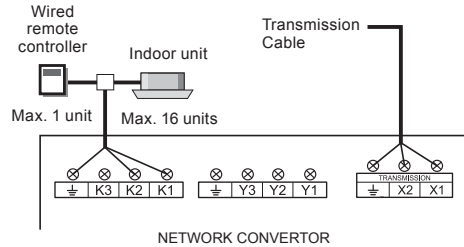

Case 2: For polar 3 wire

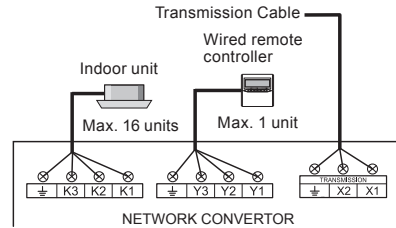

- Up to 16 indoor units may be controlled with a single network convertor, however multiple indoor units connected to the network convertor are generally required to have the same operation setting.
- Connect a single multi system to a single network convertor. 2 units or more of multi systems cannot be connected. Multi system and single split system can also be connected simultaneously.

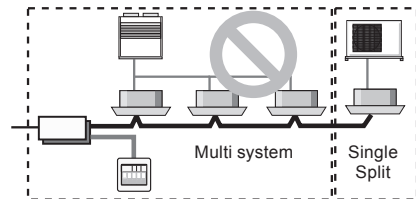

- Ex. 1) If FAN setting is selected from the control unit, the LED on the indoor unit will flash and the unit will enter the operation standby condition. Select another operation mode to clear the standby condition.
- Ex. 2) If an operation mode that is different from a currently operating indoor unit is selected from the control unit, the LED on the indoor unit will flash and the unit will enter the operation standby condition. Select the operation mode of the currently operating indoor unit to clear the standby condition. Or, if operation becomes possible, such as by stopping the other indoor unit, the standby condition will be cleared and the indoor unit will automatically start operating with the selected mode.

5. 2. Unit wiring

5. 2. 1 Transmission and Remote controller cable

Transmission cable

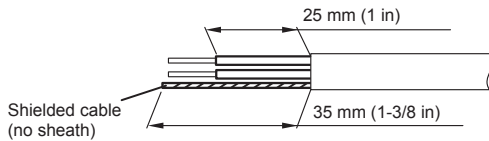

Remote controller cable

For 2-wire type

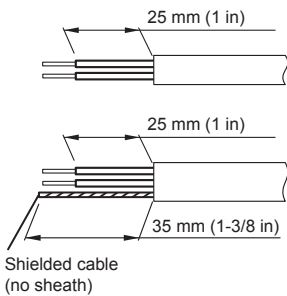

For 3-wire type

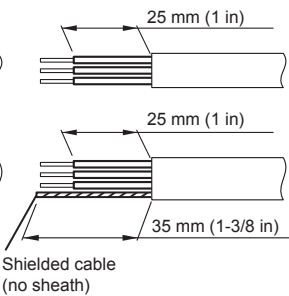

⚠ WARNING

Tighten the terminal screws to the specified torques, otherwise, abnormal overheating may be occurred and possibly cause heavy damage inside the unit.

Tightening torque

M3 screw (Transmission / X1, X2) (Remote controller / Y1, Y2, Y3, K1, K2, K3)	0.5 to 0.6 N·m (4.4 to 5.3 lbf·in) (5 to 6 kgf·cm)
--	--

⚠ CAUTION

To peel the sheath from the lead cable, use a dedicated tool that will not damage the conductor cable.

When installing a screw on the terminal block, do not cut the cable by overtightening the screw. On the other hand, an under tightened screw can cause faulty contact, which will lead to a communication failure.

6. INSTALLING THE NETWORK CONVERTOR

⚠ WARNING

Always use the accessories and specified installation work parts. Check the state of the installation parts. Not using the specified parts will cause units to fall off, electric shock, fire, etc.

Install at a place that can withstand the weight of the unit and install positively so that the unit will not topple or fall.

When installing this unit, make sure that there are no children nearby. Otherwise, injury or electric shock could result.

⚠ CAUTION

Do not set the DIP switch or rotary switch of this unit except as specified in this installation manual or the instruction manual supplied with the air conditioner. Setting the switches other than specified will cause an accident or trouble.

Use an insulated screwdriver to set the DIP switches.

Before opening the cover of this unit, completely discharge static electricity charged on your body. Otherwise, failure or malfunction could result.

Do not touch the circuit board and circuit board parts directly with your hands. Otherwise, injury or electric shock could result.

Tightening the mounting screws too tight will damage the body of this unit.

Be careful so that the cover does not fall after the cover screws are removed. Otherwise, injury could result.

6. 1. Connecting the transmission cables

- Turn off the power of the connecting unit.
- Insert a screwdriver, etc., into the hole (For open case) and open the top cover.

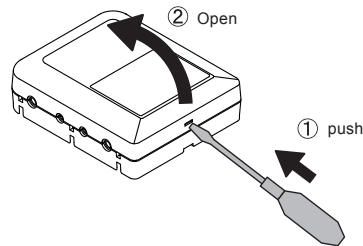

- Connect the transmission cable and remote controller cable to their respective terminal block properly.
- Securely tighten the cable tie and then confirm that the cable will not come out.
- Use the 3 screws (M4 × 16 mm) provided to mount the network convertor to the behind ceiling, wall, floor or other suitable location.
- Once the wiring of the cables is completed, snap in the 2 hooks on the top cover and close the top cover.

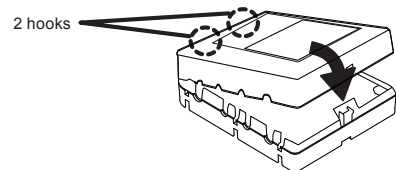

* The hole for a cable can be widened as necessary. When passing the thick cable through the hole, widen it.

Case 1: For non-polar 2 wire

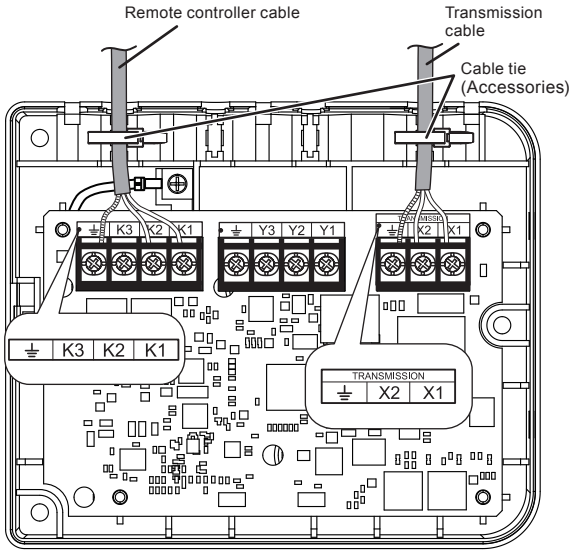

Case 2: For polar 3 wire

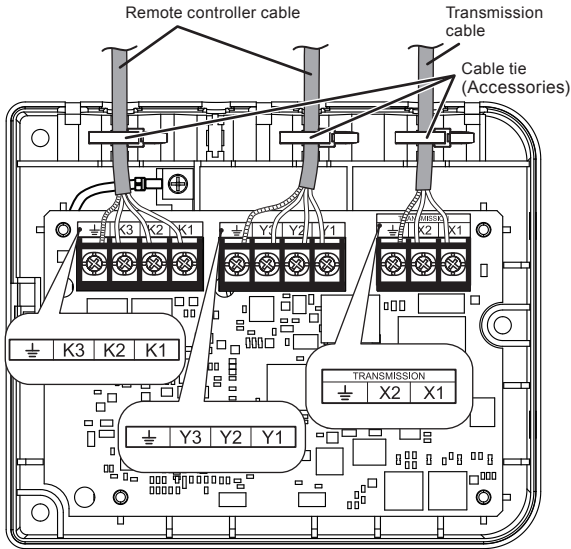

Fix the connector cable even outside the main unit as necessary.
Fix the cable with cable tie using 3 fixing holes.

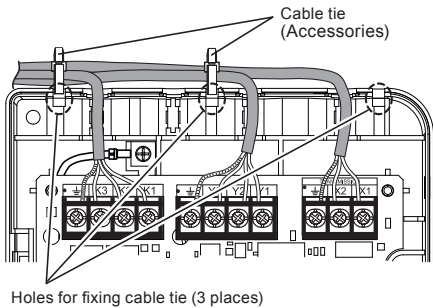

7. CONNECTION OF REMOTE CONTROLLER CABLE

CAUTION

When connecting the remote controller cable to the indoor unit, do not connect it to the outdoor unit or the power terminal block. It may cause a failure.

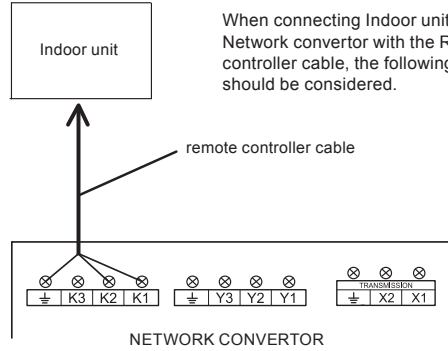

When connecting Indoor unit and Network converter with the Remote controller cable, the following items should be considered.

There are 2 methods to connect the remote controller cable to the indoor unit. One is the connection using contained connecting cable, and the other is the connection the remote controller cable is connected to the exclusive terminal block of the indoor unit. Exclusive terminal block for remote controller connection method is different depending on each model. Modify the remote controller cable as per below description and connect it. (For the details, refer to the installation manual of the indoor unit to be used.)

(1) When connecting to the connector

Case 1: For non-polar 2 wire

Use a tool to cut off the terminal on the end of the remote controller cable, and then remove the insulation from the cut end of the cable as shown in Fig. 1. Connect the remote controller cable and connecting cable as shown in Fig. 2. Be sure to insulate the connection between the cables.

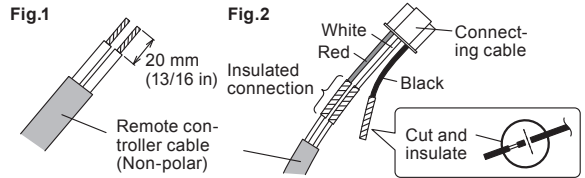

Connect the remote controller cable to the connecting cable, and insert it to the connector. Set to "2WIRE" the DIP switch (SW1) on the PC board of the indoor unit.

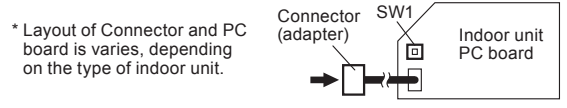
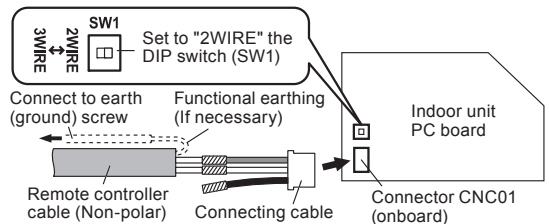

Case 2: For polar 3 wire

Modify the cable as per below methods.

Use a tool to cut off the terminal on the end of the remote controller cable, and then remove the insulation from the cut end of the cable as shown in Fig. 1.

Connect the remote controller cable and connecting cable as shown in Fig. 2.

Be sure to insulate the connection between the cables.

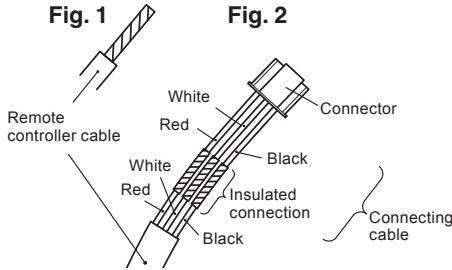

Connect the remote controller cable to the connecting cable, and insert it to the connector.

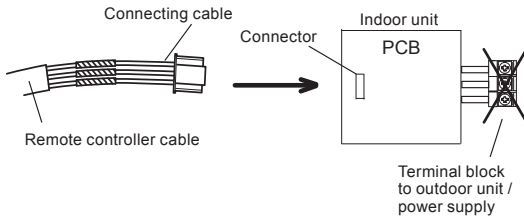

(2) When connecting to the exclusive terminal block

Connect the end of remote controller cable directly to the exclusive terminal block.

Connect all the wires to the exclusive terminal block regardless of being non-polar 2 wire or polar 3 wire.

If there is the 2WIRE/3WIRE switch on the PC board of the indoor unit, set it to match the connection method of the connected remote controller cable.

Example) Connection of non-polar 2 wire

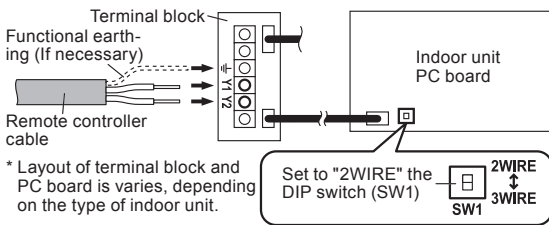

* Layout of terminal block and PC board is varies, depending on the type of indoor unit.

8. CIRCUIT BOARD SETTING

Set network convertor rotary switch SET1, and DIP switch SET2, SET3

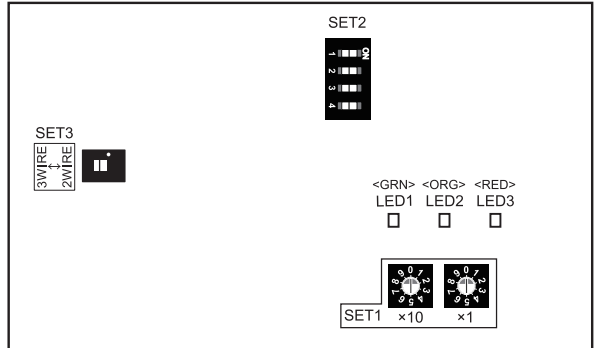

(1) [Rotary switch-SET1] set the refrigerant circuit address

A single network convertor is considered as a single refrigerant system, irrespective of the number of connected single models.

In the case of multiple refrigerant system, set SET1 (x10) and SET1 (x1) as shown in the following table for each Network convertor.

Example: When SET1 (x10) is set to "2" and SET1 (x1) is set to "0", the refrigerant circuit address will be "20".

Refrigerant circuit address	Rotary Switch Setting		Refrigerant circuit address	Rotary Switch Setting	
	SET1 (x10)	SET1 (x1)		SET1 (x10)	SET1 (x1)
0	★0	★0	11	1	1
1	0	1	12	1	2
2	0	2	13	1	3
3	0	3	14	1	4
4	0	4	15	1	5
5	0	5	16	1	6
6	0	6	17	1	7
7	0	7	⋮	⋮	⋮
8	0	8	98	9	8
9	0	9	99	9	9
10	1	0			

(★: Factory setting)

(2) Terminal resistance setting SW (SET2-1)

When there is no other terminal resistance in the network segment to which the convertor is connected, set to "ON".

ON: Terminal resistance valid

OFF: Terminal resistance invalid (Factory setting)

(3) Used remote controller setting SW (SET2-4)

Change the DIP switch setting depending on the remote controller model name attached to the indoor unit.

ON: Wireless remote controller model name :

AR-RAK1E, AR-RHB1E

3-wire type wired remote controller model name :

AR-WAG1E (UTY-RNNGU)

OFF: Other than the above remote controllers (Factory setting)

When 2-wire type remote controller is connected, set to "OFF" for all models.

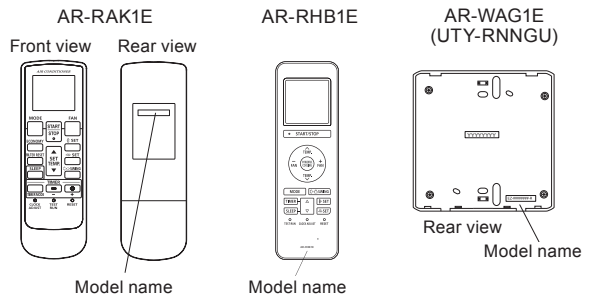

(4) Unused SW

SET2-2 to 3: Not used
Factory settings: "OFF"

(5) Remote controller 2WIRE/3WIRE switching SW (SET3)

"Factory setting: 2WIRE"

Match with the setting of the used indoor unit.

Set matched with the connection method of the remote controller cable to be connected.

9. TURNING ON THE POWER

- (1) Check the network convertor wiring and switch settings on the circuit board.
- (2) Check the wiring and switch settings for the VRF system and multi system or single model. For the wiring and switch settings method, refer to the installation instruction sheet of each unit.
- (3) Turn on the power for the VRF system and multi system or single model.
- (4) Power will be supplied from the system to the convertor.
 - Network convertor will be initialized and the power turned on. LED1 (green) and LED2 (orange) will flash.
 - After initial setting is completed, operation will be restarted automatically. LED1 (green) lights.
 - Network convertor does not operate during initialization.
 - * An error code will appear on LED in the event of a malfunction.

10. LED DISPLAY

10.1. Normal code

Normal indications			Normal contents
LED1 (green)	LED2 (orange)	LED3 (red)	
●	●	□	During initialization (during initialization sequence)
■	□	□	Normally operating

- Display mode
- : On
 - : Off
 - : Flashing

10.2. Error code

When error occurs in the remote controller connected to the Network convertor, please refer to the installation manual of the remote controller and indoor unit.

Error indications			Error contents
LED1 (green)	LED2 (orange)	LED3 (red)	
● (1)	● (2)	◇	Remote controller communication error
● (1)	● (5)	◇	Scan error
● (1)	● (6)	◇	Peripheral unit communication error
● (2)	● (6)	◇	Indoor unit address setting error
● (11)	● (2)	◇	Peripheral unit transmission PCB error

- Display mode
- : 0.5s ON / 0.5s OFF
 - ◇ : 0.1s ON / 0.1s OFF
 - () : Number of flashing

* LONWORKS® is registered trademark of Echelon Corporation in the United States and other countries.