

Premium+

Hydraulic pilot for heat pumps



Installation manual

PREMIUM+
pilot for heat pump
Ref. 753020



The information contained in this document is non-contractual. We reserve the right to modify the technical specifications or characteristics of any of our appliances without prior notice.



BV Cert. 6020118*

**Made in
France**



Manual ref: 1898019

Edition n°: 22.30

* Concerns the HTI⁷⁰ 6 & 8 single-phase models

TABLE OF CONTENTS

1 - SAFETY	3	5 - SET-UP	14
2 - PLEASE READ IMMEDIATELY	5	5.1 - Before set-up.....	14
2.1 - Conservation of documents	5	5.2 - Check watertightness.....	14
2.2 - Symbols used	5	5.3 - Starting set-up	14
2.3 - Abbreviations and acronyms.....	5	5.4 - Step 1: Circuit choice	14
2.4 - Delivery terms and conditions.....	5	5.5 - Step 2: Filling	14
2.5 - Storage and transport.....	5	5.6 - Step 3: Purging the installation	15
2.6 - Unpacking.....	5	5.7 - Step 4: Choosing the back-up	15
2.7 - Rating plate.....	5	5.8 - Step 5: Finishing set-up	15
2.8 - End of life of the appliance.....	5	5.9 - 1st use.....	15
3 - INTRODUCTION	6	6 - SETTINGS AND FUNCTIONS	16
3.1 - General information	6	6.1 - Control panel.....	16
3.2 - Packaging	6	6.1.1 - Keypad.....	16
3.3 - Accessories (included)	6	6.1.2 - Display.....	16
3.4 - Accessories available as optional extras.....	6	6.2 - Menus	17
3.4.1 - Installation	6	6.3 - Actions to be activated using a combination of buttons....	17
3.4.2 - Control.....	6	6.4 - List of parameters which can be set	18
3.5 - Operating principles.....	7	6.5 - Description of functionalities	21
4 - INSTALLATION.....	7	6.5.1 - Functions related to heating.....	21
4.1 - Placement choice.....	7	6.5.1.1 - AUTO temperature (heat curve)	21
4.1.1 - Appropriate placement choice.....	7	6.5.1.2 - Lowering of the temperature	21
4.1.2 - Integration	7	6.5.1.3 - Auto-adaptability.....	21
4.2 - Hydraulic installation.....	8	6.5.1.4 - Ambient temperature reactivity.....	21
4.2.1 - Recommendations.....	8	6.5.2 - Programming and timeout functions.....	21
4.2.1.1 - Backflow prevention device.....	8	6.5.2.1 - Anticipation of return from holiday	21
4.2.1.2 - Cross sections, purging of the heating circuits.....	8	6.5.2.2 - Automatic summer/winter changeover.....	22
4.2.1.3 - Desludging tank.....	8	6.5.3 - Ambient temperature and heating circulation control functions.....	22
4.2.1.4 - Preparing the hydraulic circuit (rinsing).....	8	6.5.3.1 - Ambient temperature sensor hysteresis.....	22
4.2.1.5 - Expansion vessel	8	6.5.3.2 - Circulator pump speed	22
4.2.1.6 - Frost protection.....	8	6.5.3.3 - Heating circulator control.....	22
4.2.1.7 - Underfloor heating.....	8	6.5.3.4 - Anti-cold radiators.....	22
4.2.1.8 - Thermostatic valves.....	9	6.5.4 - Functions related to the production of domestic hot water	22
4.2.1.9 - Treatment of the water in the heating circuit.....	9	6.5.4.1 - Domestic priority sharing	22
4.2.1.9.1 - Filling water.....	9	6.5.4.2 - Anti-legionellosis protection.....	22
4.2.1.9.2 - Treatment of the heating circuit.....	9	6.6 - Heat pump circulator speed	22
4.2.1.9.3 - Purging the installation	9	7 - MAINTENANCE AND TROUBLESHOOTING...22	
4.2.1.9.4 - Connecting the pressure relief valve.....	9	7.1 - Maintenance	23
4.2.2 - Hydraulic connections.....	10	7.2- Diagnostics.....	23
4.3 - Electrical connections	10	7.2.1 - Loading the operating history.....	23
4.4 - Connection to the Heat pump and to the accessories for control.....	11	7.2.2 - Consulting the current operating state of the system.....	23
4.4.1 - Control connection towards the Heat pump	12	7.2.3 - Water sensors	24
4.4.2 - Ambient temperature control.....	12	7.2.4 - Exterior sensor	24
4.4.3 - Exterior sensor	12	7.2.5 - Consulting the counters.....	24
4.4.4 - Domestic water sensor	12	7.2.6 - Manual forcing of components.....	24
4.4.5 - Connecting to a back-up boiler	12	7.2.6.1 - Circulator pump	24
4.4.6 - Underfloor safety device of the 65°C safety aquastat (OPT) with manual reset (OPT)	13	7.2.6.2 - Electrical back-up.....	24
4.4.7 - Electrical power connection.....	13	7.2.6.3 - Back-up boiler	24
		7.2.7 - Errors indicated by the pilot	25

1-SAFETY

8 - SPARE PARTS 29

8.1 - PREMIUM+ pilot29

9 - WARRANTY 30

9.1 - Warranty coverage30

9.2 - Limitations of warranty.....30

9.2.1 - General information30

9.2.2 - Cases (not limited to) for exclusion from warranty30

9.2.2.1 - Usages.....30

9.2.2.2 - Handling.....30

9.2.2.3 - Installation site.....30

9.2.2.4 - Electrical connections30

9.2.2.5 - Hydraulic connections30

9.2.2.6 - Accessories30

9.2.2.7 - Maintenance.....30

APPENDIX 31

A1 - Technical specifications.....31

A1.1 - General characteristics31

A1.2 - EU declaration31

A1.3 - Dimensions.....32

A2 - Hydraulic schematic diagrams33

A2.1 - 1 radiators circuit33

A2.2 - 1 underfloor heating circuit34

A2.3 - 2 radiators circuits.....35

A2.4 - 2 underfloor heating circuits36

A2.5 - 1 radiators circuit + 1 DHW circuit37

A2.6 - 2 radiators circuits + 1 underfloor heating circuit.....38

A2.7 - 1 DHW circuit + 1 radiators circuit + 1 underfloor heating circuit39

A2.8 - Hydraulic connection between the pilot and the heat pump.....40

A2.9 - Minimum flow rate to respect depending on the heat pump model.40

A3 - Wiring diagrams.....41

A3.1 - PREMIUM+ pilot: wiring diagram with electrical back-up
or boiler back-up41

A4 - Recap of functions42

A4.1 - Control panel.....42

A4.1.1 - Keypad.....42

A4.1.2 - Display.....42

A4.2 - Menus.....43

A4.3- Actions to be activated using a combination of buttons43

Danger resulting from improper qualifications

- Any work carried out by an unqualified person can result in damage to the installation or in physical injury.
- Do not perform maintenance on this appliance unless you are a qualified professional.
- If the appliance is malfunctioning or not working, cut the electricity supply to the electrical components and seek advice from a qualified professional.

Danger resulting from improper use

This appliance should not be used by anyone (including children under the age of 8 years old) with reduced physical, sensory or mental capabilities, or by anyone with insufficient experience or knowledge of the appliance; unless they are being supervised by someone who is responsible for their safety and in possession of the operating instructions of the appliance, or if they have been instructed in the proper use and in the risks of operating the appliance.

Children must not play with the appliance. Cleaning and maintenance of the appliance must not be undertaken by children without supervision.

Applicable areas of use

The appliance is intended for use as an appliance for the production of domestic hot water: it must be connected to a heating installation, and while complying with the instructions, connected to the drinking water network.

The intended use of the appliance includes the following points:

- Following the instructions for operating, installing and maintaining this appliance and all of its components.
- Ensuring the compliance of the appliance to all inspection and maintenance conditions which are listed in this manual.

Danger of death by electrocution

- Touching live electrical wires can cause severe bodily injury, and lead to death by electrocution. All installation and maintenance work must be carried out with the appliance switched off and by a qualified professional. Before carrying out any work on the appliance:

- Cut-off the electricity supply.
- Ensure that there is no possibility of the power supply becoming active again.
- Wait at least 5 minutes for the capacitors to lose their charge.

- Do not get water on any of the control or electrical components. Always disconnect the appliance from the electricity supply before carrying out work on any of the electrical components.

Danger of death if the pressure relief valves are missing or defective

A defective pressure relief valve may prove dangerous and could lead to burns or other injuries by, for example, the pipes bursting.

The information presented in this document does not contain all of the schematic diagrams needed for a professional installation of the pressure relief valves.

- Install the necessary pressure relief valves on the circuit.
- Inform the user concerning the function and the placement of the pressure relief valves.
- Respect all applicable national and international regulations, standards and decrees.

Risk of corrosion

The appliance should be installed in an area where it is not exposed to humidity and without any risk of being splashed by water.

Risk of damage related to frost

The pilot **MUST** be installed in an area where it is not subject to frost or freezing.

Risk of material damage

The pilot can only work when filled with water. Never switch on the appliance if it is not completely filled with water and purged of air.

Rules and regulations (decrees, standards, laws)

Once the appliance is installed and switched on, all decrees, directives, technical rules, safety measures and standards, must be respected in their current version in effect.

The electrical supply must conform to all applicable regulations in the country of installation, as well as the NFC 15-100 standard.

- A method of disconnection ensuring a complete cut-off must be installed in the fixed piping to conform to installation regulations (do not use a movable outlet).
- Protect the appliance with a 2-pole circuit breaker with a minimum contact opening of 3mm and must be grounded.
- If the electrical supply cable is damaged, it must be replaced by the manufacturer, their customer service technicians, or by a qualified professional to prevent any risk of injury or danger.
- The devices for electrical cut-off must remain accessible.
- Water and/or R290 flammable gas can flow through the discharge pipe of the pressure limiting device (safety valve). This pipe must be kept open outside the building. The end of this pipe must be placed downwards (see § Connecting the pressure relief valve).

Maintenance - Troubleshooting

Maintenance and cleaning of the pilot must be carried out at least once a year by a qualified professional.

This appliance is in compliance with the international standards concerning electrical safety CEI 60335-1, CEI 60335-2-102. The CE branding on the appliance attests to its compliance with the following directives:

- **Low voltage (LV): 2014/35/UE**
- **Electromagnetic compatibility(CEM): 2014/125/CE**
- **Ecodesign concerning products related to energy: 2013-813-UE**

2 - PLEASE READ IMMEDIATELY

This technical installation manual forms part of the appliance which it refers to. In order for the warranty to be valid, the instructions must be read prior to using the appliance.

The safety advice and instructions provided in this manual must be strictly respected.

Our society is not liable for any damages caused from not following the instructions provided, or improper handling, installation or use.

This technical installation manual can be modified without prior notice.

2.1 - Conservation of documents

This manual must be safeguarded and passed on to successive users for future reference.

It will be considered as evidence in case of litigation.

2.2 - Symbols used



Indicates warnings and important recommendations.



Consult the installation manual before any intervention on the product, before handling, installation, use, and maintenance.



Contains regulated substances, do not throw in the garbage. If disposing, please respect all regulations pertaining to the recovery of electric and electronic equipment.



Indicates the maximum water temperature in operation.



Heat power output produced.

PS max Maximum working pressure.

2.3 - Abbreviations and acronyms

DHW Domestic Hot Water

DCW Domestic Cold Water

T° Temperature

HP Heat pump

2.4 - Delivery terms and conditions

In general, the material is transported at the recipient's own risk.

It is important to ensure that all components have been received and that no damage has been sustained during transport upon receipt of the appliance, and before beginning the installation procedures

2.5 - Storage and transport

Admissible storage and transport temperatures are from -20°C to +60°C.

The **Pilot** must be stored and transported in its original cardboard packaging and empty of water and transported horizontally.

2.6 - Unpacking

On reception of the **Pilot**, check the state of the cardboard packaging as well as the general state of the product, and remove it from its cardboard box.

Opening the front panel of the **Pilot** allows you to access the box of included accessories as well as the electrical terminal for connection to the electrical supply and to the different control components.

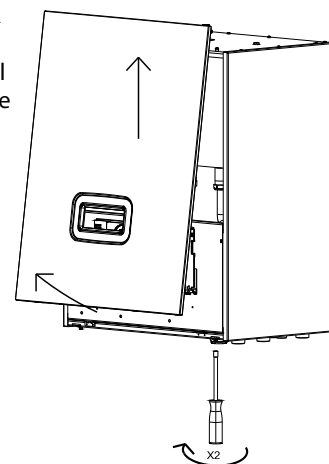

1- To remove the front panel, unscrew the two TH7 screws which are located on both sides underneath the **Pilot**.

2- Pull the base of the front panel forwards, and lift the panel to unhook the pegs located at the top of the **Pilot**.

To replace the front panel, rehook the pegs in place at the top of the **Pilot**, replace the panel back into position and screw the two TH7 screws back in.

2.7 - Rating plate

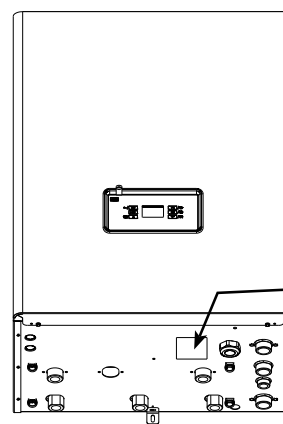

2.8 - End of life of the appliance



Our products are designed and manufactured using components made of recyclable materials.

The appliance must never, in any case, be disposed of with household waste, or in a dump.

The dismantling and recycling of the appliances must be taken charge of by a qualified professional and in compliance with all local and national standards in effect.

3 - INTRODUCTION

3.1 - General information

The **Pilot** is a hydraulic pilot which ensures the control of one or more heating circuits (with options).

The **Pilot** is meant to be connected to an **HRC**⁷⁰ or **HTI**⁷⁰ range heat pump.

Equipments	
Integrated electric heater for back-up	0 to 6 kW
Multifunctional tank ensuring the uncoupling of the hydraulic circuits	38 litres
Electronic control taking charge of the optimal management of the installation	•
Essential components for the protection of the hydraulic circuits (pressure relief valves, automatic purgers, pressure sensors)	•
Scheduled programming of the comfort mode for the 7 days of the week using programmable ranges	•

The **Pilot** is delivered ready to use in its factory set configuration (see § «Set-up»)..

However, we strongly recommended the use of the «Start-up» function proposed at the first powering of pilot. It allows for use to be personalised for the household.

This configuration and its settings can be modified in the expert menu.

3.2 - Packaging

	Weight (kg)	Number of packages	W (mm)	H (mm)	P (mm)
Premium+	54	1	670	600	880

3.3 - Accessories (included)

Each **Pilot** is delivered with (non-mounted):

- **Exterior sensor**

Gives the pilot the outside temperature to adapt its heating set point



- **USB memory stick**

Allows downloading of the operating history



Be sure to keep the original delivered USB flash drive. It will facilitate your exchanges with your technical contacts.

- **Wall mounting bracket**

Eases the installation on the wall.

3.4 - Accessories available as optional extras

3.4.1 - Installation

- **2nd heating circuit**

2nd heating circuit at the same temperature
Allows distribution of a second heating circuit controlled by a thermostat (TA) (**Ref. 753105**)

3.4.2 - Control

- **Ambient temperature thermostat (TA)**

2 wires - allows to control the temperature in the heating zone
(**Ref. 710043**)



- **Ambient temperature sensor (SA)**

2 wires - allows to control the temperature of the heating zone on a variety of comfort levels (programmable from the pilot).
(**Ref. 751009**)



- **Ambient temperature thermostat radio non-chronoproportional -(TH^{Rnc})-**

(type on/off). Wireless, programmable thermostat, transmitting through radio-frequency. Necessary when a wired connection between the Pilot and the ambient temperature thermostat is not possible
(**Ref. 770001**)

- **2-core sheathed cable (Ref. 753102) linking the Heat Pump and the Pilot (20m long)**

20m length for connection instead of the 10m length delivered as standard.

- **DHW sensor**

For the production of domestic hot water
(**Ref. 710029**)

3.5 - Operating principles

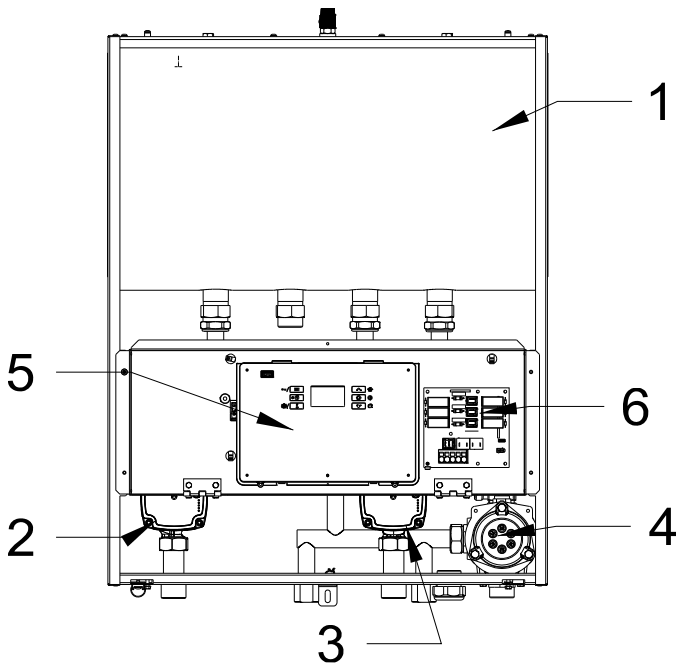

- | | |
|-----------------------------------|------------------------------|
| 1. 38L buffer tank | 6. Power board |
| 2. Circulator for heat pump | 7. Heating circuit |
| 3. Circulator for heating circuit | 8. Drain |
| 4. Electrical heater | 9. Back-up boiler (optional) |
| 5. Electronic controller | 10. Heat pump |

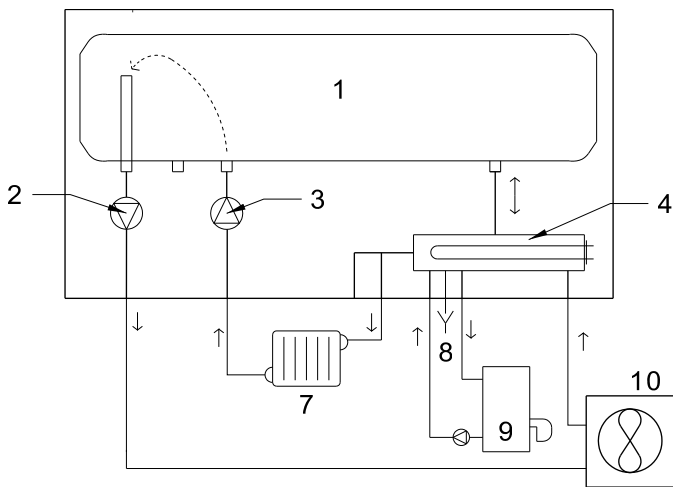

4 - INSTALLATION

4.1 - Placement choice

4.1.1 - Appropriate placement choice



The Pilot must be installed on a level and stable base which is distanced from appliances used for cooking and other heat sources.

The **Pilot** must be placed in an area which is free from frost and adverse weather conditions.

It must be placed as close to the heat pump as possible without exceeding the maximum distance.

The maximum distance depends on the diameter of piping and the number of elbows used (see «Hydraulic connection» tables).

The 2-core sheathed cable which connects the **Pilot** and the heat pump measures 10m. There is a 20m length available as an optional extra (Ref. 753102).

4.1.2 - Integration

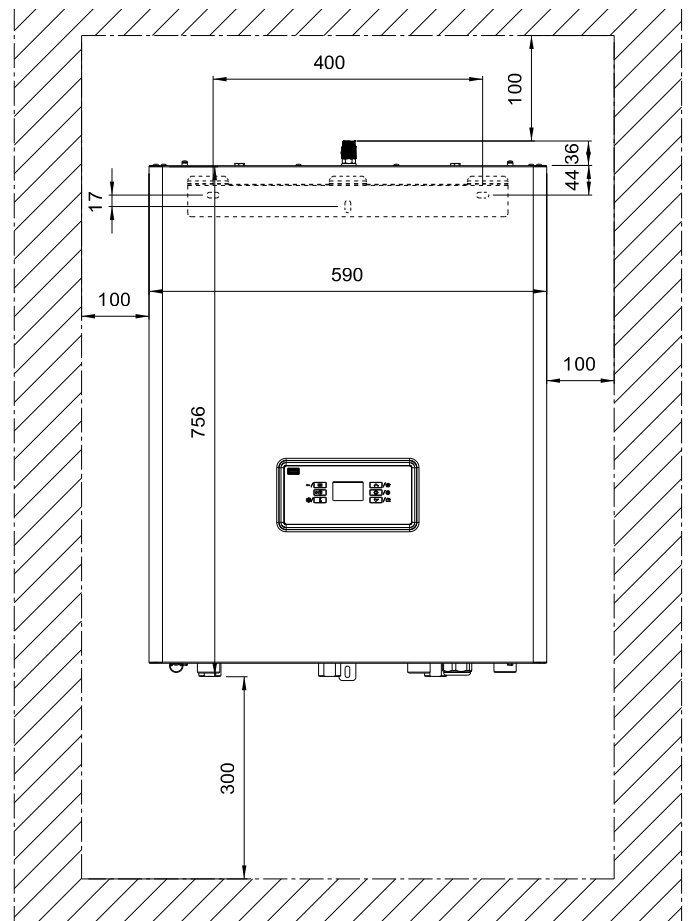

Place and fix the mounting bracket on the wall first.

Then hang the pilot on the bracket using its tabs.

4.2 - Hydraulic installation

Consult the hydraulic schematic diagrams in the appendix.

4.2.1 - Recommendations

4.2.1.1 - Backflow prevention device

A type CB backflow prevention device may be installed. This device must be at different, non-regulated pressure zones. Check your national laws and regulations to know if this is an obligatory requirement. The backflow prevention device is designed to prevent incoming heating water from entering the drinking water circuit. It must be connected to the mains drainage system.

4.2.1.2 - Cross sections, purging of the heating circuits

A sufficient flow rate should be ensured so that the difference in temperature between the outlet and inlet points does not exceed 6°C. In an installation equipped with thermostatic mixing valves, this inspection must be done with all taps/valves open.

The output actually needed determines the water flow rate of the heating circuit and allows to calculate the dimensions of the distribution network.

Adapt the speed of the circulator pump to the hydraulic characteristics using the flow rate/pressure curve provided.

All necessary measures must be taken to ensure that the installation can be continuously purged. Automatic air purging valves should be placed at each high point of the installation, and manual air purging valves should be installed on each radiator.

4.2.1.3 - Desludging tank

Plan for a desludging tank with a sufficient volume at a low point on the inlet of the heating circuit. This tank must be equipped with a drain so it can collect the oxides, particles, and calamines which detach from the inner walls of the heating circuit while it is in operation.

4.2.1.4 - Preparing the hydraulic circuit (rinsing)

Before placing the pilot and heat pump, it is necessary to rinse the installation with an appropriate product. This allows to eliminate all traces of soldering waste, joint filler, grease, sludge, metallic particles, etc... in the radiators, underfloor heating, etc...

The installation must be equipped with an expansion vessel. Its capacity must be sufficient.

4.2.1.5 - Expansion vessel

The installation must be equipped with an expansion vessel with a sufficient capacity (which depends on the static height of the installation, the blowing-up pressure of the expansion vessel and the volume of the installation)

4.2.1.6 - Frost protection

Frost protection is necessary if the pilot is switched off during the winter months (ex: secondary residence, etc...).



If the appliance is connected to an electricity supply, the heating circuit is protected from freezing. It is IMPERATIVE to drain the domestic hot water circuit however.

If the pilot is not being supplied with electricity (electrical cut-off for example), or it is defective and there is a risk of freezing, it is IMPERATIVE to completely drain the appliance (heating and hot water).

4.2.1.7 - Underfloor heating

It is mandatory to install a 65°C safety aquastat (OPT) with manual reset (OPT) on the underfloor heating outlet.

CAUTION WHEN THE INSTALLATION INCLUDES A SANITARY TANK !

1. The DHW setpoint setting must be less than 55 ° C.

2. Place the safety aquastat as close as possible to the common outlet of all the underfloor heating loops (that is to say just upstream of the floor outlet manifold) so as to move it away from the Pilot's floor outlet outlet and in order to avoid its triggering after a load of the domestic hot water tank.

4.2.1.8 - Thermostatic valves

Thermostatic valves: these valves should prioritise rooms with higher levels of heat gain.



In an installation with both thermostatic valves and a room temperature thermostat, the radiator(s) in the room in which the thermostat is located MUST be equipped with a manual valve(s).



It is IMPERATIVE to refer to the installation instructions for the initial installation of the ambient temperature thermostat to ensure satisfactory operation.

4.2.1.9 - Treatment of the water in the heating circuit



It is MANDATORY to read the additional document concerning the quality of water used for filling the installation. This document is included with this manual as well as in the packet with the warranty information.

This document also contains information which is PERTINENT to the WARRANTY of the material.

4.2.1.9.1 - Filling water

The materials used for producing a heating circuit are of different natures. Instances of corrosion may occur through galvanic coupling in both new and existing installations.

The filling of the heating circuit must only be done with untreated water (no water softener) from the drinking water network. Water from any other source (rain-water, well-water, etc...), must be analysed and **MUST** have the following properties:

8,5	≤	PH (acidity)	≤	9,5
		Chlorides	≤	60 mg / litre
		Conductivity	<	1000 µS / cm
5	≤	TH (hardness in French °)	≤	15



Central heating installations must be cleaned in order to eliminate debris (copper, filings, soldering waste) related to the set-up of the installation or from chemical reactions between the metals.

Futhermore, it is important to **protect the central heating installations from risks of corrosion, limescale, and microbiological development** through use of a corrosion inhibitor which is suitable for all kinds of installations (steel or cast-iron radiators, PEX underfloor heating).

PRODUCTS USED FOR HEATING WATER TREATMENT MUST BE APPROVED BY THE LOCAL OR NATIONAL PUBLIC HYGIENE AND HEALTH AUTHORITY.

4.2.1.9.2 - Treatment of the heating circuit

We recommend the use of products in the **SENTINEL** range by **GE BETZ** for preventative and curative treatment of the heating circuit.

• For new installations : (less than 6 months old):

- Clean the installation with a universal cleaner to eliminate the debris from the installation (copper, fibres, soldering fluxes) Example : **SENTINEL X300**
- Thoroughly rinse the installation until the water runs clear, with no traces of impurities left.
- Protect the installation against corrosion with a corrosion inhibitor, example: **SENTINEL X100**. Or against corrosion and freezing with an inhibitor with an anti-freeze additive. Example : **SENTINEL X500**.

• For existing installations:

- Desludge the installation with a desludging product to eliminate any sludge from the installation. Example: **SENTINEL X400**.
- Thoroughly rinse the installation until the water runs clear, with no traces of impurities left.
- Protect the installation against corrosion with a corrosion inhibitor, example: **SENTINEL X100**. Or against corrosion and freezing with an inhibitor with an anti-freeze additive. Example : **SENTINEL X500**.

Corrosion inhibitor :

- protects against the formation of limescale
- prevents «pinhole» type corrosion
- prevents, in new installations, the formation of sludge and the proliferation of bacteria (in low temperature networks: algae)
- prevents the formation of hydrogen
- eliminates the sound of the generators

Treatment products from other manufacturers can be used if they guarantee that the product is appropriate for all the materials used in the appliance and offers efficient resistance to corrosion. To find this information refer to their user manual.

4.2.1.9.3 - Purging the installation

The oxygen present in the air is extremely corrosive. All necessary measures must be taken to ensure that the installation can be continuously purged. Automatic air purging valves should be placed at each high point of the installation, and manual air purging valves should be installed on each radiator.



RENDERING THE WARRANTY NULL AND VOID

Any deterioration of the appliance due to inappropriate filling water, and/or corrosion in the absence of the use of treatment products, and/or improper purging of the installation, will render the warranty null and void.

4.2.1.9.4 - Connecting the pressure relief valve

The Heat Pump and the **Pilot** are both equipped with pressure-relief valves. The **Pilot's** pressure-relief valve is set at 3 bars.

The pressure-relief valve on the Heat Pump sets the maximum acceptable pressure in the installation (2.5 bars when hot). The maximum service pressure in the Heat Pump must, consequently, be lower than 2.5 bars.

*Example : If the Heat Pump is positioned 5m below the **Pilot**, the pressure reading on the **Pilot** would be 0.5 bars less than the real pressure of the water in the Heat Pump. In this case, the maximum service pressure for the **Pilot** would be 2 bars.*

Therefore it would be advisable to fill the heating circuit at an intermediary pressure (between 1 and 1.5 bars).

For safety reasons (potential presence of flammable R290 gas), drainage of the Pilot's pressure-relief valve must **MANDATORILY** be done **outside the building**. The outlet of the drainage pipe (4m length provided with the pilot) must be placed downwards in order to avoid any introduction of water inside, any risk of obstruction due to frozen water or any other pollution (see drawing).

If the provided drainage pipe is too short, it's mandatory to use a well-adapted length (can be supplied on demand). It will have to be installed as well as there will be no pinch on it, it will then ensure the drainage of the overpressure from the 3 bar safety valve outside the building.



The Pilot's pressure-relief valve drainage pipe must be properly secured until the outside of the building without any pinching zone.



WARNING

Failure to comply with this requirement concerning the evacuation of overpressure outside the building releases the heat pump manufacturer from any liability in case of incident.

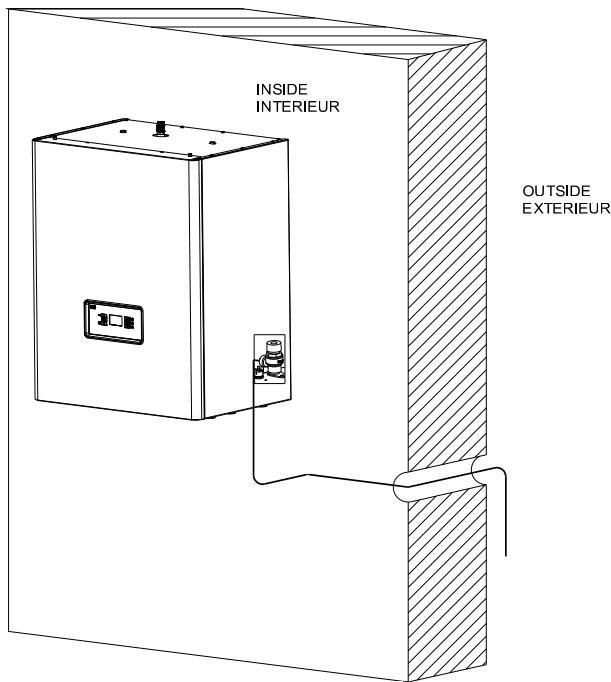

! The EPDM pipe must be pushed to the end of the safety valve barb tip and held with a hose clamp.

1. EPDM pipe

2. Hose clamp

4.2.2 - Hydraulic connections

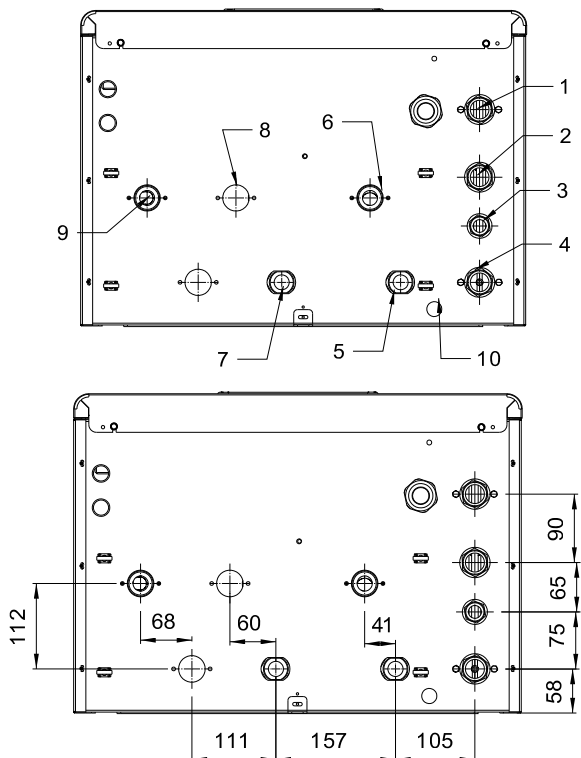

	Description	Hydraulic connections
1	Inlet from heat pump	1"
2	Outlet towards boiler	1"
3	Drain	3/4"
4	Inlet from boiler	1"
5	Outlet towards heating circuit 1	1"
6	Inlet from heating circuit 1	1"
7	Outlet towards 2nd heating circuit (optional)	1"
8	Inlet from 2nd heating circuit (optional)	1"
9	Outlet towards heat pump	1"
10	Safety valve outlet	-

4.3 - Electrical connections

Plan for a circuit breaker dedicated to the power supply of the **Pilot** on the electrical panel. It must be able to completely cut-off the electrical supply from the network (all-pole) to eliminate any danger when carrying out maintenance on the appliance.

How to proceed:

- Check that the «ground» cable is connected properly to the grounding peg or grounding network of the building.
- Connect the **Pilot's** electrical cable to the dedicated plug, equipped with a circuit breaker.
- Leave the pilot switched off until set-up.
- If a back-up boiler has to be connected ensure it is powered off before any action.

The proper voltage is: 230 V (+10% / -15%) single phase or 400V in the case of a three phase connection. Each appliance is delivered from the factory completely pre-wired. However, it is necessary to connect the following elements to the relevant terminals:

- The general electricity supply.
- The different sensors or thermostats on the **Pilot**.
- The 2-core shielded cable connecting the **Pilot** and the Heat pump (10m length supplied).
- The back-up boiler (optional)

For three phase 400V electrical connection, refer to § «Electrical Power Connection»

Under no circumstances will the manufacturer be held liable for any problems which may arise due to improper installation and/or choice of power supply cable.



The rules and regulations in the country of installation MUST be respected (standard C15-100).

- The electrical lines for general power supply to the circuits must be made in compliance with your country's current rules and regulations (standard C15-100).
- Standard C15-100 determines the cable section to be used based on acceptable currents.
- Standard C15-100 determines the cable section to be used based on the following elements :
 - Nature of the conductor :
 - . type of insulation, number of strands, etc...
 - Installation mode :
 - . influence of conductor and cable groups
 - . ambient temperature
 - . tightly or non-tightly installed
 - . length of cables, etc...

4.4 - Connection to the Heat pump and to the accessories for control

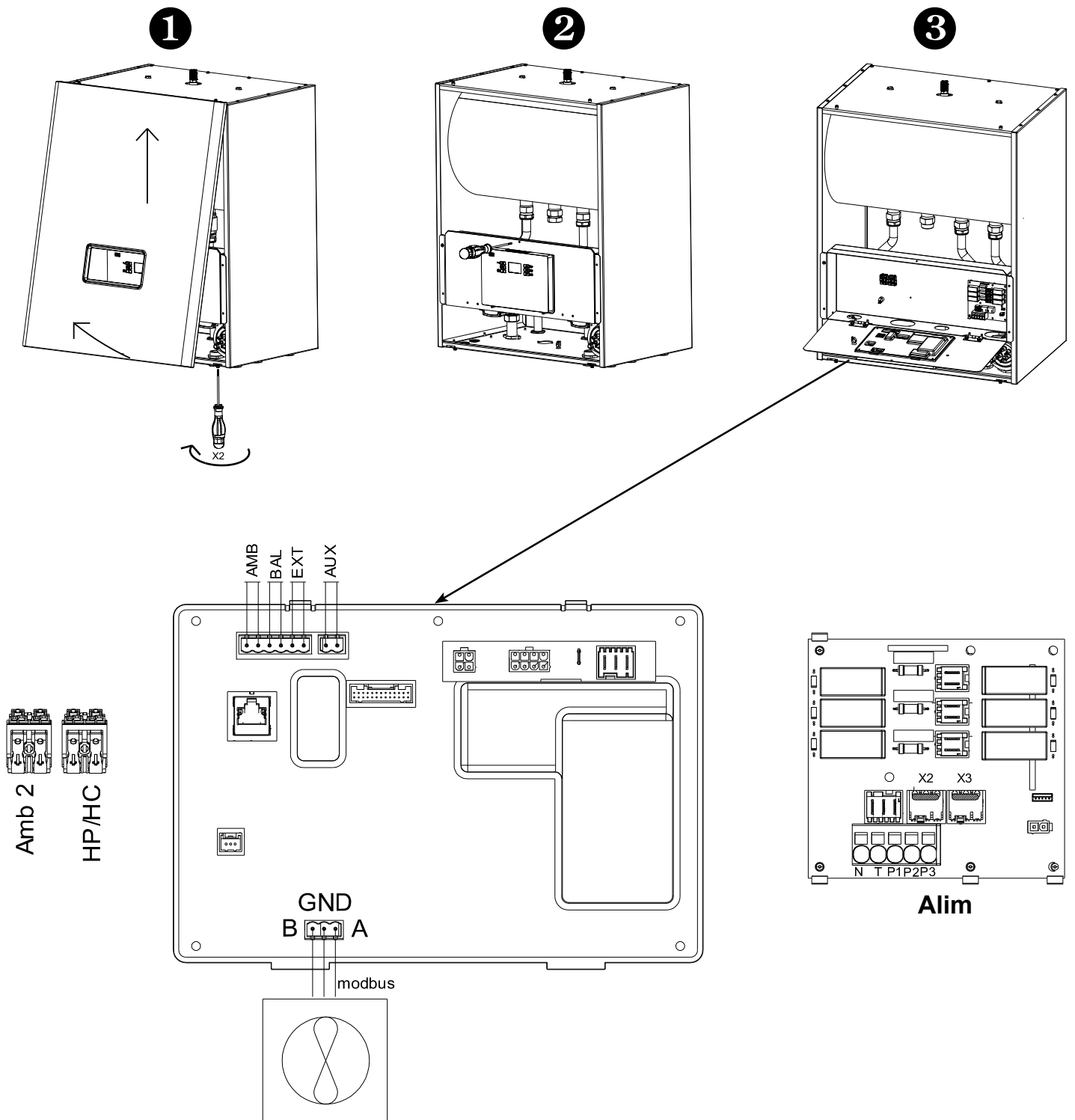

Alim : Main power terminal block
Amb : Ambient temperature sensor or thermostat (dry contact)
Amb 2 : Thermostat (dry contact) for circuit 2
Aux : Auxilliary boiler (back-up)

Bal : Tank sensor
Ext : Exterior sensor
HP/HC : Peak hours/ off-peak hours contact
ModBus : Connection to the heat pump

4.4.1 - Control connection towards the Heat pump

- Connect the two wires of the connecting cable on terminals **A** and **B** of the «**Modbus**» terminal while taking care to respect the polarity **A/B** (terminal **A** of the **Pilot** to be connected to terminal **A** of the heat pump; the same for terminal **B**).
- Connect:
 - the brown wire to A
 - the white wire to B
 - the black wire to GND on both appliances.
- If you are using a different cable, respect the polarity of A and B as well as the connection of the shielding on 0V on both appliances.

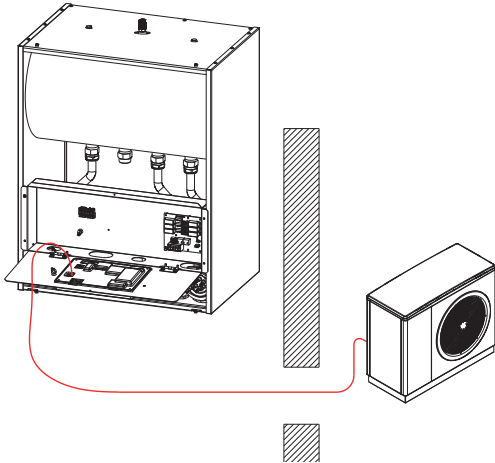

Plan for the appropriate length of cable between the pilot and the heat pump. Do not hesitate to cut the cable to the appropriate length to **AVOID LOOPS**.



Ensure that the connecting cable is distanced from any source of electrical disturbance (ex: washing machine, neon lighting, power supply cable....)

4.4.2 - Ambient temperature control

In an installation with both thermostatic valves and a room temperature thermostat, the radiator(s) in the room in which the thermostat is located **MUST** be equipped with a manual valve(s).

It is mandatory to install the ambient temperature control on an interior wall of the room and not a wall that lets out onto the outside of the building.

Installation against an exterior facing wall is prohibited.

Do not place the ambient temperature controller too close to a window, a curtain, or a door. Avoid placing it in an alcove, a closet, or behind drapes.

Do not place above a heat source (radiator,...) or against a wall with a chimney.

Do not place in reach of sun's rays, or near powerful lighting.

Place the sensor 1.50m above floor level, and at least 50cm away from neighboring walls. Insulate the extremities of the electrical cabling of the installation on the side of the appliance to prevent air currents from influencing the measures taken.



EXCLUSIVELY connect either:

- The **AMBIENT TEMPERATURE SENSOR with DISPLAY (Ref. 751009)**
- The **AMBIENT TEMPERATURE RADIO THERMOSTAT (Ref. 770001)**

All other thermostats which are chronoproportional may cause malfunctioning and render the warranty null and void.

4.4.3 - Exterior sensor

The connection of the exterior sensor is recommended (if it is not the heat curve is calculated using the temperature read by the air sensor).

Place the sensor on the coldest exterior wall of the building (usually the north-facing wall). It must not be exposed to the morning sun.

It is preferred to mount the exterior sensor in the middle of the wall of the building or of the heating zone, at least 2.5m above ground level.

Do not place the sensor:

- above windows, doors, air exhausts, or other heat sources,
- beneath balconies or gutters

To prevent mistakes in the temperatures measured due to air circulation, insulate the extremities of the sensor's electrical conduit.

Do not paint the exterior sensor.

Note :

After connection, go to the «*DISPLAY*» menu and check that the «*EXTERIOR*» screen appears with the value read by the probe. If not, check the connection of the probe or the pilot connector.

4.4.4 - Domestic water sensor



EXCLUSIVELY connect the water sensor (Ref. 710029).

If DHW is produced by a domestic hot water tank:

- Place the sensor in the well of the tank to inspect the temperature of the hot water immediately available.
- Connect the water sensor to the «**BAL**» terminals of the **Pilot**.

4.4.5 - Connecting to a back-up boiler

Access to the terminal block :

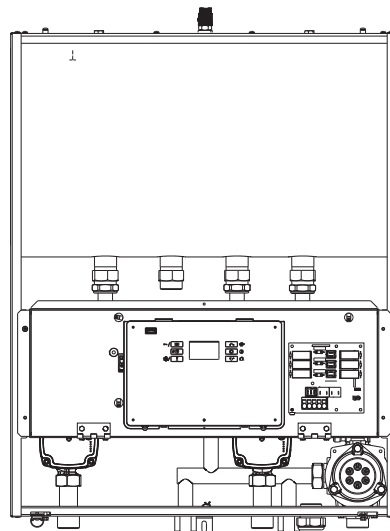

Connect according to the wiring diagram (in appendix) of the **PREMIUM+** driver with the boiler booster.

4.4.6 - Underfloor safety device of the 65°C safety aquastat (OPT) with manual reset (OPT)

Use the additional wiring provided in the kit (*Ref. 710111*) to protect the floor heating circuit.

CAUTION WHEN THE INSTALLATION INCLUDES A SANITARY TANK !

1. The DHW setpoint setting must be less than 55 ° C.

2. Place the safety aquastat as close as possible to the common outlet of all the underfloor heating loops (that is to say just upstream of the floor outlet manifold) so as to move it away from the Pilot's floor outlet outlet and in order to avoid its triggering after a load of the domestic hot water tank.

4.4.7 - Electrical power connection

Single phase power supply :

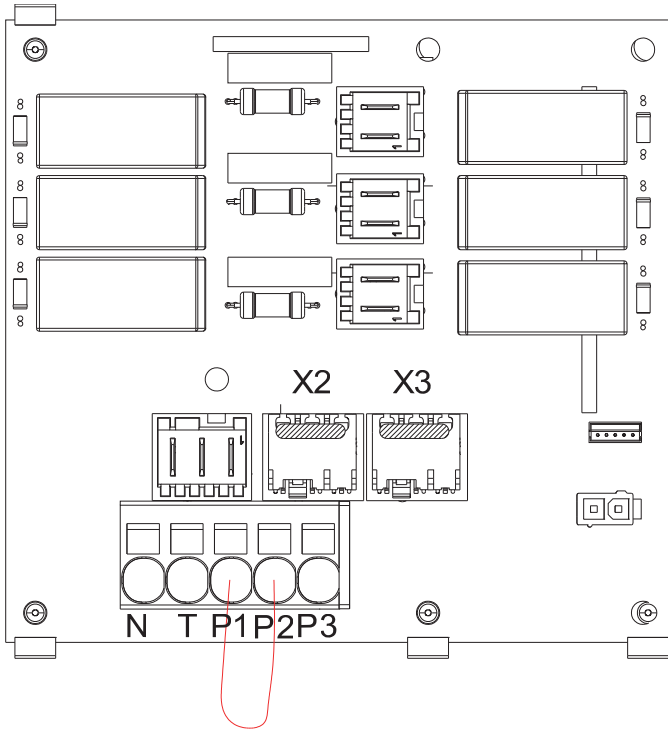

- Connect the power supply to the main terminal block on the power board.
- Make sure the phase is connected to the last terminal (marked P3).
- Ensure that the X2 and X3 connectors are equipped with phase distribution bridges.



The phase must be connected to terminal P3 and not to terminals P1 or P2.

Three phase power supply :

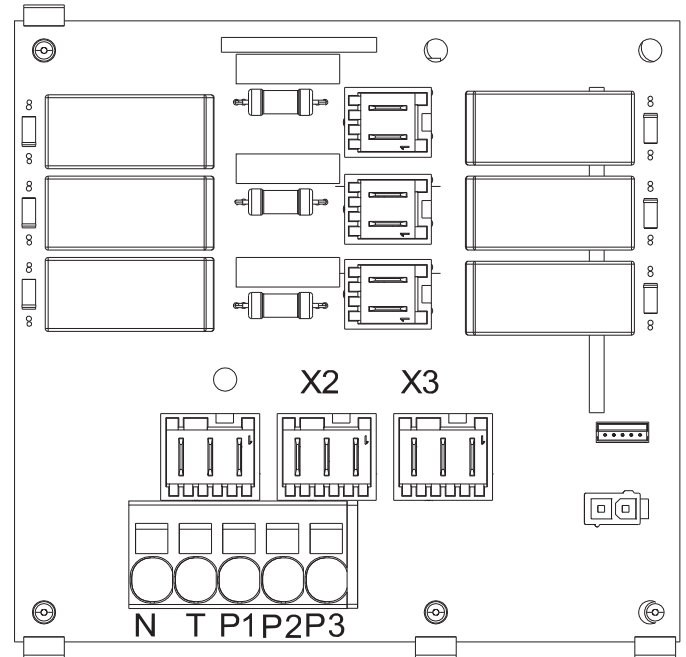

- Connect the power supply to the main terminal block on the power board. Each phase must be connected to one of the terminals P1, P2, P3 (remove the bridge between terminals P1 and P2).
- Remove the X2 and X3 connector bridges.



Do not power up without first checking that the connectors X2 and X3 and the bridge between terminals P1 and P2 have been removed.

5 - SET-UP



Set-up must be done by a qualified professional.

5.1 - Before set-up

Ensure that:

- All work carried out on the hydraulic circuits and the electrical circuits are in compliance with the regulations in effect (inspection by a qualified professional)
- The pressure relief valve on the cold water inlet of the domestic hot water tank is working properly and is properly connected to a drain in compliance with the regulations in effect.
- All piping is watertight.
- All hydraulic connections are properly tightened.
- The correct voltage at the mains switch.
- All of the valves are open and nothing is obstructing the circulation of water in the exchanger and in the hydraulic circuit.
- The installation is equipped with a filter valve or a filter on its inlet and that the filter is not clogged.
- The automatic air purger's cap is open.
- The exterior sensor and the ambient temperature control (if present on the installation) are connected properly.
- If using an ambient thermostat, ensure that it is actually being used and set to be on demand (turn it to its maximum set point).

Once all of these checks have been done, turn on the heat pump and the **Premium+ Pilot**.

5.2 - Check watertightness

Inspect the entirety of the hydraulic connections (nuts with washers, toric joints or anything assembled with glue) which may loosen during transport or during the installation process, and tighten if necessary.

After pressurising the appliance, it is important to check the watertightness (both visually and by any lowering of pressure) of all internal and external connections.



Any deterioration of the appliance due to a lack of watertightness renders the warranty null and void.

5.3 - Starting set-up



For optimal commissioning, make sure that all the required accessories (room control, decoupling kit, 2-circuit kit, etc...) are connected before starting the commissioning wizard. For room thermostats, make sure they are in demand for heating (sending a closed contact to the driver).



When the **Premium+ Pilot** is turned on for the first time, it will ask you to confirm the language of use (French, English, German, Italian, Spanish, or Polish), and will request to start set-up:



Choose **YES** and confirm by pressing .

NOTE: If you choose not to start set-up (**NO**) this option remains accessible in the expert menu, by the **COMMISSIO.** sub-menu.

5.4 - Step 1: Circuit choice

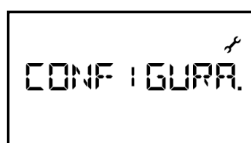

Select the kind of circuit connected (domestic hot water, radiators) and the associated control (sensor, thermostat).

NOTE: Circuits and controls are proposed according to the connected sensors.

5.5 - Step 2: Filling

Activate the backflow prevention device of the installation to fill the heating circuit to just over 1.5 bars of pressure.



During the filling stage, the **Premium+ Pilot** indicates the pressure measured in the heating circuit.

The **Premium+ Pilot** automatically confirms the filling of the installation once the pressure reaches 1.6 bars.

A manual confirmation (press ) is possible starting at 0.6 bars of pressure.

5.6 - Step 3: Purging the installation



The purging cycle activates the circulator pump at an alternating rhythm to allow the displacement and purging of any air bubbles accumulated at high points of the installation using the **Premium+ Pilot's** automatic purger.

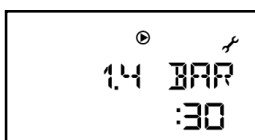

During the purging cycle, the screen indicates the countdown until the automatic stop of the cycle as well as the pressure in the circuit.



During the cycle, check that the automatic purgers are open and regularly activate the manual purgers.

If the pressure in the circuit becomes insufficient due to the volume of air purged, the **Premium+ Pilot** will indicate it and will pause the purging cycle.

Activate the backflow prevention device or the filling valve to raise the pressure. The purging cycle will resume automatically once there is sufficient pressure.

The purging cycle is launched for a duration of 30 minutes and will automatically stop after that time is up.

At any time during the cycle, you can:

- Interrupt (or resume) the cycle by pressing on .
- End the cycle and continue to the next step by pressing .

5.7 - Step 4 : Choosing the back-up

It is possible to select the electrical back-up, the back-up boiler or not to declare a back-up.

5.8 - Step 5: Finishing set-up

The **Pilot** will indicate when set-up has been achieved:



And will automatically put itself in standby mode.

The **Premium+ Pilot** can be left in this state until first use.

5.9 - 1st use

To turn on the **Premium+ Pilot**, press .

Long pressing  puts the **Premium+ Pilot** in standby mode.

6 - SETTINGS AND FUNCTIONS

6.1 - Control panel

6.1.1 - Keypad

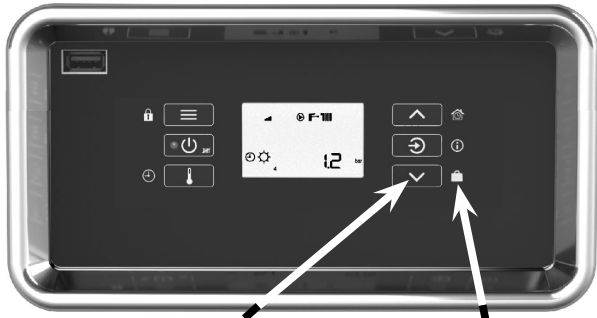

Button Primary function
ex.: decrease / scroll down

Secondary function
ex.: holiday mode

Primary function (short press)	Secondary function (long press)
- menu access - return / cancel	locking / unlocking of the keypad
- switch on	standby mode
- setting the temperatures	program scheduled comfort modes
- increase the setting - scroll up	activate temporary comfort mode
- confirm / remove error - display pressure or T°	information on temperatures and current operating state
- decrease the setting - scroll down	activation of holiday mode

6.1.2 - Display

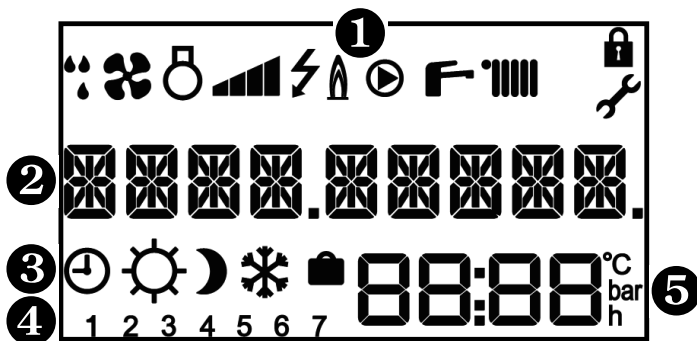

1 Symbols of current operating state

	defrosting in progress		circulating pump working
	ventilator working		domestic hot water activated
	compressor working		heating activated
	power level		keypad locked
	electrical back-up		installer menu
	back-up boiler		

2 9 character message





3 Current comfort mode

	Programming active		Comfort mode		Eco mode
	Frost protection mode		Holiday mode		

4 Day of the week: (1= Monday; 2= Tuesday...)

5 Display zone: temperatures, pressure, settings, time...

6.2 - Menus

Menus (and sub-menus)	access buttons
menu USER	
menu INSTALLER <i>(Display here under will be shown or hidden according to product configuration)</i> <ul style="list-style-type: none"> - HP CIRC : Setting the speed of HP circulating pump - CIRC.PUMP : Setting the speed of heating circulating pump - OUTS.TMAX : Outside temperature on the warmest day - OUTS.TMIN : Outside temperature on the coldest day - BACKUP : Choice of back-up - HEAT CURV 1 : Setting the heat curve 1 - HEAT TMAX. : Heat curve 1 setpoint on the coldest day - HEAT TMIN : Heat curve 1 setpoint on the warmest day - HEAT CURV 2 : Setting the heat curve 2 - TMAX HEAT 2 : Heat curve 2 setpoint on the coldest day - TMIN HEAT 2 : Heat curve 2 setpoint on the warmest day - SHARING : Activation of priority sharing - ANTI.BACT : Activation of anti-bacteria function 	 + 
menu EXPERT <ul style="list-style-type: none"> - SETTINGS : Access to all parameters - DISPLAY : State of operation of the pilot - DATA CALC : Temperatures and time delays in progress - COUNTERS : Operation counters - CONFIGURA. : Choice of circuits and their controls - AIR BLEED : Activation of a special air purge cycle - MANUAL : Manual operation of component for diagnostics - COMMISSIO: Access to the set-up - MODBUS : Remote control setting up - SOFTWARE : Manage software version 	 + 

Press  to exit the menus and sub-menus.

6.3 - Actions to be activated using a combination of buttons

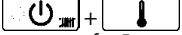
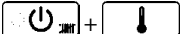
Action	combination of buttons
Reset counters to zero Certain counters cannot be reset to zero. Only the counters which can be reset are affected by this action.	in the «counters» menu  press for 5s
Reset to default settings (return to factory settings)	in the «settings» menu  press for 5s

6.4 - List of parameters which can be set

Parameter N°	Description	Unit	Range of setting	Factory setting
P202	Maximum exterior temperature (warmest day for heat curve)	°C	11 to 25	20
P203	Minimum exterior temperature (coldest day for heat curve)	°C	-30 to 10	-5
P204	Summer/winter changeover: choice of changeover method	-	<i>AUTO</i> : changeover is done automatically based on the exterior temperature <i>MANU</i> : changeover is done manually by the user	<i>MANU</i>
P205	Summer/winter time delay: time period for observation of the exterior temperature before automatic season changeover. Only used if automatic changeover is activated.	hour	0 to 48	12
P206	Reactivity: the temperature for heating takes into account the ambient temperature to accelerate heating time when heating is switched on or restarted.	-	<i>YES</i> : reactivity activated <i>NO</i> : reactivity deactivated	<i>NO</i>
P207	Anticipation of heating: heating restarted before return from holidays (for getting a home already at the set temperature on return)	-	<i>YES</i> : anticipation activated <i>NO</i> : anticipation deactivated	<i>NO</i>
P208	Minimum exterior temperature for operation using only the HP. The back-up is authorised to operate in colder temperatures.	°C	P209 to 20	2
P209	Maximum exterior temperature for operation using only the back-up. The heat pump is authorised to operate in warmer temperatures.	°C	-20 to P323	-20
P210	Operation in peak hours (HP/HC contact open)	-	0: no operation allowed 1: HP limited to 1st power stage 2: HP limited to 2nd power stage 3: full HP without back-up 4: HP + 1 stage back-up (2kW) 5: HP + 2 stages back-up (4kW) 6: Full authorization: HP + 3 stages back-up (6kW) 7: back-up (6kW or boiler) without HP 8: anti-frost confort level 9: eco 10: do not use	6
P212	Type of back-up	-	<i>NO</i> : no backup <i>ELEC</i> : electrical back-up <i>BOIL</i> : back-up boiler	<i>NO</i>
P213	Heat pump time-out: allows the heat pump to continue running for a period of time after intervention of the back-up	min.	1 to 20	5
P214	Difference in temperature between the back-up and the heat pump	°K	0 to 7	<i>ELEC</i> : 4 <i>BOIL</i> : 7
P215	Presence of a heat pump	-	0: operation without heat pump 1: presence of a heat pump	1
P216 to P225	Not concerned	-	Do not change the setting	0.5
P221	Choix du compresseur en fonctionnement	-	0 to 2	0

Parameter N°	Description	Unit	Range of setting	Factory setting
P226	Choice for pressure sensor		0: no pressure sensor 1: IMIT/HUBA sensor (4 bar) 2: ELTEK sensor (4 bar) 3: 6 bar sensor	1
P227	Speed of heat pump circulator pump	%	10 to 100	100
P228	Post-circulation of the heat pump circulator pump	-	Do not change the setting	3
P230	Speed of heating circuit circulator pump	%	10 to 100	100
P231	Setpoint temperature for heating circuit	°C	AUTO: automatic set temperature from the air sensor or exterior sensor (if connected) or 20 to 70: setting fixed in °C	AUTO
P232	Setpoint temperature at the coldest day	°C	P233 to 70	70
P233	Setpoint temperature at the warmest day	°C	20 to P232	40
P234	Action of circulating pump for heating circuit	-	0: permanent 1: controlled by room temperature / room thermostat 2: controlled by room temperature with lower setpoint when room temperature target is reached («anti-cold radiators» function)	1
P235	Lowering of the Heating setpoint : lowering applied to the heating temperature when room has reached the temperature target	°K	0 to 30	4
P236	Lowering in ECO: temperature lowering applied to the heating setpoint during ECO mode.	°K	0 to P237	10
P237	Lowering in Frost protection : temperature lowering applied to the heating setpoint during Frost protection mode	°K	P236 to 40	20
P238	Self-adaptability: automatic correction of the heat curve based on the room temperature on a 24h cycle	-	YES: correction activated NO: correction deactivated	NO
P239	Complementary self-adaptability: automatic correction of the temperature on a 3h cycle of room temperature	-	YES: correction activated NO: correction deactivated	NO
P247	Room temperature hysteresis (requires an room temperature sensor) : room temperature deviation triggering a heating demand	°K	0.1 to 1	0.5
P250	Circuit 2 - Circulator speed (in case of 2nd heating circuit kit)	%	10 to 100	100
P251	Circuit 2 - Setpoint temperature for heating circuit	°C	AUTO : automatic setpoint from air or outside probe if connected or 20 to 70 : fixed set point in °C	AUTO
P252	Circuit 2 - Setpoint temperature at the coldest day	°C	P253 to 70	70
P253	Circuit 2 - Setpoint temperature at the warmest day	°C	20 to P252	40
P254	Circuit 2 - Action of circulating pump for heating circuit	-	0: permanent 1: controlled by room temperature / room thermostat 2: controlled by room temperature with lower setpoint when room temperature target is reached («anti-cold radiators» function)	1
P255	Circuit 2 - Lowering of heating setpoint : lowering applied to the heating temperature when room has reached the temperature target	°K	0 to 30	4
P256	Circuit 2 - Lowering in ECO: temperature lowering applied to the heating setpoint during ECO mode.	°K	0 to P257	10
P257	Circuit 2 - Lowering in Frost protection : temperature lowering applied to the heating setpoint during Frost protection mode	°K	P256 to 40	20
P258	Circuit 2 - Self-adaptability: automatic correction of the heat curve based on the room temperature on a 24h cycle	-	YES : correction enabled NO : correction disabled	NO

Parameter N°	Description	Unit	Range of setting	Factory setting
<i>P259</i>	Circuit 2 - Complementary self-adaptability: automatic correction of the temperature on a 3h cycle of room temperature	-	<i>YES</i> : correction enabled <i>NO</i> : correction disabled	<i>NO</i>
<i>P267</i>	Circuit 2 - (mixed circuit option) - Room temperature hysteresis (requires a room sensor): room temperature deviation triggering a heating demand	°K	<i>0.1</i> to <i>1</i>	<i>0.5</i>
<i>P271</i>	Domestic sharing: simultaneous operation of heating and domestic hot water production at the end of the tank's heating cycle. Increases the available heating time for installations with a larger volume of domestic hot water.	-	<i>YES</i> : sharing activated <i>NO</i> : sharing deactivated	<i>NO</i>
<i>P272</i>	Anti-legionellosis – activation and choice of frequency: the cycle raises the temperature in the domestic hot water tank. This cycle eliminates the bacteria through thermal shock.	-	<i>0</i> : protection deactivated <i>1</i> : (monthly) : the cycle is carried out at the beginning of each month, on the first day <i>P273</i> of the month <i>2</i> : (weekly): the cycle is carried out each week on day <i>P273</i>	<i>0</i>
<i>P273</i>	Anti-legionellosis – choice of day to carry out anti-legionellosis cycle	-	<i>1</i> (Monday) to <i>7</i> (Sunday)	<i>2</i>
<i>P275</i>	Circulating pump speed during production of domestic hot water	%	<i>10</i> to <i>100</i>	<i>100</i>
<i>P278</i>	Lowering of the domestic hot water temperature in ECO mode.	°K	<i>0</i> to <i>40</i>	<i>10</i>
<i>P279</i>	Maximum heating time of the domestic hot water tank (too long heating time function)	min.	<i>5</i> to <i>60</i>	<i>20</i>
<i>P281</i>	Domestic hot water hysteresis : temperature drop in the domestic hot water tank to start a new heating cycle	°K	<i>2</i> to <i>15</i>	<i>5</i>
<i>P282</i> to <i>P291</i>	Not concerned	-	Do not change the setting	<i>5</i> or <i>60</i>

6.5 - Description of functionalities

6.5.1 - Functions related to heating

6.5.1.1 - AUTO temperature (heat curve)

The set temperature for heating decreases with the exterior temperature, which allows the installation to operate at a low temperature throughout the majority of the heating season and improves the seasonal efficiency of the installation.

This function can be activated by setting *P231* to *AUTO*.

Setting the heat curve is done using parameters *P202*, *P203*, *P232* and *P233*.

RADIATOR application:

P202 (TEMA) = 20°C *P233* (TCMI) = 40°C

P203 (TEMI) = -5°C *P232* (TCMA) = 70°C

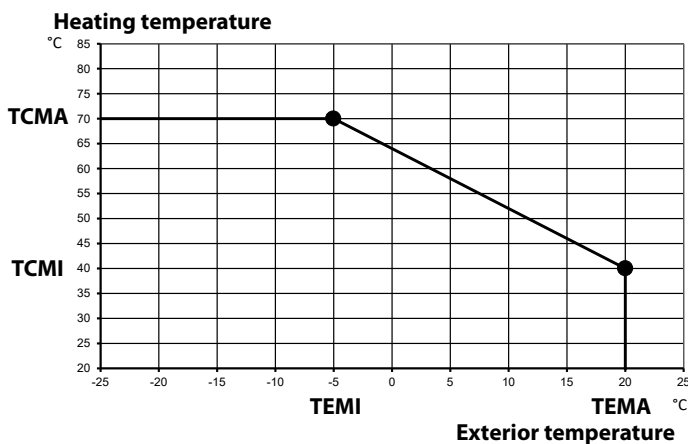

UNDERFLOOR HEATING application:

P202 (TEMA) = 20°C *P233* (TCMI) = 25°C

P203 (TEMI) = -5°C *P232* (TCMA) = 45°C

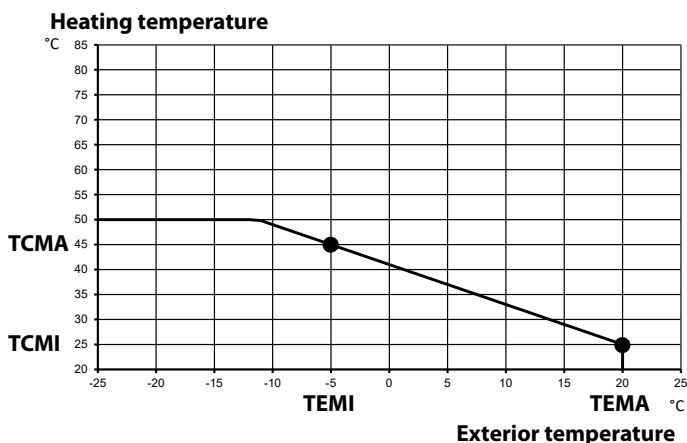

Note:

In manual operation, it is possible for the user to set the set temperature in the range of TCMI to TCMA.

6.5.1.2 - Lowering of the temperature

The set temperature of heating can be lowered at the same time as the ambient temperature when in Eco or Frost protection modes to improve the heat pump's performance.

The set temperature in comfort mode is the reference point. The set temperature applied in Eco or Frost protection mode is the temperature in comfort mode lowered by the differential:

- *P236*: lowering of the temperature in ECO mode.

- *P237*: lowering of the temperature in Frost protection mode.

6.5.1.3 - Auto-adaptability

The auto-adaptability function allows to continually correct the heat curve to correspond to the needs of the household.

Auto-adaptability operates on two modes, which can be independently activated:

- primary auto-adaptability (activated by *P238*) examines the heating needs over 24h cycles and adjusts the set temperature for heating when ambient temperature is requested.

- complementary auto-adaptability (activated by *P239*) examines the heating needs over 3h cycles and adjusts the set temperature when ambient temperature is not requested. Complementary auto-adaptability requires the presence of an ambient temperature sensor and the activation of the anti-cold radiators function (*P234* = 2).

6.5.1.4 - Ambient temperature reactivity

The reactivity function allows the pilot to increase its set temperature for heating when the temperature read by the ambient temperature sensor is far from the set temperature.

In particular, it allows an accelerated increase in ambient temperature when returning to comfort mode.

This function is activated using parameter *P206* and requires the presence of an ambient temperature sensor.

6.5.2 - Programming and timeout functions

6.5.2.1 - Anticipation of return from holiday

When this function is activated, the time of return from holiday mode is no longer considered as the time for heating to resume, but instead is considered as the time that the ambient temperature should be at the set temperature. And so, the heating will resume in advance based on the planned return from holiday mode.

This anticipation can vary based on if the heating circuit has a weak inertia (*RADIATOR* setting) or strong inertia (*FLOOR* setting). It also depends on the exterior temperature read (advanced anticipation on cold days).

The pilot uses a arbitrary initial time-delay which may cause discomfort on the first use of the function (first return from holiday). The length of anticipation is automatically adjusted after the first use.

This function can be activated by setting parameter *P207* to *YES*.

6.5.2.2 - Automatic summer/winter changeover

With the automatic summer/winter changeover function activated, the pilot decides when to enact the changeover from one season to another, independently from the choice made by the user via the on/off button.

The pilot examines the exterior temperature for an extended period of time (standby time) and uses the maximum exterior temperature for heating («*TMAXEXTER*»), corresponding to parameter *P202* as a reference point:

- If the observed exterior temperature is continually above the maximum temperature, the pilot switches to summer mode.
- If the observed exterior temperature is continually below the maximum temperature, the pilot switches to winter mode.

This function can be activated by setting parameter *P204* to *YES*.

Parameter *P205* allows the adjustment of the length of standby time observed by the pilot before the changeover from one season to the other.

6.5.3 - Ambient temperature and heating circulation control functions

6.5.3.1 - Ambient temperature sensor hysteresis

Differential between the set ambient temperature and the measured ambient temperature to activate or deactivate a heating request.

Only applicable if an ambient temperature sensor is connected.

Controlled by parameter *P247*.

6.5.3.2 - Circulator pump speed

Speed is adjustable through parameter *P230*.

Also adjustable through the installer menu *INSTALLER: «CIRC. PUMP»*.

6.5.3.3 - Heating circulator control

Heating circulation can be permanent or controlled by an ambient temperature control.

If being controlled, the heating circulator will only be activated when there is an ambient temperature request.

Control activated through parameter *P234*.

6.5.3.4 - Anti-cold radiators

This function is only possible with an ambient temperature sensor.

Circulation is always controlled by the ambient temperature control. When the set ambient temperature is reached, the pilot adopts a lower set water temperature but continues to circulate so the radiators do not become cold.

This function can be activated by setting parameter *P234* to *2*.

The set temperature can be lowered through parameter *P235*.

6.5.4 - Functions related to the production of domestic hot water

6.5.4.1 - Domestic priority sharing

Allows the operation of the heating circuit at the end of the domestic hot water heating cycle when the tank's temperature has been raised sufficiently but before the cycle has been completed).

This function can be activated by setting parameter *P271*.

6.5.4.2 - Anti-legionellosis protection

This function activates a cycle which raises the temperature in the domestic hot water tank above the set temperature so as to eliminate any bacteria. This cycle is carried out at regular intervals.

If the function is activated, the cycle will be carried out at the chosen frequency and on the day of week chosen:

- Activation / choice of frequency at *P272*: deactivated, monthly, or weekly.
- Choice of day at *P273*: if the frequency is weekly, the cycle will be carried out each week on the selected day. If the frequency is monthly, the cycle will be carried out on the first day chosen in the month (ex. first Monday of the month).

Note: If holiday mode is engaged for more than 3 days, an anti-legionellosis cycle will run at the exiting of holiday mode.

Note:

The cycle starts by default at 22:00 with a set temperature of 60°C.

6.6 - Heat pump circulator speed

Speed is adjustable through parameter *P227*.

Also by *INSTALLER* : «*HP.CIRC.*».

7 - MAINTENANCE AND TROUBLESHOOTING



- **All work on the pilot must be carried out by a qualified professional.**
- **Follow all safety instructions!**
- **Disconnect the pilot from the electrical supply before opening it.**
- **Except for certain operations, it is not necessary to drain the system to work on the components.**
- **If the system must be drained, close the overflow valves and open the drainage valve.**
- **Do not get water on the control components.**

7.1 - Maintenance



**Operation to carry out at least
ONCE PER YEAR
BY A QUALIFIED PROFESSIONAL**

Clean the filter valve:

- 1 - Turn the knob to close the filter valve.
- 2 - Unscrew the access cap (a)
- 3 - Remove the clips and then remove the filter for cleaning (b)
- 4 - Put the valve back together.
- 5 - Open the heating circuit by turning the knob on the filter valve again.

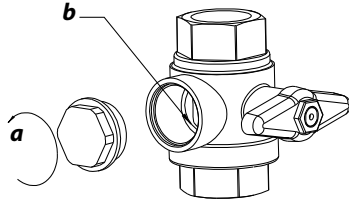

Note :

According to the heat pump connected to the pilot, the filter valve is replaced by a filter. When cleaning the filter, the heat pump and the pilot must be switched off in order to avoid any water flow. Valves situated before and after the filter must be closed before cleaning.

7.2- Diagnostics

7.2.1 - Loading the operating history

The operating history is saved in the memory of the electronic board. This data can be loaded onto a USB stick. The USB port is located behind the front panel, to the, to the bottom left of the screen.

- 1) Get the USB drive that comes with the PREMIUM+ driver.
- 2) Insert the key into the USB port (on the front)
- 3) As soon as the USB stick is recognized* the file transfer will begin. This can take several minutes (depending on the amount of operating history to transfer).
- 4) When the transfer is complete there will be a sound signal and the message: «REMOVE USB STICK» will appear.

Remove the USB stick, **BUT BE SURE NOT TO REMOVE IT BEFORE THIS MESSAGE IS DISPLAYED.**

- 5) A file named «C14_historique» will be generated onto the USB stick. It contains the recent operating history of the pilot and the heat pump.

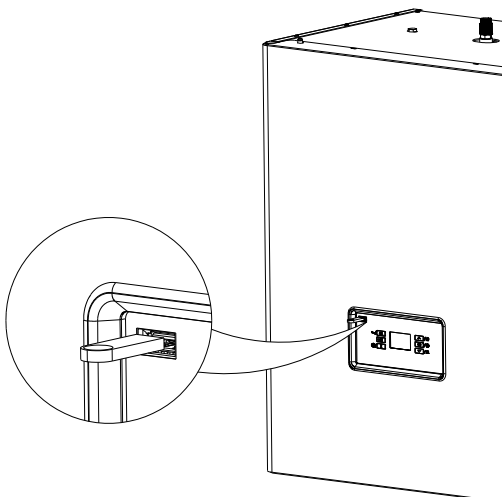

* if the USB stick is not recognized, disconnect and reconnect the electrical supply to the appliance and try again.

If the USB stick is still not being recognized, try a different USB stick.

In the user menu, the *USB* sub-menu allows you to set the frequency of monitoring of operating history (every minute, every 30 seconds...). These changes are not retroactive, they will only be visible in the *USB* history in the period following the changes being applied.

7.2.2 - Consulting the current operating state of the system

Enter the *EXPERT* menu (+) and then in the *DISPLAY* sub-menu, or enter the *DISPLAY* sub-menu directly by long pressing .

The *DISPLAY* sub-menu gives you access to the following values:

<i>AMBIENCE 1</i>	Measured ambient temperature (if using an ambient temperature sensor)
<i>THERMOSTA</i>	State of contact (if using a thermostat): 0 = open (no request) 1 = closed (request)
<i>T_WATER</i>	Temperature of domestic hot water
<i>OUTSIDE</i>	Exterior temperature
<i>O/1 ECO</i>	State of peak hours contact : 0 = open (peak hours) 1 = close (standard operation)
<i>HEAT CURVE</i>	Current temperature set point (determined by the heat curve)
<i>T_PILOTE</i>	Temperature at pilot outlet
<i>VERSION</i>	Pilot version number

The data specific to the heat pump is accessible in the *HP* sub-menu:

<i>T_FLOW</i>	Temperature at heat pump outlet
<i>T_RETURN</i>	Temperature at heat pump inlet
<i>T_AIR</i>	Temperature of heat pump air
<i>T_EVAPOR</i>	Temperature of evaporator
<i>T_COMP 1</i>	Temperature of compressor (compressor n°1 if using heat pumps with 2 compressors)
<i>T_COMP 2</i>	Temperature compressor n°2 (heat pumps with 2 compressors)
<i>VERSION</i>	Heat pump version number
<i>T_COND</i>	Temperature of condenser (sensor)
<i>COMP1</i>	Compressor 1 working state
<i>COMP2</i>	Compressor 2 working state

7.2.3 - Water sensors

Ohmic values for T_{PILOTE} (pilot outlet) and T_{WATER} (domestic water sensor placed in the tank) sensors

10 K Ω à 25°C

T (°C)	R (ohms)	T (°C)	R (ohms)
0	32 550	50	3 605
5	25 340	55	2 990
10	19 870	60	2 490
15	15 700	65	2 084
20	12 490	70	1 753
25	10 000	75	1 481
30	8 060	80	1 256
35	6 535	85	1 070
40	5 330	90	915
45	4 372		



7.2.4 - Exterior sensor

Ohmic values for OUTSIDE (exterior) sensor

12 K Ω à 25°C

T (°C)	R (ohms)	T (°C)	R (ohms)
-30	171 800	5	28 600
-25	129 800	10	22 800
-20	98 930	15	18 300
-15	76 020	20	14 770
-10	58 880	25	12 000
-5	45 950	30	9 804
0	36 130		

7.2.5 - Consulting the counters

To consult the pilot and heat pump counters, enter the *EXPERT* menu by pressing simultaneously on  + , and select the *COUNTERS* sub-menu.

Counter n°	Description	Unit
C-00*	Time of DHW request from tank	h
C-01*	Time of heating request from ambience (circuit n°1)	h
C-02*	Time of heating request from ambience (circuit n°2)	h
C-06*	Time of heat pump operation	h
C-07*	Time of boiler heating request	h
C-08*	Stage 1 Operating Time of the electrical back-up	h
C-09*	Stage 2 Operating Time of the electrical back-up	h
C-10*	Stage 3 Operating Time of the electrical back-up	h
C-11*	Defrosting cycles	quantity



HEAT PUMP

C-20	Heat pump operating time	h
C-21	Number of start-ups from compressor n°1	quantity
C-22	Number of start-ups from compressor n°2	quantity



Counter n°	Description	Unit
C-23	Operating time of compressor n°1	h
C-24	Operating time of compressor n°2	h
C-25	Defrosting cycles	quantity
C-26	Frequent defrosting errors	quantity
C-27	High pressure (switch) on compressor n°1	quantity
C-28	Activation of high pressure switch for compressor n°2	quantity
C-29	Activation of low pressure switch for refrigerant fluid	quantity
C-30	Activation of high temperature for compressor n°1 exhaust	quantity
C-31*	Activation of high temperature for compressor n°2 exhaust	quantity
C-32	Overheating at heat pump outlet	quantity
C-35	Insufficient flow rate	quantity
C-36	BUS error	quantity

PILOT

C-40	Time of DHW request from tank	h
C-41	Time of heating request from ambience (circuit n°1)	h
C-42	Time of heating request from ambience (circuit n°2)	h
C-45	Time of heating request for back-up boiler	h
C-46	Stage 1 Operating Time of the electrical back-up	h
C-47	Stage 2 Operating Time of the electrical back-up	h
C-48	Stage 3 Operating Time of the electrical back-up	h
C-49	Overheating at pilot outlet error	quantity
C-50	Lack of water pressure error	quantity
C-51	Lack of water pressure defect	quantity
C-52	Error loss of BUS connection	quantity

* counters which can be reset to zero by long pressing (5s) on  +  in the *COUNTERS* menu.

7.2.6 - Manual forcing of components

Enter the *EXPERT* menu ( + ) and then the *MANUAL* sub-menu.

7.2.6.1 - Circulator pump

Activate the forced operation of the circulator pump to check that circulation is working properly. To activate forced operation press .

7.2.6.2 - Electrical back-up

Activate (always in the *MANUAL* menu of the pilot) the forced operation of the electrical back-up by pressing .



7.2.6.3 - Back-up boiler

Activate (always in the *MANUAL* menu of the pilot) the forced operation of the Back-up boiler by pressing .

7.2.7 - Errors indicated by the pilot

Press  to stop the sound signal (the error persists)

Display	Error	Possible causes	Consequences	Reset
<i>AIR HP</i>	T _{air} error	The heat pump temperature sensor (T _{air}) is defective or not connected properly. - Check Cable and Probe Connector Status - Check the ohmic value of the probe - Replace probe if fault is found	heat pump stopped	automatic after repair
<i>CIRC PUMP</i>	Power cable or PWM circulator cable error	The cables for the circulator (heating/water) are defective or not connected properly. - Check PWM cable connection to circulator - Check power cable connection - For installations equipped with a underfloor heating, check for a possible power cut by the underfloor heating safety (LTP)	complete stop	manual
<i>AMBI ENCE</i>	Amb error	The ambient temperature sensor is defective (error when measuring the ambient temperature)	heating circuit stopped	automatic after repair
<i>BLOC. CIRC</i>	Circulator pump blocked	The circulator (heating/water) is blocked or is working with a load loss which is too high. - Check that na valves are closed on the circuit - Check the status of the filter - Reset and verify that the circulator rotates with a screwdriver and the central circulator screw	complete stop	manual
<i>BUS</i>	BUS	BUS communication error. - Check BUS connection between heat pump and hydraulic pilot - Verify that the BUS cable is routed away from power cables or other disturbance sources (neons, appliances, ...)	complete stop	automatic after repair
<i>AMB BUS</i>	Amb BUS error	The ambient temperature sensor («Amb» terminals on the pilot) is defective or not connected properly	heating circuit stopped	automatic after repair
<i>COND. SENSO DIAG</i>	Condenser fluid pressure sensor error	The refrigerant circuit pressure sensor is defective or not connected properly	operation in downgraded mode	automatic after repair
<i>EVAP. SENSO</i>	Evaporator fluid pressure sensor error	The refrigerant circuit pressure sensor is defective or not connected properly	heat pump stopped	automatic after repair
<i>PRES. SENSO</i>	Pressure sensor error	The heating water pressure sensor is defective or not connected properly	complete stop	automatic after repair
<i>INVR. COMM.</i>	Inverter communication error	HP circuit board is disconnected or defective - Check condition of internal wiring to heat pump	heat pump stopped	manual
<i>CP CTRL</i>	Loss of control of inverter	Error detected by the HP circuit board. Wait about 20 minutes before rearming and make a reading on USB key if the fault occurs again.	heat pump stopped	manual
<i>CP ELEC</i>	Inverter having electrical problems	Error detected by the HP circuit board. Wait about 20 minutes before rearming and make a reading on USB key if the fault occurs again.	heat pump stopped	manual
<i>CP MECA</i>	Inverter having mechanical problems	Error detected by the HP circuit board. Wait about 20 minutes before rearming and make a reading on USB key if the fault occurs again.	heat pump stopped	manual
<i>CP THERM</i>	Inverter having thermal problems	Error detected by the HP circuit board. Wait about 20 minutes before rearming and make a reading on USB key if the fault occurs again.	heat pump stopped	manual
<i>CP1 OVRHT. ERR</i>	Multiple overheatings on compressor 1	- The set temperature for heating during warmer months is too high - Problem with refrigerant fluid load	heat pump stopped	manual
<i>CP2 OVRHT. ERR</i>	Multiple overheatings on compressor 2	- The set temperature for heating during warmer months is too high - Problem with refrigerant fluid load	heat pump stopped	manual

Press  for 2 seconds to remove the errors manually (indicated by «press  »).

Display	Error	Possible causes	Consequences	Reset
FLOW OR FLOW 1	No flow HP circuit	- The filter valve needs maintenance - A valve on the distribution circuit is closed - The circuit is blocked - The circulator has been switched off by the underfloor heating safety - Check that the check valve is mounted upright	heat pump stopped	manual
LOW FLOW DIAG	Insufficient flow rate	- The filter valve needs maintenance - The circuit is blocked	informative message	manual
REV. FLOW	Flow rate is reversed	- The hydraulic connection between the heat pump and the pilot is reversed - The heat pump's inlet and outlet sensors are reversed - One of the probes TSPAC or TePAC does not return the correct ohmic value	heat pump stopped	manual
FREQ. DEFRO.	Defrosting too often error	- The heat pump's evaporator or the grills of the crankcase heater are obstructed and are preventing proper air flow - The free space around the heat pump to ensure sufficient air flow has not been respected - Problem with refrigerant fluid load	heat pump stopped	manual
LONG DEFRO. DIAG	Defrosting cycle is too long error	- Evaporator sensor improperly positioned - Defrosting valve blocked	informative message	manual
LONG DEFRO.	Defrosting cycle is too long error	- Evaporator sensor improperly positioned - Defrosting valve blocked	heat pump stopped	manual
"MAIN TENAN EXCH ANGER"	Maintenance is needed on the hot water exchanger	- Hot water exchanger is clogged - The tank's water sensor is misplaced	informative message	manual
CLOCK	Clock	Clock is defective - Perform a new date and time adjustment - If the fault persists, replace the Pilot's electronic board	permanent operation in ECO mode	replace circuit board
INV T1/T2	Compressor sensors reversed error	The sensors for compressor 1 and compressor 2 have been reversed (affects the heat pumps and both compressors)	heat pump stopped	manual
SOFTWARE	Software update necessary	The software versions of the heat pump and pilot are incompatible, update the software using the USB key.	complete stop	automatic after repair
HP MEMORY	HP memory card	- Reprogram the heat pump. - If the fault persists, change the PAC main board	heat pump stopped	automatic after repair
MEMORY	Pilot memory card	- Reprogram the pilot. - If the fault persists, change the pilot main board	complete stop	automatic after repair
MODBUS	External control protected by Modbus	- Programming error of the central GTB/GTC - Too many interventions in the same day - Check the programming of the control panel or the PLC that controls the installation	operation of circuits in Frost protection mode	manual or automatic after 24h
HP NUMBER DIAG	Number of HPs connected error	- The HP has been unplugged or switched off - the number of heat pumps declared at P215 is not accurate - Check the fuse status on the outdoor unit - Heat pump three-phase connected with 2 inverted phases	informative message	automatic after repair

The messages signalled by «DIAG» are informative and do not interrupt the operating of the **Pilot**. This information comes from the analysis of the operating history of the **Pilot** and is designed to assist you in the maintenance of your installation.

Display	Error	Possible causes	Consequences	Reset
<i>HP 0 UTPUT.</i>	Overheating at HP outlet	The temperature at the heat pump outlet is abnormally high - Check the status filter valve : Clean the filter - Check PAC circulator flow is sufficient - Check operation of circulators 1 and 2 (option)	heat pump stopped	automatic
<i>HP 0 UTPUT ERR</i>	Multiple overheatings at HP outlet	- Drop in flow rate when traveling through the heat pump - Repeated heating requests for low heating needs (installation design)	heat pump stopped	manual
<i>CP1 POWER</i>	Compressor 1 power supply error	There is a problem with the power supply to the compressor (cable,...)	heat pump stopped	manual
<i>CP2 POWER</i>	Compressor 2 power supply error	There is a problem with the power supply to the compressor (cable,...)	heat pump stopped	manual
<i>EVAP. SENSO.</i>	Defrosting sensor error	Error when measuring the evaporation temperature - Check operation of air probe and low pressure sensor - Check 4-way valve tilting - Check that the compressor starter is not faulty (for affected models) - Check that the evaporator probe is not covered with ice (for affected models)	heat pump stopped	manual
<i>EXT. SENSO. DIAG</i>	Exterior sensor placement error	- The exterior sensor is badly positioned and is being influenced by heat or cold sources - The exterior sensor or the air sensor is defective	informative message	manual
<i>PRES SURE</i>	Lack of water pressure	Water pressure is less than 0.3 bars - The water pressure in the heating circuit must be greater than 0.5bar - Check the heating system for tightness and repair any water leaks - Purge air in high areas and on the pilot - Check that the PAC safety valve is watertight - Check that the pilot safety valve is watertight - Check that the expansion tank is large enough for the installation volume	complete stop	automatic after pressure is returned
<i>CP1 RAMP</i>	Temperature ramp is insufficient for Compressor 1	- Compressor blocked or error in power supply (cable, voltage) - Defrosting valve blocked - Compressor probe 1 failed	HP stopped and restart (with anti-short cycle)	automatic
<i>CP2 RAMP</i>	Temperature ramp is insufficient for Compressor 2	- Compressor blocked or error in poiwer supply (cable, voltage) - Defrosting valve blocked - Compressor probe 2 failed	HP stopped and restart (with anti-short cycle)	automatic
<i>REPR OG / PILOT / HP</i>	Reprogramming error	An error is detected on the reprogramming circuit on one the bus's circuit boards - Try new map programming - If the problem persists, reprogramming must be done in the factory	informative message	automatic after repair
<i>CUTO. LPRE</i>	Low pressure error	- The set temperature for heating during colder months is too low - Check that nothing obstructs the battery or interferes with the fan operation	heat pump stopped	automatic
<i>CUTO. LPRE ERR</i>	Low pressure error	- Check the fan for proper operation - Check the surface condition of the finned battery and remove anything that might impede the passage of air through the rear grille (sheets or other...) - In case of total ice setting, stop the PAC and let it melt, sprinkle with hot water if necessary - The set temperature for heating during colder months is too low - Refrigeration fluid load problem (fluid leakage?) - Blockage or failure of deicing valve or regulator Intervention on the refrigeration circuit by authorised personnel	heat pump stopped	manual

Display	Error	Possible causes	Consequences	Reset
<i>CUTO. HPRE1</i>	High pressure switch HP1	<ul style="list-style-type: none"> - Check the status of the filter valve - Check that the heating system is well drained - Check the PAC circulator for proper operation - The set temperature for heating during warmer months is too high - Clean plate heat exchanger inlet - Problem with refrigerant fluid load - Failure of the check valve or 4-way valve Intervention on the refrigeration circuit by authorised personnel	heat pump stopped	manual
<i>CUTO. HPRE2</i>	High pressure switch HP2	<ul style="list-style-type: none"> - Check the status of the filter valve - Check that the heating system is well drained - Check the PAC circulator for proper operation - The set temperature for heating during warmer months is too high - Clean plate heat exchanger inlet - Problem with refrigerant fluid load - Flow valve or 4-way valve fault Intervention on the refrigeration circuit by authorised personnel	heat pump stopped	manual
<i>T CYLIND</i>	Tank sensor out of place	The water sensor is out of place in the tank, or it is placed too low in the tank (placed below the heat exchanger or near the cold water inlet)	DHW circuit stopped	manual
<i>CP1 SENSO.</i>	T1 defect	Defect of incorrect connection of the temperature sensor for the compressor – or compressor n°1 depending on the model (connector TCP1 on the HP)	heat pump stopped	automatic after repair
<i>CP2 SENSO.</i>	T2 defect	Defect of incorrect connection of the temperature sensor for compressor n°2 (TCP2)	heat pump stopped	automatic after repair
<i>T-WA TER</i>	Tballon defect	Defect of incorrect connection of the temperature sensor for the DHW tank (terminal «Bal»)	DHW circuit stopped	automatic after repair
<i>T-FLOW</i>	TsPAC defect	Defect of incorrect connection of the temperature sensor at the heat pump outlet (TwOUT)	heat pump stopped	automatic after repair
<i>T-PI LOTE</i>	TsEAU defect	Defect of incorrect connection of the temperature sensor of the pilot	back-up stopped	automatic after repair
<i>T-PI LOTE DIAG</i>	Overheating at pilot outlet	<ul style="list-style-type: none"> - Check operation of circulators 1 and 2 (option) - Check the operating status of the power relays of the electric power packs - check the status of the backup boiler control - check that the flow rate of the auxiliary boiler is sufficient. 	back-up stopped	automatic
<i>T-PI LOTE ERR</i>	Multiple overheatings at pilot outlet	Perform the same checks as for the T-PILOT DIAG alert above.	back-up stopped	manual
<i>T-RE TURN</i>	TePAC defect	Defect of incorrect connection of the temperature sensor at the heat pump inlet (TwIN)	heat pump stopped	automatic after repair

8 - SPARE PARTS

8.1 - PREMIUM+ pilot

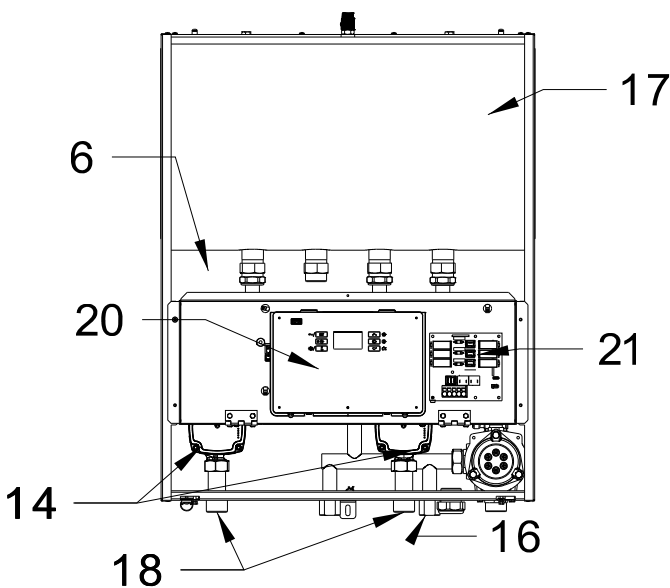
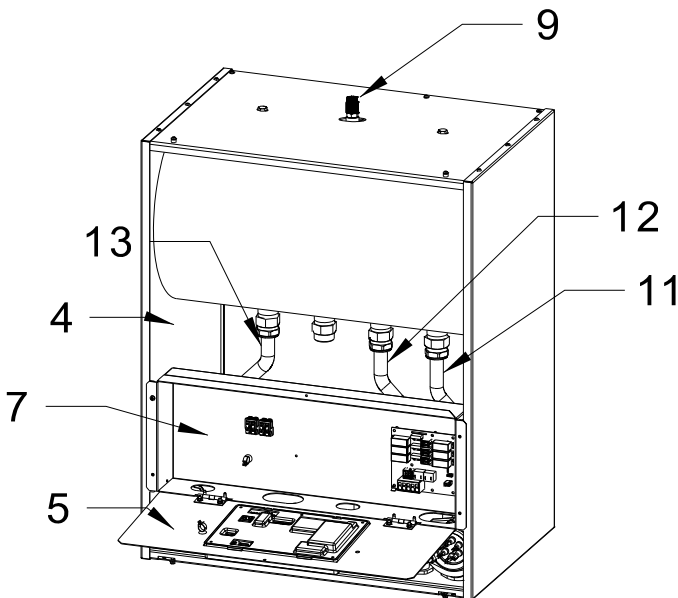
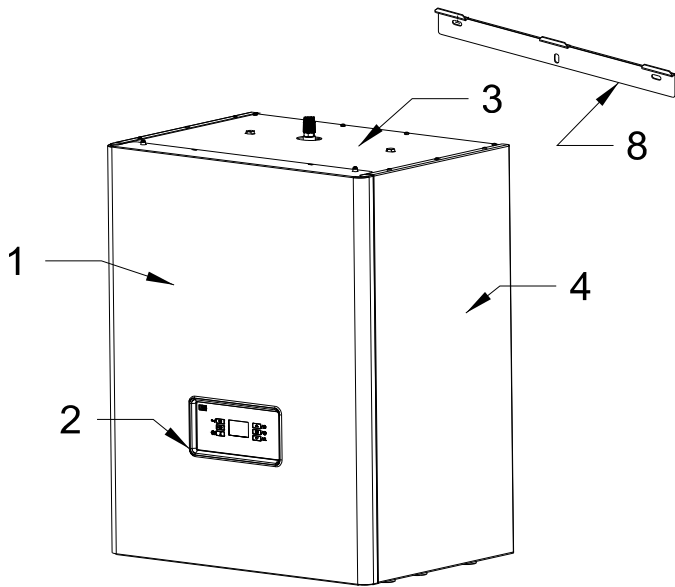

Repère	Référence	Désignation
1	B4485666	Front panel
2	B1759317	Bezel
3	B4485671	Upper cover
4	B4485539	Left side panel
5	B4485539	Right side panel
6	B4485670	Lower cover
7	B4485646	Electronic board casing
8	B4485578	Wall mounting bracket
9	B1239089	Air bleed
10	B4994672	Fully equipped cast iron body
11	B1448826	Body to buffer pipe
12	B1448902	Inlet to buffer pipe
13	B1448828	Buffer to HP outlet pipe
14	B1244393	HP circulating pump
16	B1448904	Outlet manifold
17	B4994837	38L insulated buffer tank
18	B1135120	1" M connection with nut
20	B4994836	Preassembled control board
21	B1244769	Power board
22	B1244718	6kW heating element
23	B1239094	Pressure relief valve
24	B1243661	Pressure sensor
25	B1239012	Thermal safety cutout
26	B1243534	Pilot sensor
NR	B1657415	Heating element joint

Référence	Désignation
B1244401	Outside sensor
B1243578	DHW sensor

Note : Availability of spare parts:

The spare parts of our products are kept available for 10 years, from the date of stop of mass production, except events beyond our control.

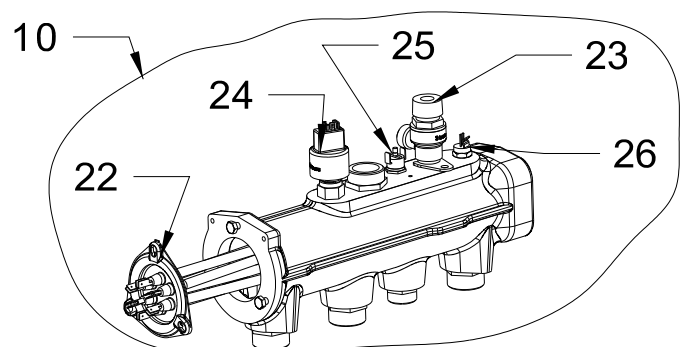

9 - WARRANTY

9.1 - Warranty coverage

- The tank is guaranteed for a period **five (5) years** against breakage, starting from the date of first use if the warranty form was returned to the manufacturer, In the absence of this form, the date of manufacture will be used as a reference point for the start of warranty.
- The spare parts (see attached list) are guaranteed for a period of **two (2) years** starting from the date of first use if the warranty form was returned to the manufacturer, In the absence of this form, the date of manufacture will be used as a reference point for the start of warranty.

The appliance is guaranteed against all manufacturing defects, provided that it was installed according to the instructions provided in this manual and in compliance with all current rules and regulations in the country of installation. All electrical connections should comply with the C15-100 standard.

Under no circumstances does a defective part warrant the replacement of the whole appliance.

The warranty only applies to parts which we (AUER) identify as having been defective at manufacture. If necessary, the part or product should be returned to the manufacturer, but only with prior agreement from our technical department. Labour, transport, and packaging costs are the responsibility of the user. Repairs on a device will not result in compensation.

The warranty on replacement parts ends at the same time as the warranty of the appliance.

The warranty only applies to the appliance and its components and excludes any part or installation external to the appliance: electrical parts, hydraulic components, etc...

The warranty will not apply in the absence of, insufficient, or improper, maintenance of the appliance.

It is essential to carry out regular annual maintenance on the appliances and on the installation to ensure sustained use and durability. This maintenance should be carried out by your installer, or by an AUER-approved technical center. In the absence of regular maintenance the warranty is rendered null and void.

If an appliance is presumed to be the cause of any damage, it must not be moved or tampered with before an expert assessment has been carried out.

9.2 - Limitations of warranty

9.2.1 - General information

The warranty does not apply to defects or damage caused by situations or events such as:

- Misuse, abuse, negligence, improper transport or handling.
- Incorrect installation, or installation which has been carried out without following the instructions in the manual and user guide.
- Insufficient maintenance.
- Modifications or changes carried out on the appliance.
- Impacts from foreign objects, fire, earthquakes, floods, lightning, ice, hailstones, hurricanes or any other natural disaster.
- Movement, imbalance, collapse or settling of the ground or the structure where the appliance is installed.
- Any other damage which is not due to defects in the product.

The Pilot is not guaranteed against:

- Variations in the colour of the appliance or damage caused by air pollution, exposure to chemical elements, or changes brought about by adverse weather conditions
- Dirt, rust, grease or stains which occur on the surface of the appliance.

9.2.2 - Cases (not limited to) for exclusion from warranty

9.2.2.1 - Usages

Cases (not limited) for exclusion from warranty:

- Filling with anything other than domestic cold water from the drinking water network; such as rain-water, well-water, ...etc, or using domestic cold water which is particularly aggressive and not in compliance with the national regulations in effect in the country of use (DTU 60-1 addendum 4 concerning hot water).
- Switching on the appliance without first having filled it with water.

9.2.2.2 - Handling

Cases (not limited) for exclusion from warranty:

- Any damage sustained by impacts or falls during handling after delivery from the factory.
- Deterioration in the condition of the appliance after handling where the instructions in the manual have not been followed.

9.2.2.3 - Installation site

Cases (not limited) for exclusion from warranty:

- Placement of the **Pilot** in a location where it could be subject to ice frost or other adverse weather conditions.
- Not positioning the appliance in accordance with the instructions in the installer manual.
- Installation of the appliance against a wall which cannot support the weight of the appliance when filled with water.

Costs incurred due to access difficulties are not the manufacturer's responsibility.

9.2.2.4 - Electrical connections

Cases (not limited) for exclusion from warranty:

- Faulty electrical connection which does not conform to the national standards in effect.
- Not following the electrical connection diagrams provided in the installer manual.
- Electrical supply being significantly over- or under- the required voltage.
- Not respecting the supply cable sections.
- Absence of, or insufficient electrical protection throughout the appliance (fuses / circuit breaker, grounding...).
- Damages caused after the neutralisation of the safety aquastat, or due to not having installed an appropriate safety aquastat for underfloor heating.

9.2.2.5 - Hydraulic connections

Cases (not limited) for exclusion from warranty:

- Reversing the inlet/outlet connections.
- Water pressure over 7 bars.
- Absence of, improper mounting of, or obstruction of pressure-relief valves.
- Not installing pressure relief valves directly on the outlet for domestic cold water of the appliance.
- Installing pressure relief valves which do not comply with the national regulations in effect (NF EN 1487 for France).
- Using pressure relief valves which are previously used.
- Not respecting the plumbing of the pressure relief valves.
- Abnormal corrosion due to improper hydraulic connections (direct contact between iron/copper) without a sleeve (cast iron, steel, or insulated).
- External corrosion due to piping being improperly sealed.

In no case can compensation be claimed due to damages caused by the absence of thermostatic mitigators.

9.2.2.6 - Accessories

The warranty does not cover faults or defects resulting from:

- Installation of accessories which do not comply with our recommendations.
- The use of accessories which do not come from the manufacturer of the appliance.

9.2.2.7 - Maintenance

Cases (not limited) for exclusion from warranty:

- Not maintaining the appliance.
- Not maintaining the pressure relief valves leading to high pressures.
- Abnormal levels of limescale on the heating elements and of the safety devices.
- Not using parts issued by the manufacturer.
- Outer casing and bodywork being subjected to any external damage.

APPENDIX

A1 - Technical specifications

A1.1 - General characteristics

	PREMIUM+	
Electrical supply	230V mono	400V tri
Power supply cable cross-section	3 G 6mm ²	5 G 2,5mm ²
Circuit breaker	32A	16A
Buffer volume	38L	
Dimensions (H x W x D)	590mm x 845mm x 420mm	
Weight when empty	47 kg	
Hydraulic connection	1"	
Back-up	electric or external boiler	
Electrical back-up output	0 à 6 kW	
Maximum hydraulic pressure	2,5 bar	

A1.2 - EU declaration

This device complies with international electrical safety standards IEC 60335-1, IEC 60335-2-40. The CE marking present on the device attests to its conformity with the following Community Directives, of which it meets the essential requirements:

- Low Voltage Directive (LV): 2014/35/EU.
- Electromagnetic Compatibility Directive: (EMC): 2014/30/EU.
- Ecoconception Directive for Energy-related products: 2009/125/EC.
- Limiting Hazardous Substances (ROHS): 2011/65/EU.

A1.3 - Dimensions

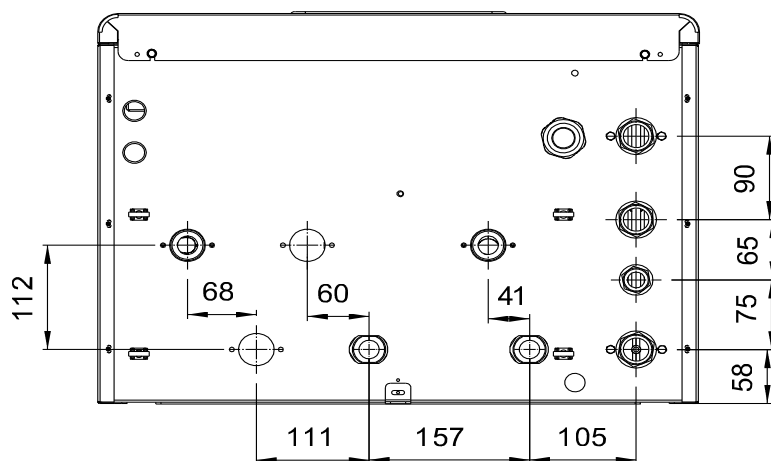
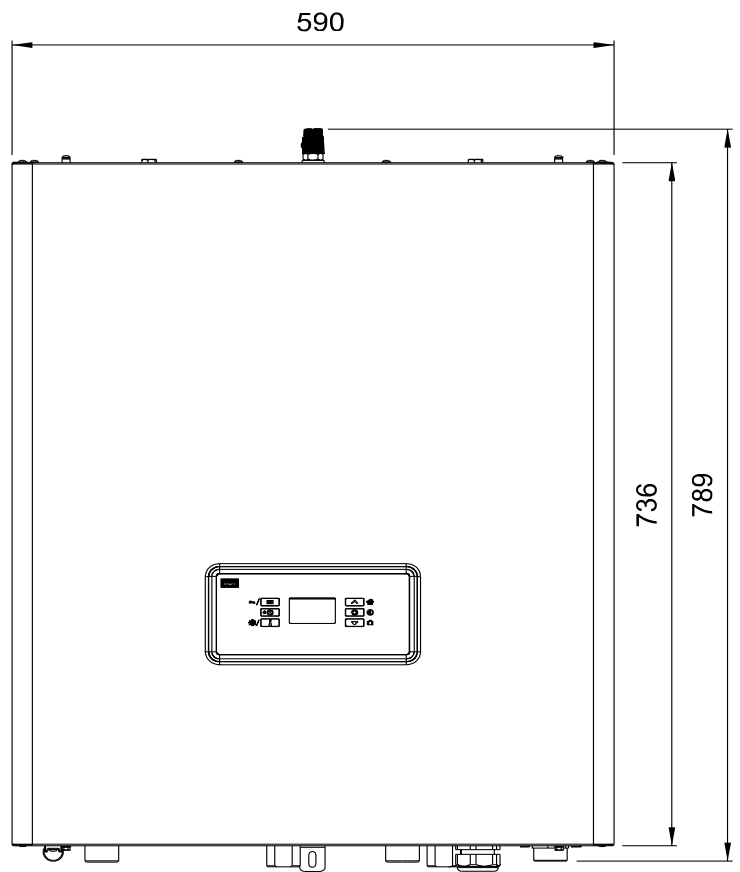
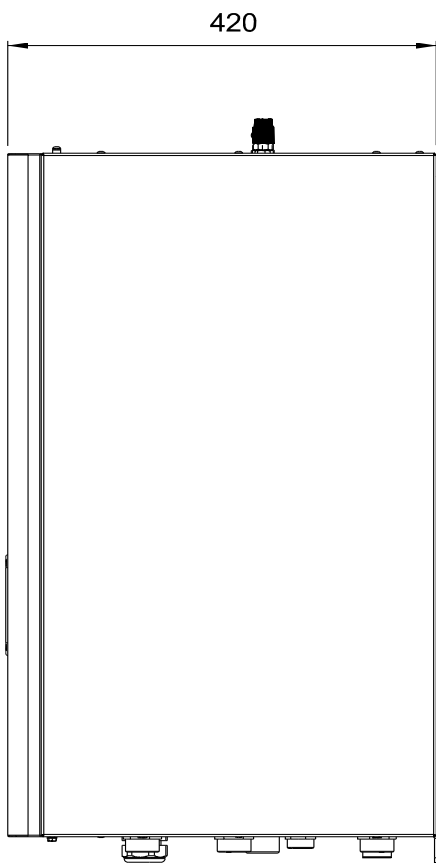

A2 - Hydraulic schematic diagrams

A2.1 - 1 radiators circuit

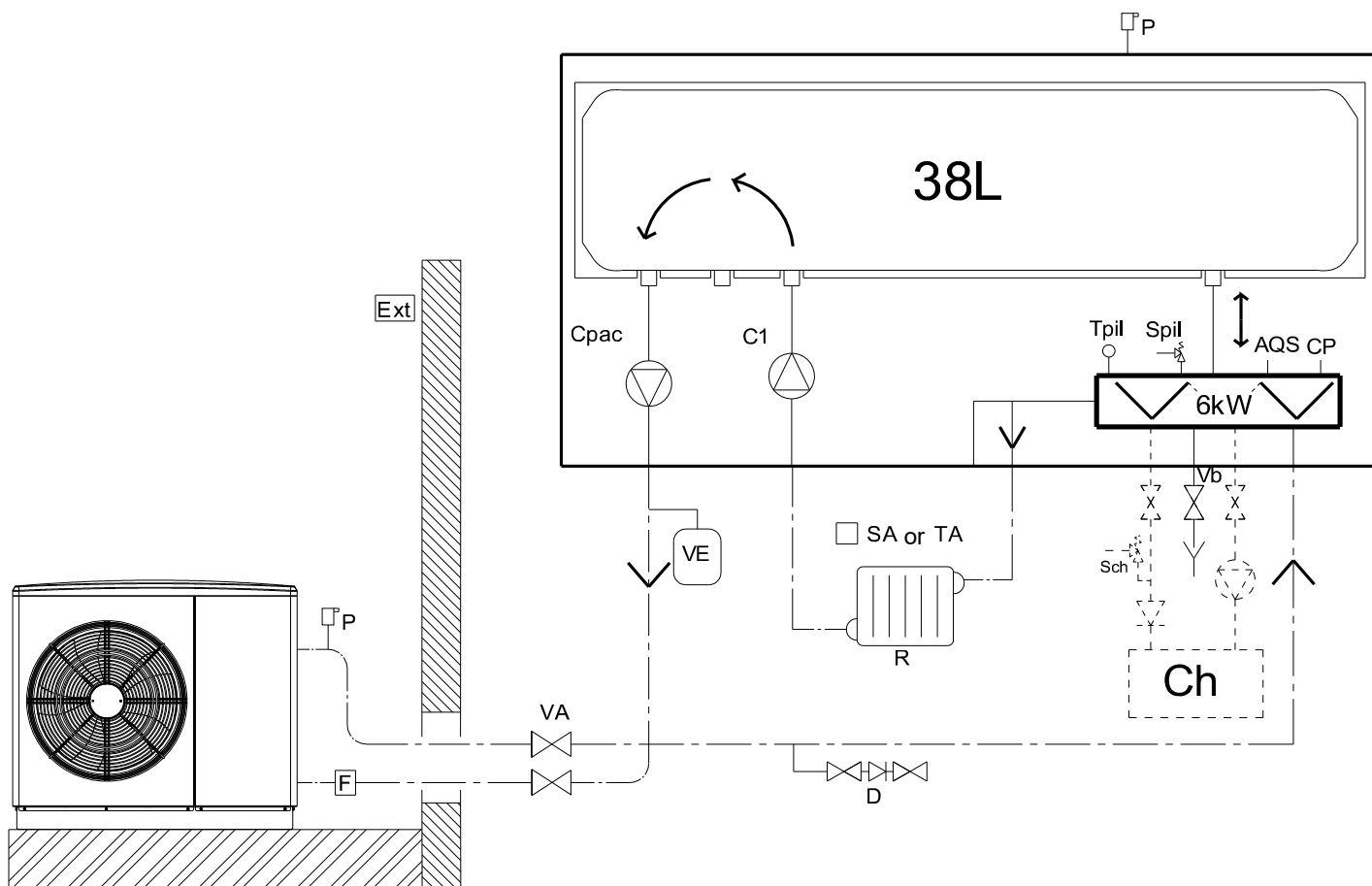

AQS :	Aquastat	R :	Radiators circuit
Ch :	Boiler back-up (optional)	SA :	Ambient sensor
CP :	Pressure sensor	Sch :	Boiler pressure relief valve
Cpac :	HP circulator	Spil :	Pilot pressure relief valve
C1 :	Circuit 1 circulator	TA :	Ambient thermostat
D :	Filling valve/ Disconnecter	Tpil :	Pilot sensor (hot water outlet)
Ext :	Outside sensor	VA :	Shut-off valve
F :	Filter Valve	Vb :	Sludge flushing valve
P :	Air bleed	VE :	Expansion vessel

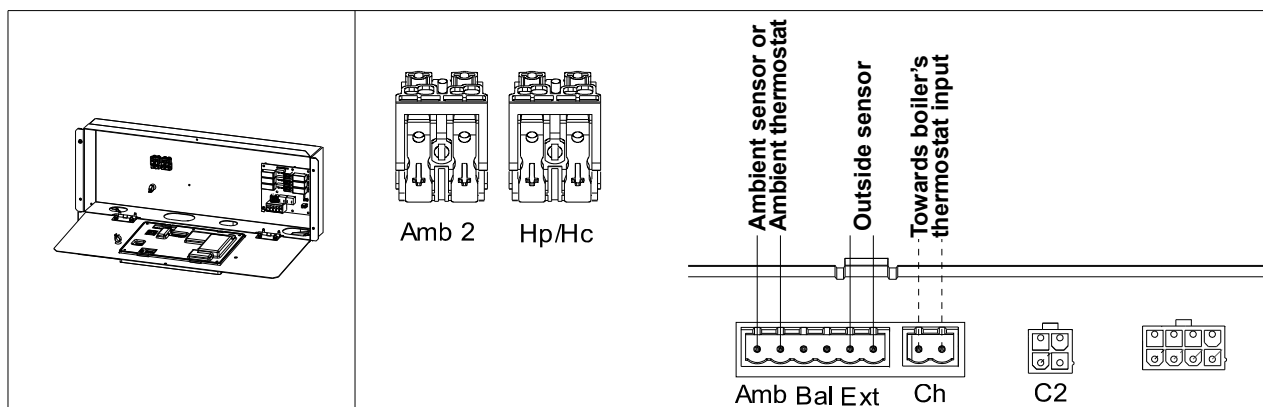

A2.2 - 1 underfloor heating circuit

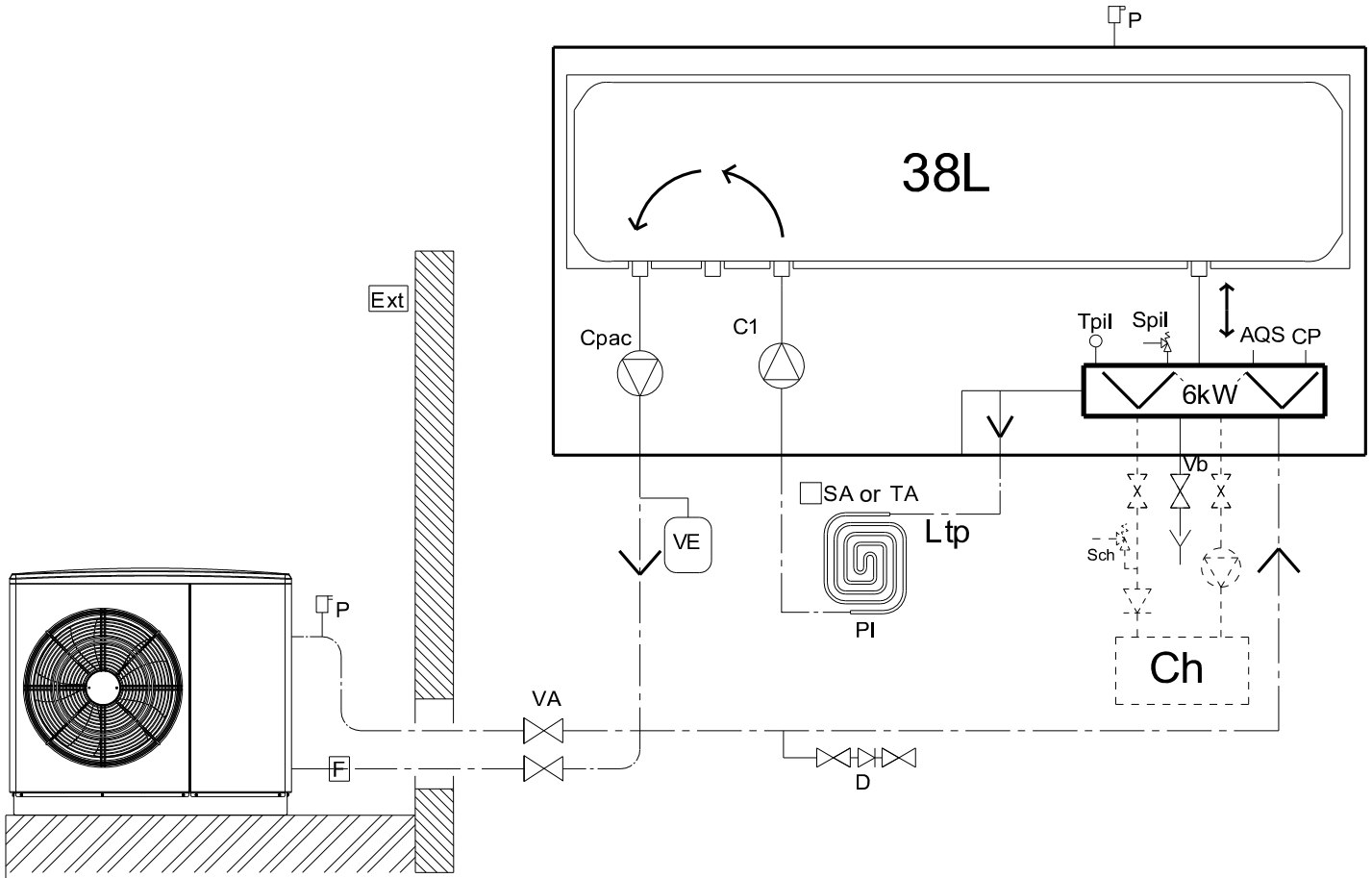

AQS :	Aquastat	SA :	Ambient sensor
Ch :	Boiler back-up (optional)	Sch :	Boiler pressure relief valve
CP :	Pressure sensor	Spil :	Pilot pressure relief valve
Cpac :	HP circulator	TA :	Ambient thermostat
C1 :	Circuit 1 circulator	Tpil :	Pilot sensor (hot water outlet)
D :	Filling valve	VA :	Shut-off valve
Ext :	Outside sensor	Vb :	Sludge flushing valve
F :	Filter Valve	VE :	Expansion vessel
P :	Air bleed		
PI :	Underfloor heating circuit		

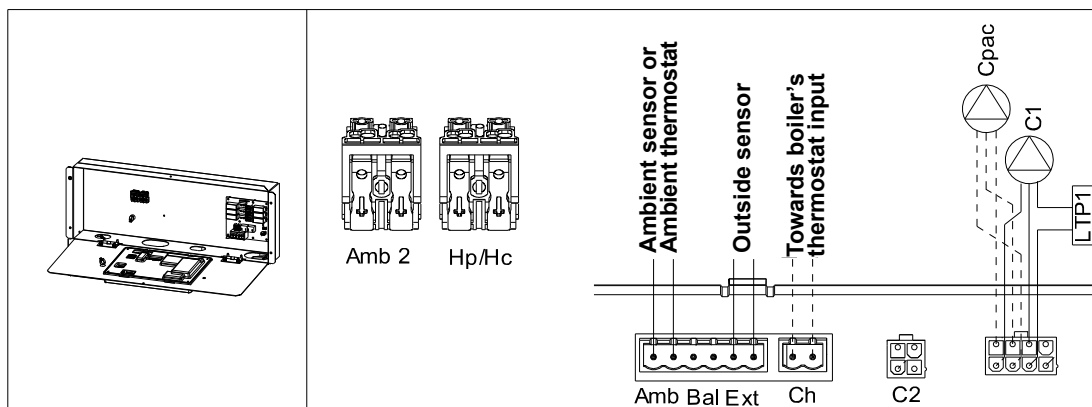

A2.3 - 2 radiators circuits

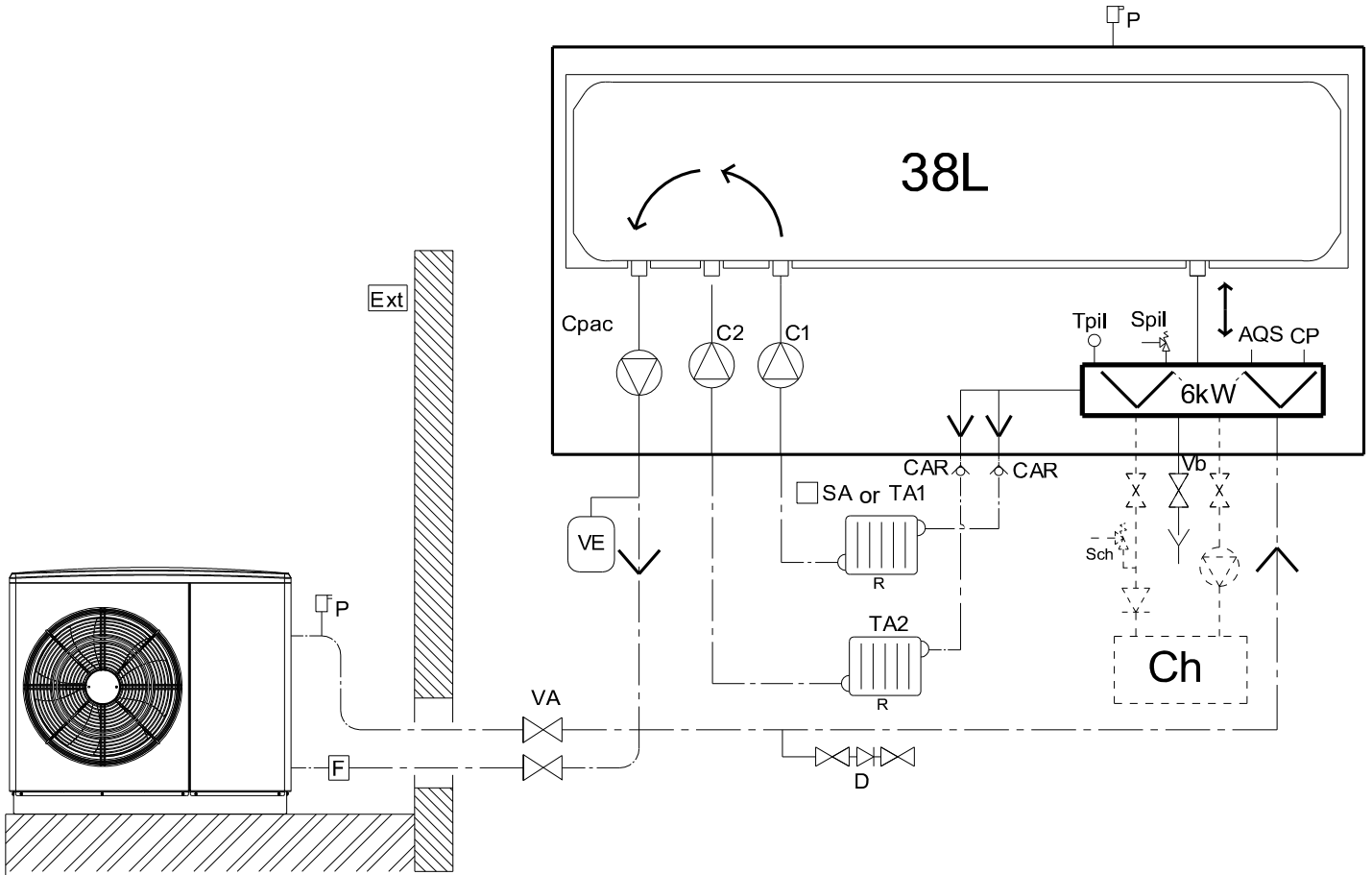

AQS :	Aquastat	P :	Air bleed
CAR :	Non-return valve	R :	Radiators circuit
Ch :	Boiler back-up (optional)	SA :	Ambient sensor
CP :	Pressure sensor	Sch :	Boiler pressure relief valve
Cpac :	HP circulator	Spil :	Pilot pressure relief valve
C1 :	Circuit 1 circulator	TA :	Ambient thermostat
C2 :	Circuit 2 circulator	Tpil :	Pilot sensor (hot water outlet)
D :	Filling valve	VA :	Shut-off valve
Ext :	Outside sensor	Vb :	Sludge flushing valve
F :	Filter Valve	VE :	Expansion vessel

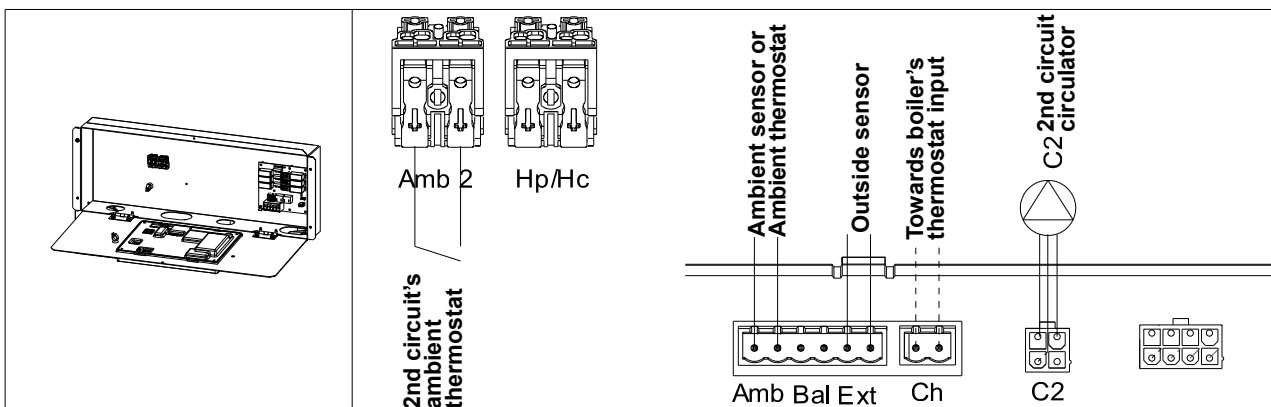

A2.4 - 2 underfloor heating circuits

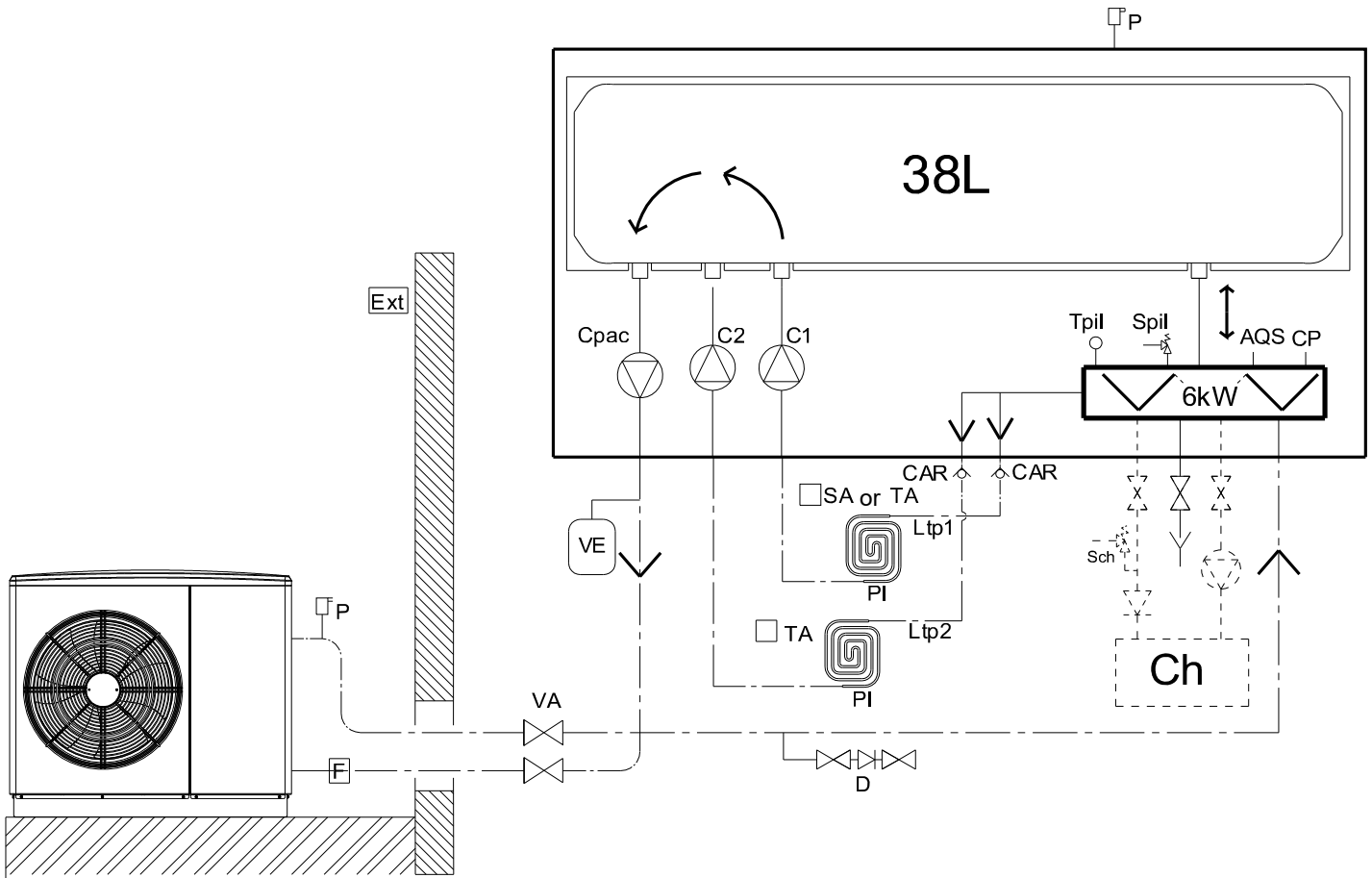

AQS :	Aquastat	P :	Air bleed
CAR :	Non-return valve	PI :	Underfloor heating circuit
Ch :	Boiler back-up (optional)	SA :	Ambient sensor
CP :	Pressure sensor	Sch :	Boiler pressure relief valve
Cpac :	HP circulator	Spil :	Pilot pressure relief valve
C1 :	Circuit 1 circulator	TA :	Ambient thermostat
C2 :	Circuit 2 circulator	TPil :	Pilot sensor (hot water outlet)
D :	Filling valve	VA :	Shut-off valve
Ext :	Outside sensor	Vb :	Sludge flushing valve
F :	Filter Valve	VE :	Expansion vessel
LTP :	OPT - overheat protection thermostat		

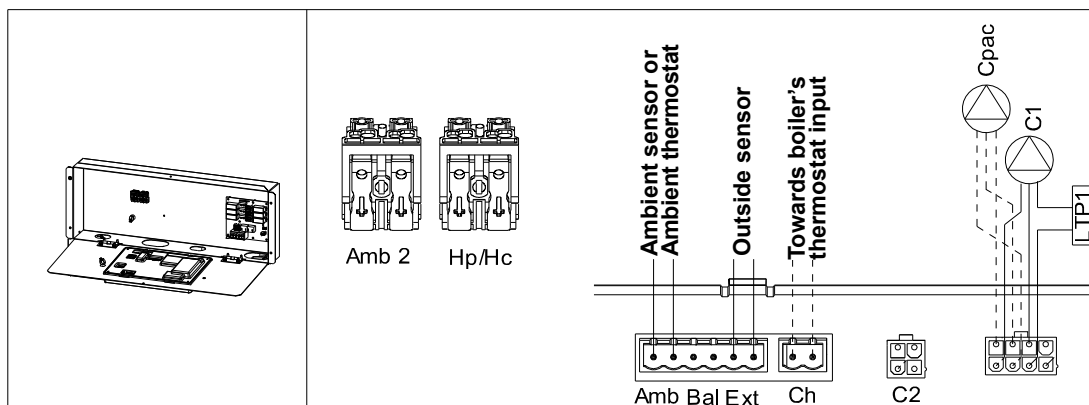

A2.5 - 1 radiators circuit + 1 DHW circuit

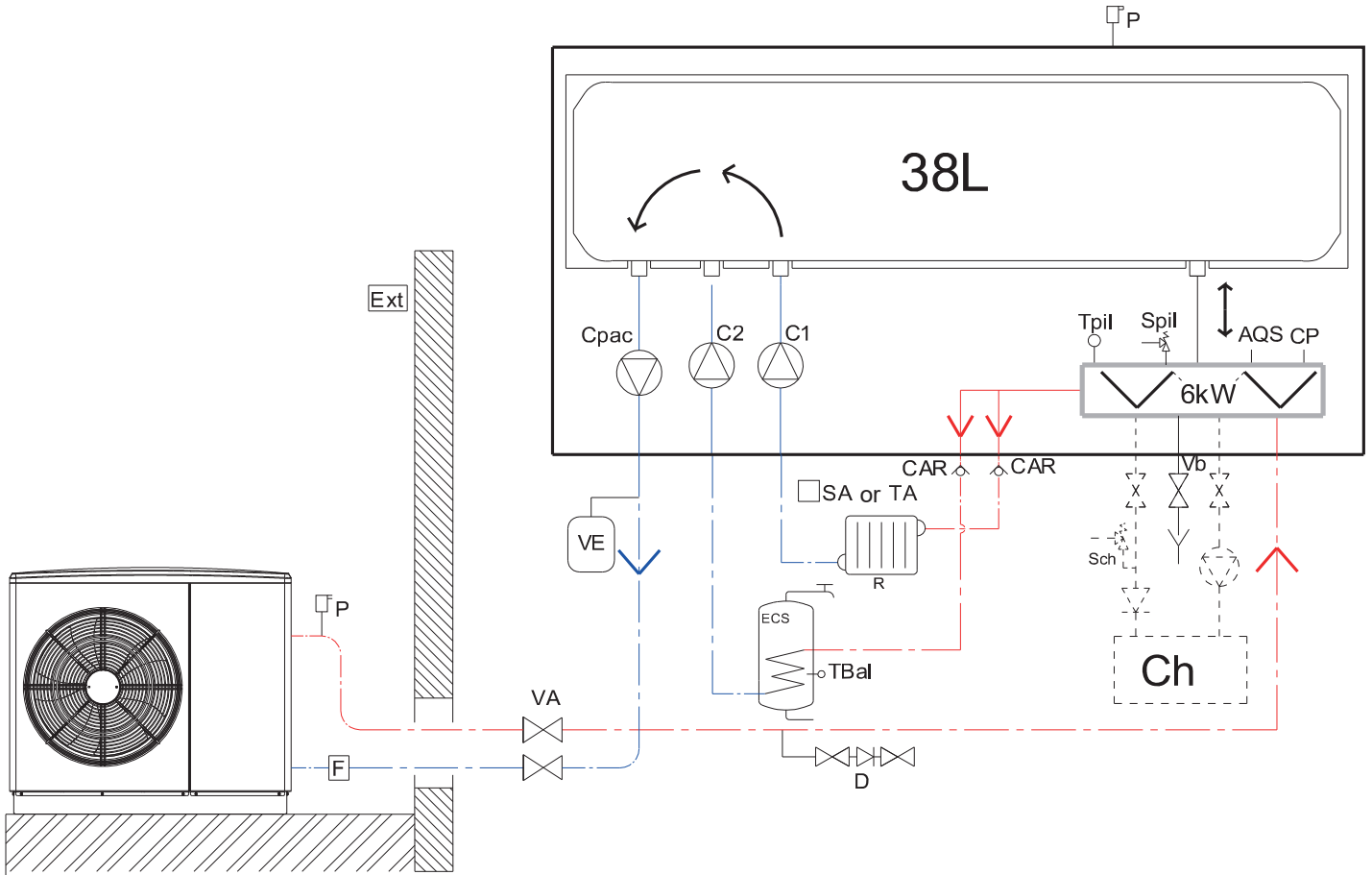

AQS :	Aquastat	P :	Air bleed
CAR :	Non-return valve	R :	Radiators circuit
Ch :	Boiler back-up (optional)	SA :	Ambient sensor
CP :	Pressure sensor	Sch :	Boiler pressure relief valve
Cpac :	HP circulator	Spil :	Pilot pressure relief valve
C1 :	Circuit 1 circulator	TA :	Ambient thermostat
C2 :	Circuit 2 circulator	Tbal :	Tank sensor (sanitary sensor)
D :	Filling valve	Tpil :	Pilot sensor (hot water outlet)
ECS :	DHW tank	VA :	Shut-off valve
Ext :	Outside sensor	Vb :	Sludge flushing valve
F :	Filter Valve	VE :	Expansion vessel

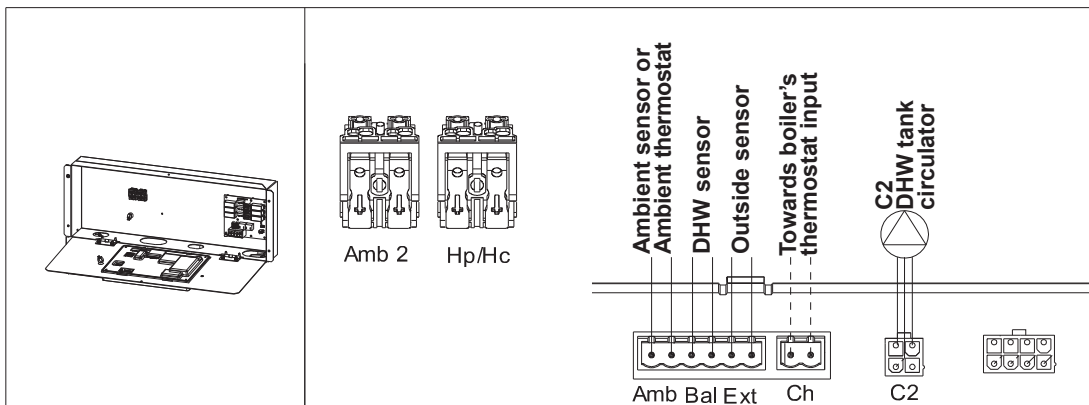

A2.6 - 2 radiators circuits + 1 underfloor heating circuit

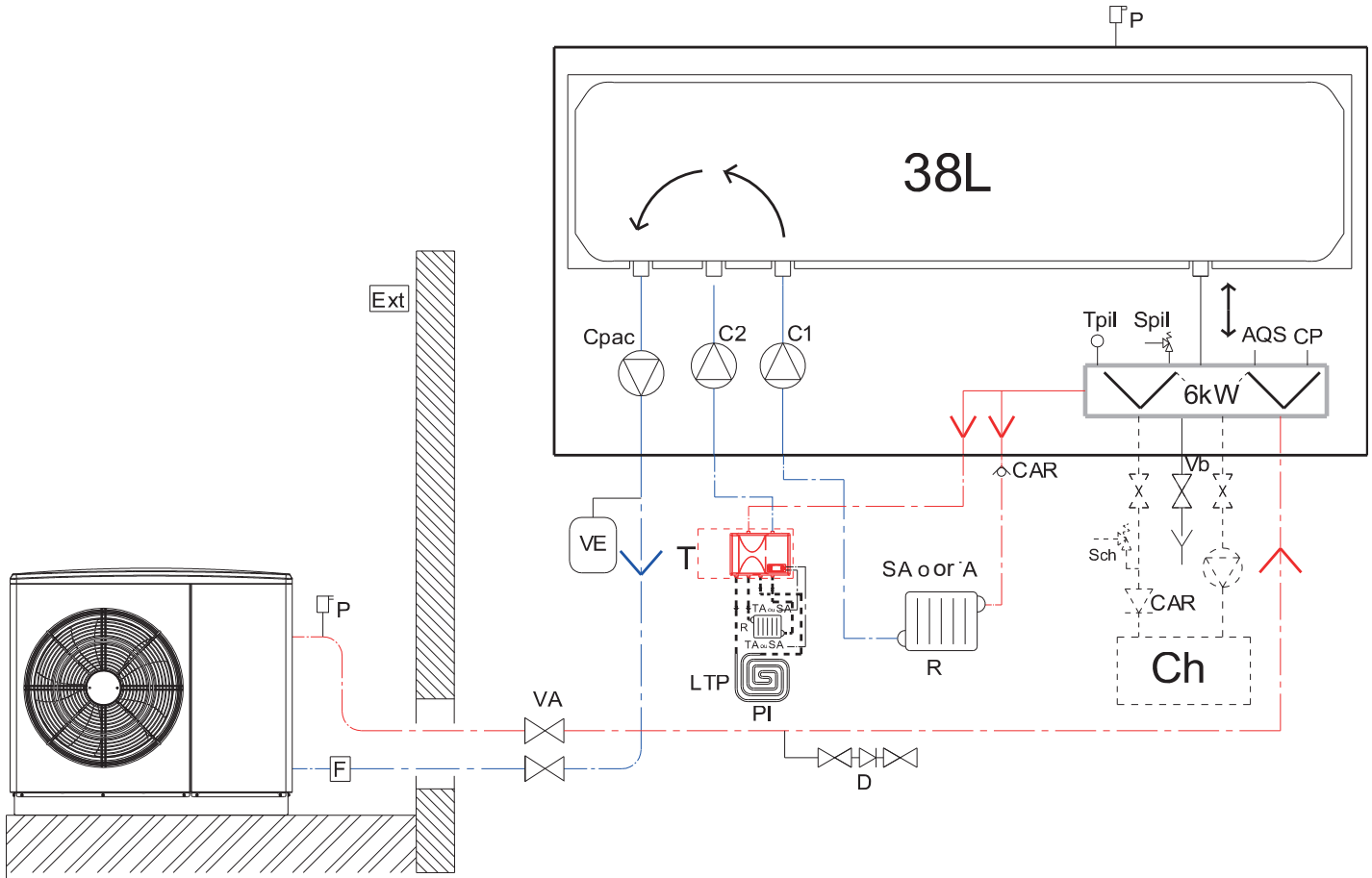

AQS :	Aquastat	P :	Air bleed
CAR :	Non-return valve	R :	Radiators circuit
Ch :	Boiler back-up (optional)	SA :	Ambient sensor
CP :	Pressure sensor	Sch :	Boiler pressure relief valve
Cpac :	HP circulator	SP :	Pilot sensor (hot water outlet)
C1 :	Circuit 1 circulator	T :	Thorix 2C
C2 :	Circuit 2 circulator	TA :	Ambient thermostat
D :	Filling valve	Tpil :	Pilot sensor (hot water outlet)
Ext :	Outside sensor	VA :	Shut-off valve
F :	Filter Valve	Vb :	Sludge flushing valve
LTP :	OPT - Overheat protection thermostat	VE :	Expansion vessel

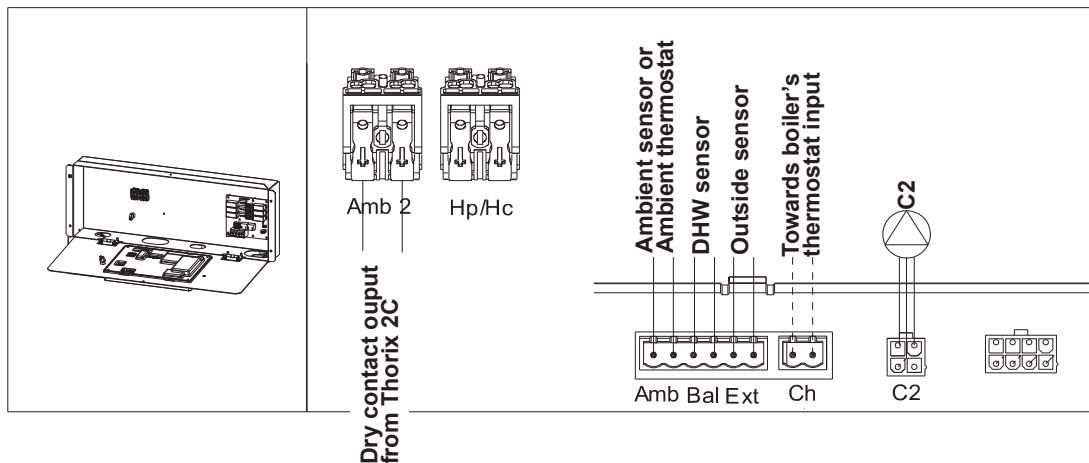

A2.7 - 1 DHW circuit + 1 radiators circuit + 1 underfloor heating circuit

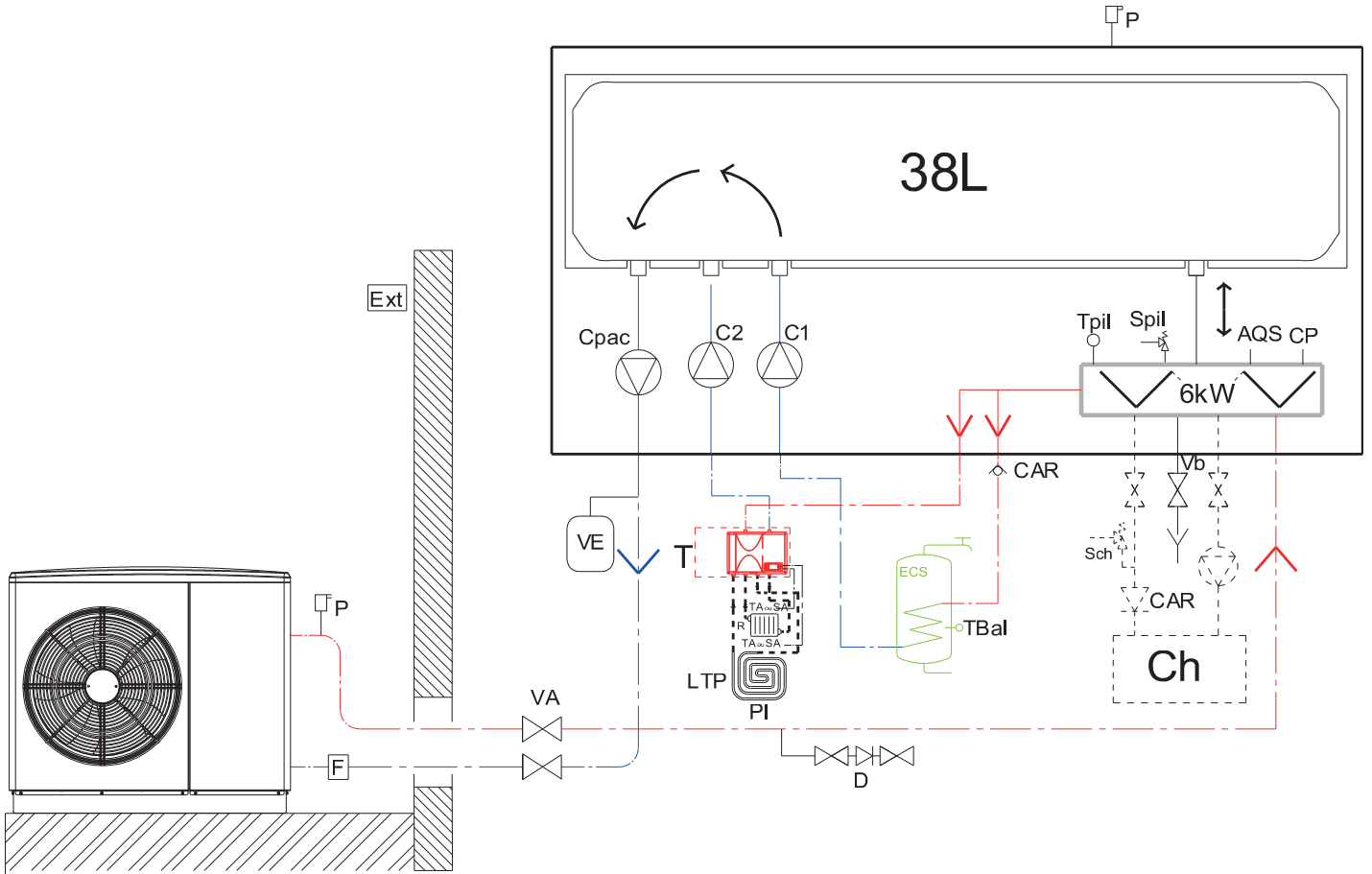

- | | |
|---|---|
| AQS : Aquastat | R : Radiators circuit |
| CAR : Non-return valve | SA : Ambient sensor |
| CP : Pressure sensor | Sch : Boiler pressure relief valve |
| Cpac : HP circulator | SP : Pilot sensor (hot water outlet) |
| C1 : Circuit 1 circulator | T : Thorix 2C |
| C2 : Circuit 2 circulator | TA : Ambient thermostat |
| D : Filling valve | Tpil : Pilot sensor (hot water outlet) |
| Ext : Outside sensor | VA : Shut-off valve |
| F : Filter Valve | Vb : Sludge flushing valve |
| LTP : OPT - Overheat protection thermostat | VE : Expansion vessel |
| P : Air bleed | |

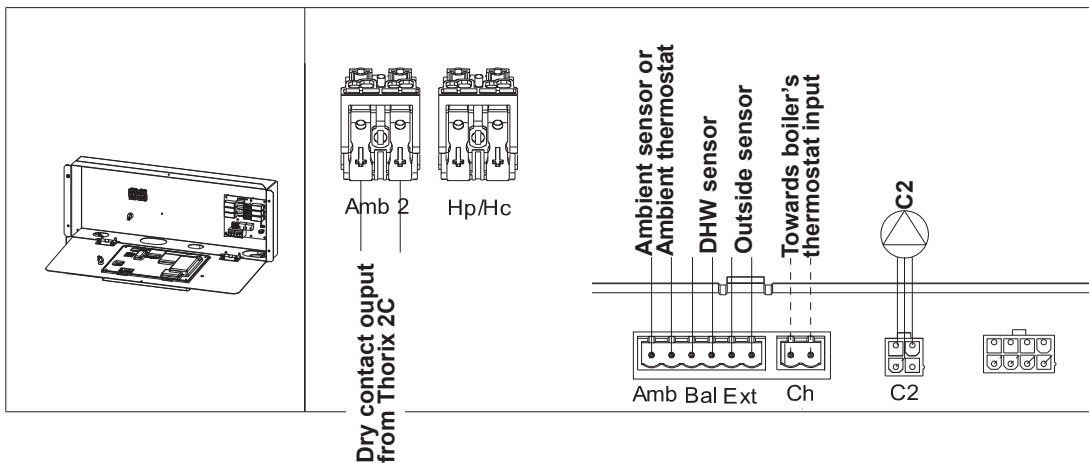

A2.8 - Hydraulic connection between the pilot and the heat pump

	Minimum Ø of piping to respect						
	HTi ⁷⁰ 6 and 8kW	HTi ⁷⁰ 11kW	HTi ⁷⁰ 14kW	HRC ⁷⁰ 5 and 7kW	HRC ⁷⁰ 17	HRC ⁷⁰ 20	HRC ⁷⁰ 25
If distance between HP and Pilot < 10m <i>(the equivalent of 20m linear of loss of load)</i>	22/24	24/26	28/30	22/24	26/28	30/32	34/36
If distance between HP and Pilot > 10m and < 15m <i>(the equivalent of 30m linear of loss of load)</i>	24/26	28/30	32/34	24/26	30/32	34/36	38/40
If distance between HP and Pilot > 15m and < 25m <i>(the equivalent of 50m linear of loss of load)</i>	28/30	32/34	36/38	28/30	32/34	36/38	42/44
If distance between HP and Pilot > 25m et < 50m <i>(the equivalent of 100m linear of loss of load)</i>	32/34	36/38	42/44	32/34	38/40	42/44	48/50

A2.9 - Minimum flow rate to respect depending on the heat pump model

Heat pump model	HTi ⁷⁰				HRC ⁷⁰				
	6 kW	8 kW	11 kW	14 kW	5 kW	7 kW	17 kW	20 kW	25 kW
Nominal output									
Minimum nominal flow rate	1050 L/h	1350L/h	1550 L/h	2000 L/h	1000 L/h	1350 L/h	2000 L/h	2450 L/h	3000 L/h
Maximum pressure	2.5 bar	2.5 bar	2,5 bar	2,5 bar	2,5 bar	2,5 bar	2,5 bar	2,5 bar	2,5 bar

A3 - Wiring diagrams

A3.1 - PREMIUM+ pilot: wiring diagram with electrical back-up or boiler back-up

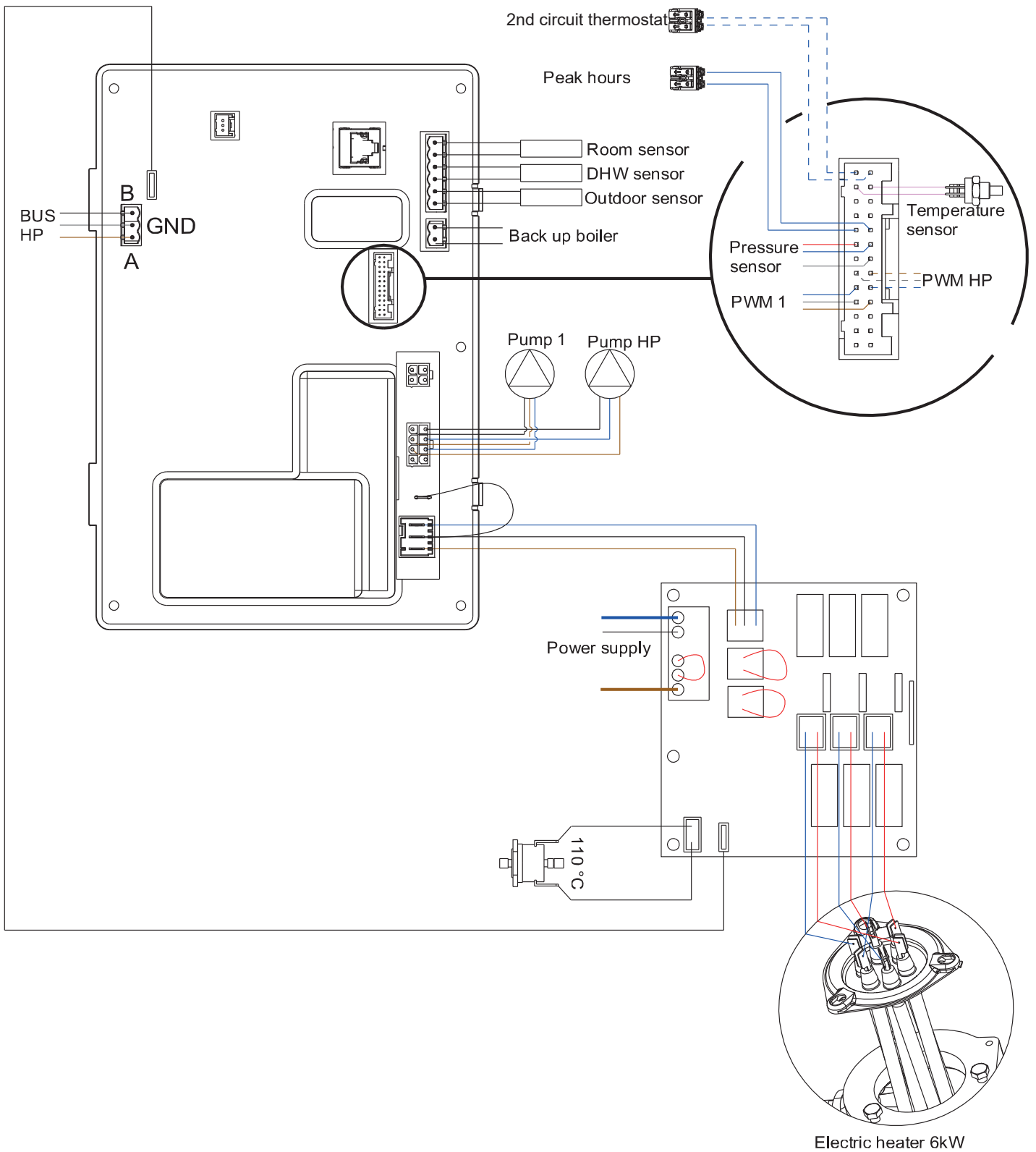

* Dry contact to connect on the ambient thermostat input of the boiler

It's not necessary to disconnect the electrical back-up if the boiler back-up is declared.

A4 - Recap of functions

A4.1 - Control panel

A4.1.1 - Keypad

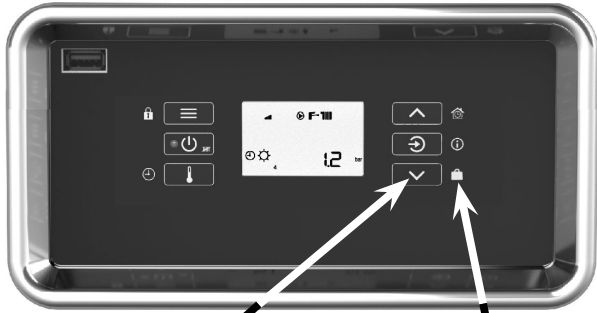

Button Primary function
ex.: decrease / scroll down

Secondary function
ex.: holiday mode

Primary function (short press)	Secondary function (long press)
- menu access - return / cancel	locking / unlocking of the keypad
- on / off	standby mode
- setting the temperatures	program scheduled comfort modes
- increase the setting - scroll up	activate temporary comfort mode
- confirm / remove error - display pressure or T°	information on temperatures and current operating state
- decrease the setting - scroll down	activation of holiday mode

A4.1.2 - Display

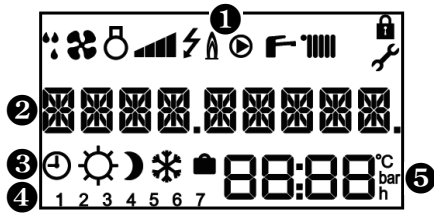

1 Symbols of current operating state

	defrosting in progress		circulating pump working
	ventilator working		domestic hot water activated
	compressor working		heating activated
	power level		keypad locked
	electrical back-up		installer menu
	back-up boiler		

2 9 character message





3 Current comfort mode

	Programming active		Comfort mode		Eco mode
	Frost protection mode		Holiday mode		

4 Day of the week: (1= Monday; 2= Tuesday...)





5 Display zone: temperatures, pressure, settings, time...

A4.2 - Menus

Menus (and sub-menus)	access buttons
menu USER	
menu INSTALLER	
- CIRC.PUMP : Setting the speed of heating circulating pump	
- OUTS.TMAX : Outside temperature on the warmest day	
- OUTS.TMIN : Outside temperature on the coldest day	
- BACKUP : Choice of back-up	
- HEAT CURV 1 : Setting the heat curve 1	
- HEAT TMAX. : Heat curve 1 setpoint on the coldest day	
- HEAT TMIN : Heat curve 1 setpoint on the warmest day	+
- HEAT CURV 2 : Setting the heat curve 2	
- TMAX HEAT 2 : Heat curve 2 setpoint on the coldest day	
- TMIN HEAT 2 : Heat curve 2 setpoint on the warmest day	
- SHARING : Activation of priority sharing	
- ANTI_BACT : Activation of anti-bacteria function	
- HP CIRC : Setting the speed of HP circulating pump	
menu EXPERT	
- SETTINGS : Access to all parameters	
- DISPLAY : State of operation of the pilot	
- DATA CALC : Temperatures and time delays in progress	
- COUNTERS : Operation counters	
- CONFIGURA. : Choice of circuits and their controls	+
- AIR BLEED : Activation of a special air purge cycle	
- MANUAL : Manual operation of component for diagnostics	
- COMMISSIO: Access to the set-up	
- MODBUS : Remote control setting up	
- SOFTWARE : Manage software version	

Press  to exit the menus and sub-menus.

A4.3- Actions to be activated using a combination of buttons

Action	combination of buttons
<u>Reset counters to zero</u> Certain counters cannot be reset to zero. Only the counters which can be reset are affected by this action.	in the «counters» menu  +  press for 5s
<u>Reset to default settings</u> (return to factory settings)	in the «settings» menu  +  press for 5s



Industrial and development site

Rue de la République
CS 40029
80210 Feuquières-en-Vimeu

Spare parts department

Tel. : 03 22 61 21 21
Fax : 03 22 61 33 35
E-mail : pieces@auer.fr

Technical assistance department*

E-mail : enr@auer.fr

**Technical assistance is reserved for professionalss*