

AIR CONDITIONER

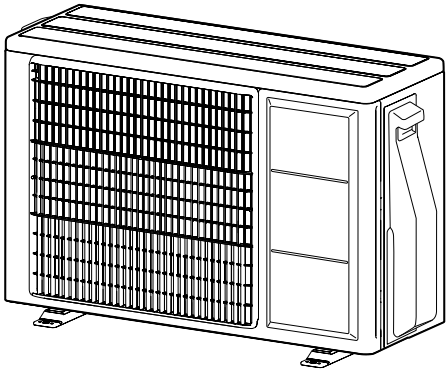

INSTALLATION MANUAL

OUTDOOR UNIT

For authorized service personnel only.

English

INSTALLATIONSANLEITUNG

AUSSENGERÄT

Nur für autorisiertes Fachpersonal.

Deutsch

MANUEL D'INSTALLATION

UNITÉ EXTÉRIEUR

Pour le personnel de service agréé uniquement.

Français

MANUAL DE INSTALACIÓN

UNIDAD EXTERIOR

Únicamente para personal de servicio autorizado.

Español

MANUALE D'INSTALLAZIONE

UNITÀ ESTERNA

A uso esclusivo del personale tecnico autorizzato.

Italiano

ΕΓΧΕΙΡΙΔΙΟ ΕΓΚΑΤΑΣΤΑΣΗΣ

ΕΞΩΤΕΡΙΚΗ ΜΟΝΑΔΑ

Μόνο για εξουσιοδοτημένο τεχνικό προσωπικό.

Ελληνικά

MANUAL DE INSTALAÇÃO

UNIDADE EXTERIOR

Somente para o pessoal do serviço técnico autorizado.

Português

РУКОВОДСТВО ПО УСТАНОВКЕ

ВНЕШНИЙ МОДУЛЬ

Только для авторизованного обслуживающего персонала.

Русский

KURULUM KILAVUZU

DIŞ ÜNİTE

Yalnızca yetkili servis personeli için.

Türkçe

[Original instructions]



PART No. 9319205175

Contents

1. SAFETY PRECAUTIONS.....	1
2. ABOUT THE UNIT.....	2
2.1. Special tools for R410A.....	2
2.2. Accessories.....	2
3. GENERAL SPECIFICATION.....	2
3.1. Selecting circuit breaker and wiring.....	2
3.2. Selecting the pipe material.....	2
3.3. Protection of pipes.....	2
3.4. Refrigerant pipe size and allowable piping length.....	2
3.5. Additional charge.....	3
4. INSTALLATION WORK.....	3
4.1. Selecting an installation location.....	3
4.2. Drain installation.....	3
4.3. Installation dimensions.....	3
4.4. Installation.....	4
5. OUTDOOR UNIT INSTALLATION.....	5
5.1. Switch cover removal.....	5
5.2. Notes for electrical wiring.....	5
5.3. Wiring method.....	6
5.4. Pipe connection.....	6
5.5. Sealing test.....	7
5.6. Vacuum process.....	7
5.7. Installing insulation.....	7
6. TEST RUN.....	7

1. SAFETY PRECAUTIONS

Be sure to read this manual carefully before installation.

The warnings and precautions indicated in this manual contain important information pertaining to your safety. Be sure to observe them.

Hand this manual, together with the operating manual, to the customer. Request the customer to keep them on hand for future use, such as for relocating or repairing the unit.

 WARNING	Indicates a potentially or imminently hazardous situation which, if not avoided, could result in death or serious injury.
Installation of this product must be done by experienced service technicians or professional installers only in accordance with this manual. Installation by nonprofessional or improper installation of the product may cause serious accidents such as injury, water leakage, electric shock, or fire. If the product is installed in disregard of the instructions in this manual, it will void the manufacturer's warranty.	
To avoid getting an electric shock, never touch the electrical components soon after the power supply has been turned off. After turning off the power, always wait 10 minutes or more before you touch the electrical components.	
Do not turn on the power until all work has been completed. Turning on the power before the work is completed can cause serious accidents such as electric shock or fire.	
If refrigerant leaks while work is being carried out, ventilate the area. If the refrigerant comes in contact with a flame, it produces a toxic gas.	
Installation must be performed in accordance with regulations, codes, or standards for electrical wiring and equipment in each country, region, or the installation place.	
Do not use this equipment with air or any other unspecified refrigerant in the refrigerant lines. Excess pressure can cause a rupture.	
During installation, make sure that the refrigerant pipe is attached firmly before you run the compressor. Do not operate the compressor under the condition of refrigerant piping not attached properly with 3-way valve open. This may cause abnormal pressure in the refrigeration cycle that leads to rupture and even injury.	
When installing or relocating the air conditioner, do not mix gases other than the specified refrigerant (R410A) to enter the refrigerant cycle. If air or other gas enters the refrigerant cycle, the pressure inside the cycle will rise to an abnormally high value and cause rupture, injury, etc.	

 WARNING	Indicates a potentially or imminently hazardous situation which, if not avoided, could result in death or serious injury.
To connect the indoor unit and outdoor unit, use air conditioner piping and cables available locally as standard parts. This manual describes proper connections using such installation set.	
Do not modify power cable, use extension cable or branch wiring. Improper use may cause electric shock or fire by poor connection, insufficient insulation or over current.	
Do not purge the air with refrigerants but use a vacuum pump to vacuum the installation.	
There is not extra refrigerant in the outdoor unit for air purging.	
Use a vacuum pump for R410A exclusively.	
Using the same vacuum pump for different refrigerants may damage the vacuum pump or the unit.	
Use a clean gauge manifold and charging hose for R410A exclusively.	
During the pump-down operation, make sure that the compressor is turned off before you remove the refrigerant piping. Do not remove the connection pipe while the compressor is in operation with 3-way valve open. This may cause abnormal pressure in the refrigeration cycle that leads to rupture and even injury.	
This appliance is not intended for use by persons (including children) with reduced physical, sensory or mental capabilities, or lack of experience and knowledge, unless they have been given supervision or instruction concerning use of the appliance by a person responsible for their safety. Children should be supervised to ensure that they do not play with the appliance.	
To avoid danger of suffocation, keep the plastic bag or thin film used as the packaging material away from young children.	

 CAUTION	Indicates a potentially hazardous situation that may result in minor or moderate injury or damage to property.
For the air conditioner to work appropriately, install it as written in this manual.	
This product must be installed by qualified personnel with a capacity certification of handling refrigerant fluids. Refer to regulation and laws in use on installation place.	
Install the product by following local codes and regulations in force at the place of installation, and the instructions provided by the manufacturer.	
This product is part of a set constituting an air conditioner. The product must not be installed alone or be installed with non-authorized device by the manufacturer.	
Always use a separate power supply line protected by a circuit breaker operating on all wires with a distance between contact of 3 mm for this product.	
To protect the persons, earth (ground) the product correctly, and use the power cable combined with an Earth Leakage Circuit Breaker (ELCB).	
This product is not explosion proof, and therefore should not be installed in explosive atmosphere.	
This product contains no user-serviceable parts. Always consult experienced service technicians for repairing.	
When moving or relocating the air conditioner, consult experienced service technicians for disconnection and reinstallation of the product.	
Do not touch the fins of the heat exchanger. Touching the heat exchanger fins could result in damage to the fins or personal injury such as skin rupture.	
Do not place any other electrical products or household belongings under the product. Condensation dripping from the product might get them wet, and may cause damage or malfunction to the property.	

Precautions for using R410A refrigerant

 WARNING
Do not touch refrigerant that has leaked from the refrigerant pipe connections or other areas. Touching the refrigerant directly can cause frostbite.
If a refrigerant leak occurs during operation, immediately vacate the premises and thoroughly ventilate the area. If the refrigerant comes in contact with a flame, it produces a toxic gas.
The basic installation work procedures are the same as conventional refrigerant models. However, pay careful attention to the following points:
<ul style="list-style-type: none"> • Since the working pressure is 1.6 times higher than that of conventional refrigerant (R22) models, some of the piping and installation and service tools are special. Especially, when replacing a conventional refrigerant (R22) model with a new refrigerant R410A model, always replace the conventional piping and flare nuts with the R410A piping and flare nuts. • Models that use refrigerant R410A have a different charging port thread diameter to prevent erroneous charging with conventional refrigerant (R22) and for safety. Therefore, check beforehand. [The charging port thread diameter for R410A is 1/2-20 UNF.] • Be careful that foreign matter (oil, water, etc.) does not enter the piping than with refrigerant models. Also, when storing the piping, securely seal the openings by pinching, taping, etc. • When charging the refrigerant, take into account the slight change in the composition of the gas and liquid phases. And always charge from the liquid phase where refrigerant composition is stable.

2. ABOUT THE UNIT

2.1. Special tools for R410A

⚠ WARNING

To install a unit that uses R410A refrigerant, use dedicated tools and piping materials that have been manufactured specifically for R410A use. Because the pressure of R410A refrigerant is approximately 1.6 times higher than R22, failure to use dedicated piping material or improper installation can cause rupture or injury. Furthermore, it can cause serious accidents such as water leakage, electric shock, or fire.

Tool name	Contents of change
Gauge manifold	Pressure is high and cannot be measured with a conventional gauge. To prevent erroneous mixing of other refrigerants, the diameter of each port has been changed. It is recommended the gauge with seals -0.1 to 5.3 MPa (-1 to 53 bar) for high pressure. -0.1 to 3.8 MPa (-1 to 38 bar) for low pressure.
Charge hose	To increase pressure resistance, the hose material and base size were changed.
Vacuum pump	A conventional vacuum pump can be used by installing a vacuum pump adapter.
Gas leakage detector	Special gas leakage detector for HFC refrigerant R410A.

Copper pipes



It is necessary to use seamless copper pipes and it is desirable that the amount of residual oil is less than 40 mg/10 m. Do not use copper pipes having a collapsed, deformed or discolored portion (especially on the interior surface). Otherwise, the expansion valve or capillary tube may become blocked with contaminants. As an air conditioner using R410A incurs pressure higher than when using conventional refrigerant, it is necessary to choose adequate materials.

2.2. Accessories

⚠ WARNING

For installation purposes, be sure to use the parts supplied by the manufacturer or other prescribed parts. The use of non-prescribed parts can cause serious accidents such as the unit falling, water leakage, electric shock, or fire.

- The following installation parts are supplied. Use them as required.
- Keep the Installation Manual in a safe place and do not discard any other accessories until the installation work has been completed.

Name and shape	Q'ty	Description
Installation Manual 	1	This manual
Drain pipe 	1	For outdoor unit drain piping work (May not be supplied, depending on the model.)

3. GENERAL SPECIFICATION

3.1. Selecting circuit breaker and wiring

⚠ CAUTION

Be sure to install a breaker of the specified capacity.
Regulation of cables and breaker differs from each locality, refer in accordance with local rules.

Voltage rating	1 Φ 230 V (50 Hz)
Operating range	198 to 264 V

Cable	Conductor size [mm ²] ¹	Type	Remarks
Power Supply Cable	Min. 2.5	Type60245 IEC57	2 wire + Ground 1 Φ 230 V
Connection Cable	Min. 1.5	Type60245 IEC57	3 wire + Ground 1 Φ 230 V

¹ Selected sample: Select the correct cable type and size according to the country or region's regulations.

* Limit the voltage drop less than 2 %. Increase the cable diameter if voltage drop is 2 % or more.

Breaker capacity [A]	Earth leakage breaker [mA]
20	30

- Select the breaker that enough load current can pass through it.
- Before starting work check that power is not being supplied to all poles of the indoor unit and outdoor unit.
- Install all electrical works in accordance to standard.
- Install the disconnect device with a contact gap of at least 3 mm in all poles nearby the units. (Both indoor unit and outdoor unit)

3.2. Selecting the pipe material

⚠ CAUTION

Do not use existing pipes.

Use pipes that have clean external and internal sides without any contamination which may cause trouble during use, such as sulfur, oxide, dust, cutting waste, oil, or water.

It is necessary to use seamless copper pipes.

Material: Phosphor deoxidized seamless copper pipes.

It is desirable that the amount of residual oil is less than 40 mg/10 m.

Do not use copper pipes that have a collapsed, deformed, or discolored portion (especially on the interior surface). Otherwise, the expansion valve or capillary tube may become blocked with contaminants.

Improper pipe selection will degrade performance. As an air conditioner using R410A incurs pressure higher than when using conventional refrigerant, it is necessary to choose adequate materials.

- Thicknesses of copper pipes used with R410A are as shown in the table.
- Never use copper pipes thinner than those indicated in the table even if they are available on the market.

Thicknesses of Annealed Copper Pipes

Pipe outside diameter [mm (in.)]	Thickness [mm]
6.35 (1/4)	0.80
9.52 (3/8)	0.80
12.70 (1/2)	0.80
15.88 (5/8)	1.00
19.05 (3/4)	1.20

3.3. Protection of pipes

- Protect the pipes to prevent the entry of moisture and dust.
- Especially, pay attention when passing the pipes through a hole or connecting the end of a pipe to the outdoor unit.

Location	Working period	Protection method
Outdoor	1 month or more	Pinch pipes
	Less than 1 month	Pinch or tape pipes
Indoor	-	Pinch or tape pipes

3.4. Refrigerant pipe size and allowable piping length

⚠ CAUTION

Keep the piping length between the indoor unit and outdoor unit within the allowable tolerance.

The maximum lengths of this product are shown in the table. If the units are further apart than this, correct operation cannot be guaranteed.

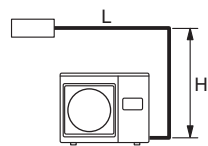
	18 model	24 model
Pipe diameter	Liquid [mm (in.)]	6.35 (1/4)
	Gas [mm (in.)]	12.70 (1/2)
Max. piping length (L) [m]	25	30
Max. height difference (H) <Indoor unit to outdoor unit> [m]	15	20
View (Example)		

3.5. Additional charge

CAUTION

When adding refrigerant, add the refrigerant from the charging port at the completion of work.

The maximum length of the piping is 25 m (18 model) or 30 m (24 model). If the units are further apart than this, correct operation cannot be guaranteed.

Refrigerant suitable for a piping length of 15 m is charged in the outdoor unit at the factory. When the piping is longer than 15 m, additional charging is necessary. For the additional amount, see the following table.

Pipe length		15 m	20 m	25 m	30 m	Rate
Additional refrigerant	18 model	None	+100 g	+200 g	—	
	24 model	None	+100 g	+200 g	+300 g	

Between 15 m and 20 m, when using a connection pipe other than that in the table, charge additional refrigerant with 20 g/m as the criteria.

4. INSTALLATION WORK

Make sure to obtain the customer's approval for selecting and installing the outdoor unit.

4.1. Selecting an installation location

WARNING

Securely install the outdoor unit at a location that can withstand the weight of the unit. Otherwise, the outdoor unit may fall and cause injury.

Be sure to install the outdoor unit as prescribed, so that it can withstand earthquakes and typhoons or other strong winds. Improper installation can cause the unit to topple or fall, or other accidents.

Do not install the outdoor unit near the edge of a balcony. Otherwise, children may climb onto the outdoor unit and fall off of the balcony.

CAUTION

Do not install the outdoor unit in the following areas:

- Area with high salt content, such as at the seaside. It will deteriorate metal parts, causing the parts to fail or the unit to leak water.
- Area filled with mineral oil or containing a large amount of splashed oil or steam, such as a kitchen. It will deteriorate plastic parts, causing the parts to fail or the unit to leak water.
- Area that generates substances that adversely affect the equipment, such as sulfuric gas, chlorine gas, acid, or alkali. It will cause the copper pipes and brazed joints to corrode, which can cause refrigerant leakage.
- Area containing equipment that generates electromagnetic interference. It will cause the control system to malfunction, preventing the unit from operating normally.
- Area that can cause combustible gas to leak, contains suspended carbon fibers or flammable dust, or volatile inflammables such as paint thinner or gasoline. If gas leaks and settles around the unit, it can cause a fire.
- Area that has heat sources, vapors, or the risk of the leakage of flammable gas in the vicinity.
- Area where small animals may live. It may cause failure, smoke or fire if small animals enter and touch internal electrical parts.
- Area where animals may urinate on the unit or ammonia may be generated.

Do not tilt the outdoor unit more than 3 degrees. However, do not install the unit with it tilted towards the side containing the compressor.

Install the outdoor unit in a well-ventilated location away from rain or direct sunlight.

If the outdoor unit must be installed in an area within easy reach of the general public, install as necessary a protective fence or the like to prevent their access.

Install the outdoor unit in a location that would not inconvenience your neighbors, as they could be affected by the airflow coming out from the outlet, noise, or vibration. If it must be installed in proximity to your neighbors, be sure to obtain their approval.

If the outdoor unit is installed in a cold region that is affected by snow accumulation, snow fall, or freezing, take appropriate measures to protect it from those elements. To ensure a stable operation, install inlet and outlet ducts.

Install the outdoor unit in a location that is away from exhaust or the vent ports that discharge vapor, soot, dust, or debris.

Install the indoor unit, outdoor unit, power supply cable, connection cable, and remote controller cable at least 1 m away from a television or radio receivers. The purpose of this is to prevent TV reception interference or radio noise. (Even if they are installed more than 1 m apart, you could still receive noise under some signal conditions.)

If children under 10 years old may approach the unit, take preventive measures so that they cannot reach the unit.

Keep the length of the piping of the indoor and outdoor units within the allowable range.

For maintenance purposes, do not bury the piping.

Decide the mounting position with the customer as follows:

- (1) Install the outdoor unit in a location which can withstand the weight of the unit and vibration, and which can install horizontally.
- (2) Provide the indicated space to ensure good airflow.
- (3) If possible, do not install the unit where it will be exposed to direct sunlight. (If necessary, install a blind that does not interfere with the airflow.)
- (4) Do not install the unit near a source of heat, steam, or flammable gas.
- (5) During heating operation, drain water flows from the outdoor unit. Therefore, install the outdoor unit in a place where the drain water flow will not be obstructed.
- (6) Do not install the unit where strong wind blows or where it is very dusty.
- (7) Do not install the unit where people pass.
- (8) Install the outdoor unit in a place where it will be free from being dirty or getting wet by rain as much as possible.
- (9) Install the unit where connection to the indoor unit is easy.

4.2. Drain installation

CAUTION

Perform drain work in accordance with this Manual, and ensure that the drain water is properly drained. If the drain work is not carried out correctly, water may drip down from the unit, wetting the furniture.

When the outdoor temperature is 0 °C or less, do not use the accessory drain pipe. If the drain pipe is used, the drain water in the pipe may freeze in extremely cold weather.

Since the drain water flows out of the outdoor unit during heating operation, install the drain pipe and connect it to a commercial 16 mm hose.

When installing the drain pipe, plug all the holes other than the drain pipe mounting hole in the bottom of the outdoor unit with putty so there is no water leakage.

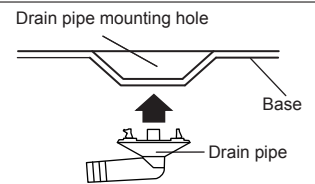

(Unit : mm)

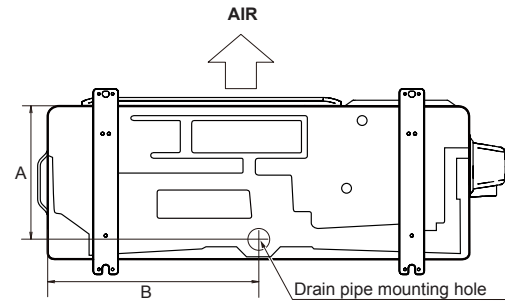

	Dimensions	
	A	B
18 model	252	399
24 model	277	409

4.3. Installation dimensions

CAUTION

Keep the space shown in the installation examples.

If the installation is not performed accordingly, it could cause a short circuit and result in a lack of operating performance.

4.3.1. Outdoor unit installation

When the upper space is open (Unit : mm)

(1) Obstacles at rear only

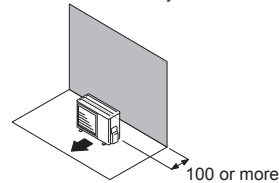

(2) Obstacles at rear and sides

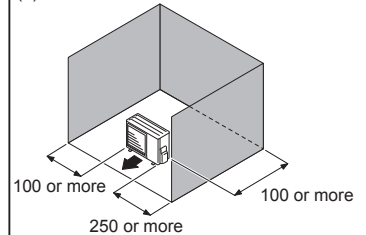

(3) Obstacles at front

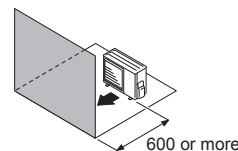

(4) Obstacles at front and rear

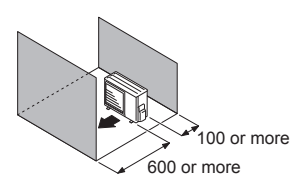

When an obstruction in the upper space (Unit : mm)

(1) Obstacles at rear and above

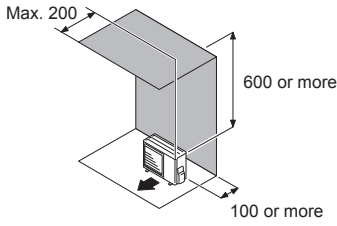

(2) Obstacles at rear, sides, and above

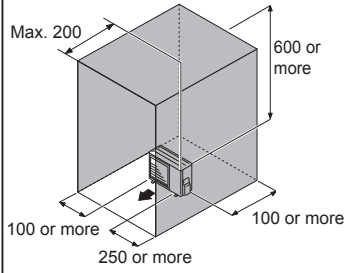

4.3.2. Multiple outdoor unit installation

- Provide at least 250 mm of space between the outdoor units if multiple units are installed.
- When routing the piping from the side of an outdoor unit, provide space for the piping.
- No more than 3 units must be installed side by side.

When 3 units or more are arranged in a line, provide the space as shown in the following example when an obstruction in the upper space.

When the upper space is open (Unit : mm)

(1) Obstacles at rear only

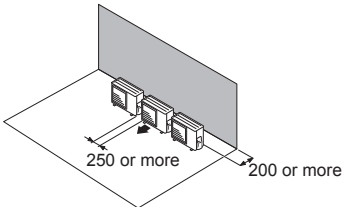

(2) Obstacles at front only

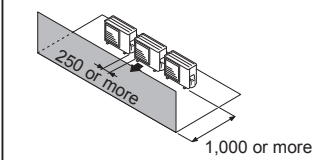

(3) Obstacles at front and rear

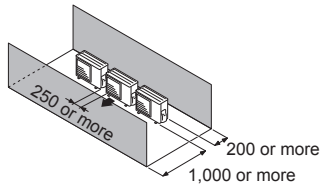

When an obstruction in the upper space (Unit : mm)

Obstacles at rear and above

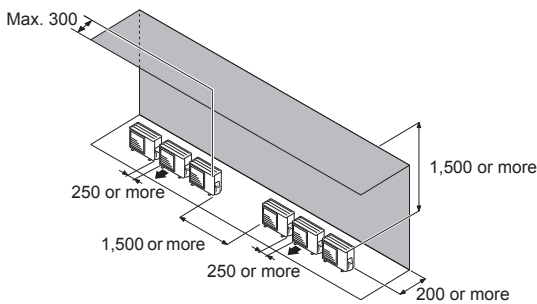

4.3.3. Outdoor units installation multi-row (Unit : mm)

(1) Single parallel unit arrangement

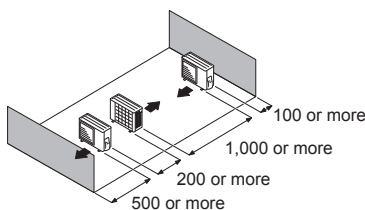

(2) Multiple parallel unit arrangement

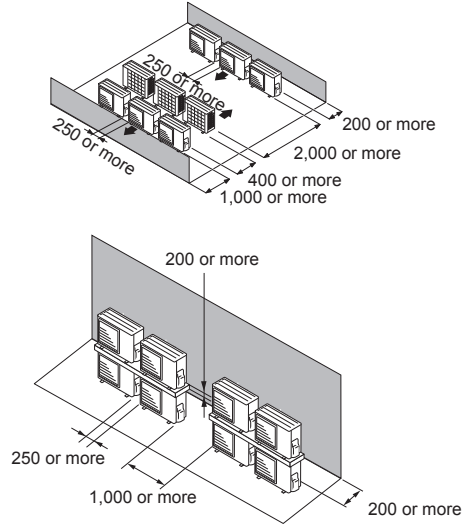

NOTES:

- If the space is larger than stated above, the condition will be the same as when there is no obstacle.
- When installing the outdoor unit, be sure to open the front and left side to obtain better operation efficiency.

4.4. Installation

- Install 4 anchor bolts at the locations indicated with arrows in the figure.
- To reduce vibration, do not install the unit directly on the ground. Install it on a secure base (such as concrete blocks).
- The foundation shall support the legs of the unit and have a width of 50 mm or more.
- Depending on the installation conditions, the outdoor unit may spread its vibration during operation, which may cause noise and vibration. Therefore, attach damping materials (such as damping pads) to the outdoor unit during installation.
- Install the foundation, making sure that there is enough space for installing the connection pipes.
- Secure the unit to a solid block using foundation bolts. (Use 4 sets of commercially available M10 bolts, nuts, and washers.)
- The bolts should protrude 20 mm. (Refer to the figure.)
- If overturning prevention is required, purchase the necessary commercially available items.

(Unit : mm)

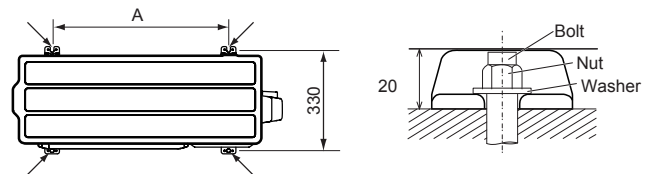

	Dimensions	
	A	
18 model	580	
24 model	600	

CAUTION

Do not install the outdoor unit in two-stage where the drain water could freeze. Otherwise the drainage from the upper unit may form ice and cause a malfunction of the lower unit. When the outdoor temperature is 0 °C or less, do not use the accessory drain pipe. If the drain pipe is used, the drain water in the pipe may freeze in extremely cold climate.

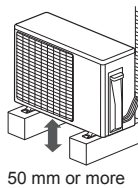

If the unit is installed in a region that is exposed to high winds, freezing conditions, freezing rain, snow fall or heavy snow accumulation, take appropriate measures to protect it from those elements. To ensure stable operation, the outdoor unit must be installed on a raised stand or rack, at or above the anticipated snow depth for the region. The installation of snow hoods and drift prevention fencing is recommended when blowing and drifting snow is common to the region.

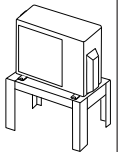

5. OUTDOOR UNIT INSTALLATION

5.1. Switch cover removal

Switch cover removal

- (1) Remove the tapping screws. (3 places)
- (2) Slide the switch cover downwards to release.

Installing the switch cover

- (1) After inserting the hooks (2 places) on the switch cover into the hole on the outdoor unit, slide the switch cover upwards.
- (2) Replace the tapping screws. (3 places).

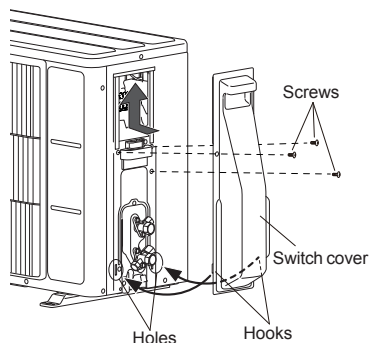

5.2. Notes for electrical wiring

⚠ WARNING

Wiring connections must be performed by a qualified person in accordance with the specifications. The voltage rating for this product is 230 V at 50 Hz. It should be operated within the range of 198 to 264 V.

Before connecting the wires, make sure the power supply is off.

Never touch electrical components immediately after the power supply has been turned off. Electrical shock may occur. After turning off the power, always wait 10 minutes or more before touching electrical components.

Use a dedicated power supply circuit. Insufficient power capacity in the electrical circuit or improper wiring may cause electric shock or fire.

Be sure to install an earth leakage breaker. Otherwise, it will cause electric shock or fire.

A circuit breaker is installed in the permanent wiring. Always use a circuit that can trip all the poles of the wiring and has an isolation distance of at least 3 mm between the contacts of each pole.

Use designated cables and power cables. Improper use may cause electric shock or fire by poor connection, insufficient insulation, or over current.

Do not modify power cable, use extension cable or branch wiring. Improper use may cause electric shock or fire by poor connection, insufficient insulation or over current.

Connect the connector cable securely to the terminal. Check no mechanical force bears on the cables connected to the terminals. Faulty installation can cause a fire.

Use ring terminals and tighten the terminal screws to the specified torques, otherwise, abnormal overheating may be produced and possibly cause serious damage inside the unit.

Make sure to secure the insulation portion of the connector cable with the cable clamp. Damaged insulation can cause a short circuit.

Fix cables so that cables do not make contact with the pipes (especially on high pressure side). Do not make power supply cable and transmission cable come in contact with valves (Gas).

Never install a power factor improvement condenser. Instead of improving the power factor, the condenser may overheat.

Be sure to perform the grounding work. Do not connect grounding wires to a gas pipe, water pipe, lightning rod or grounding wire for a telephone.

- Connection to a gas pipe may cause a fire or explosion if gas leaks.
- Connection to a water pipe is not an effective grounding method if PVC pipe is used.
- Connection to the grounding wire of a telephone or to a lightning rod may cause a dangerously abnormal rise in the electrical potential if lightning strikes.
- Improper grounding work can cause electric shocks.

Securely install the electrical box cover on the unit. An improperly installed service panel can cause serious accidents such as electric shock or fire through exposure to dust or water.

Do not connect the AC power supply to the transmission line terminal board. Improper wiring can damage the entire system.

⚠ CAUTION

The primary power supply capacity is for the air conditioner itself, and does not include the concurrent use of other devices.

If the electrical power is inadequate, contact your electric power company.

Install a breaker in a location that is not exposed to high temperatures. If the temperature surrounding the breaker is too high, the amperage at which the breaker cuts out may decrease.

When using an earth leakage breaker that has been designed solely for ground fault protection, be sure to install a fuse-equipped switch or circuit breaker.

⚠ CAUTION

This system uses an inverter, which means that it must be used an earth leakage breaker that can handle harmonics in order to prevent malfunctioning of the earth leakage breaker itself.

Do not use crossover power supply wiring for the outdoor unit.

If the temperature surrounding the breaker is too high, the amperage at which the breaker cuts out may decrease.

When the electrical switchboard is installed outdoors, place it under lock and key so that it is not easily accessible.

Start wiring work after closing branch switch and over current breaker.

Transmission cable between indoor unit and outdoor unit is 230 V.

Be sure not to remove thermistor sensor etc. from power wiring and connection wiring. Compressor may fail if operated while removed.

Always keep to the maximum length of the connection cable. Exceeding the maximum length may lead to erroneous operation.

Do not start operation until the refrigerant is charged completely. The compressor will fail if it is operated before the refrigerant piping charging is complete.

The static electricity that is charged to the human body can damage the control PC Board when handling the control PC Board for address setting, etc.

Please keep caution to the following points.

Provide the grounding of Indoor unit, Outdoor unit and Option equipment.

Cut off the power supply (breaker).

Touch the metal section (such as the unpainted control box section) of the indoor or outdoor unit for more than 10 seconds. Discharge the static electricity in your body.

Never touch the component terminal or pattern on the PC Board.

Be careful not to generate a spark as follows for using a flammable refrigerant.

- Do not remove the fuse while power is on.
- Do not disconnect plug from the wall outlet and the wiring while the power is on.
- It is recommended to position the outlet connection in a high position. Place the cords so that they do not get tangled.

How to connect wiring to the terminal

Caution when wiring cable

- When stripping off the coating of a lead wire, always use a special tool such as a wire stripper. If there is no special tool available, carefully strip the coating with a knife etc.

- (1) Use ring terminals with insulating sleeves as shown in the figure below to connect to the terminal block.
- (2) Securely clamp the ring terminals to the wires using an appropriate tool so that the wires do not come loose.

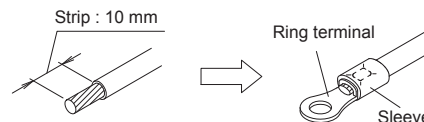

- (3) Use the specified wires, connect them securely, and fasten them so that there is no stress placed on the terminals.
- (4) Use an appropriate screwdriver to tighten the terminal screws. Do not use a screwdriver that is too small, otherwise, the screw heads may be damaged and prevent the screws from being properly tightened.
- (5) Do not tighten the terminal screws too much, otherwise, the screws may break.

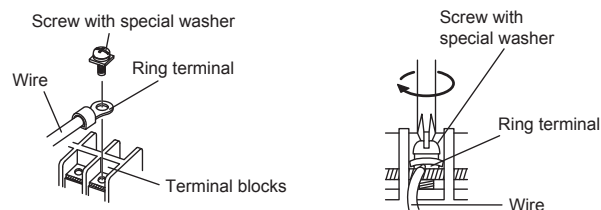

- (6) See the table below for the terminal screw tightening torques.

Tightening torque [N·m (kgf·cm)]	
M4 screw	1.2 to 1.8 (12 to 18)
M5 screw	2.0 to 3.0 (20 to 30)

5.3. Wiring method

5.3.1. Connection diagrams

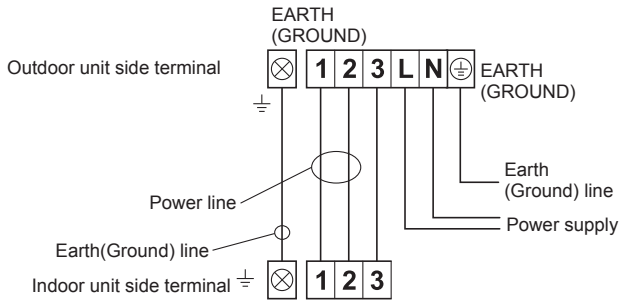

5.3.2. Cable preparation

- Keep the earth (ground) wire longer than the other wires.

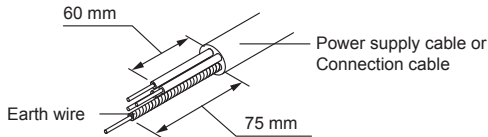

5.3.3. Wiring procedure

- Remove the outdoor unit switch cover. (See "5.1. Switch cover removal".)
- Remove the outdoor unit cable clamp.
- Connect the power supply cable and the connection cable to terminal.
- Fasten the power supply cable and connection cable with cable clamp.
- Install the switch cover. (See "5.1. Switch cover removal".)

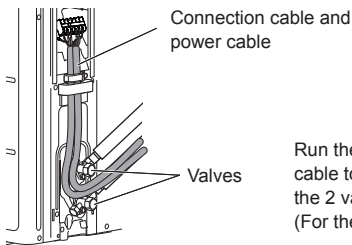
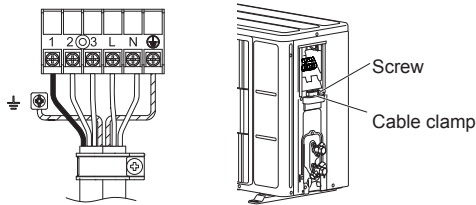

Run the connection cable and power supply cable to the rear of the outdoor unit between the 2 valves as shown in the figure. (For the switch cover to be easily installed.)

5.4. Pipe connection

CAUTION

Do not use mineral oil on a flared part. Prevent mineral oil from getting into the system as this would reduce the lifetime of the units.

While welding the pipes, be sure to blow dry nitrogen gas through them.

Flaring

- Cut the connection pipe to the necessary length with a pipe cutter.
- Hold the pipe downward so that cuttings will not enter the pipe and remove the burrs.
- Insert the flare nut onto the pipe and flare the pipe with a flaring tool. Insert the flare nut (always use the flare nut attached to the indoor and outdoor units respectively) onto the pipe and perform the flare processing with a flare tool. Use the special R410A flare tool, or the conventional (for R22) flare tool.

When using the conventional flare tool, always use an allowance adjustment gauge and secure the A dimension shown in the following table.

Check if [L] is flared uniformly and is not cracked or scratched.

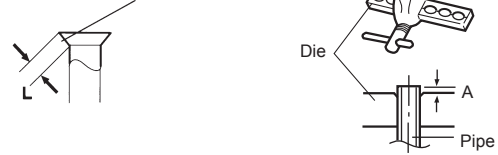

Pipe outside diameter	A (mm)		
	Flaring tool for R410A, clutch type	Conventional (R22) Flaring tool	
		Clutch type	Wing nut type
ø 6.35 mm (1/4")	0 to 0.5	1.0 to 1.5	1.5 to 2.0
ø 9.52 mm (3/8")			
ø 12.70 mm (1/2")			
ø 15.88 mm (5/8")			
ø 19.05 mm (3/4")			

Bending pipes

- When bending the pipe, be careful not to crush it.
- To prevent breaking of the pipe, avoid sharp bends. Bend the pipe with a radius of curvature of 70 mm or more.
- If the copper pipe is bent the pipe or pulled to often, it will become stiff. Do not bend the pipes more than three times at one place.

Flare connection

- Detach the caps and plugs from the pipes.

CAUTION

Be sure to apply the pipe against the port on the indoor unit and the outdoor unit correctly. If the centering is improper, the flare nut cannot be tightened smoothly. If the flare nut is forced to turn, the threads will be damaged.

Do not remove the flare nut from the indoor unit pipe until immediately before connecting the connection pipe.

- Centering the pipe against port on the outdoor unit, turn the flare nut with your hand.



- Tighten the flare nut of the connection pipe at the outdoor unit valve connector.

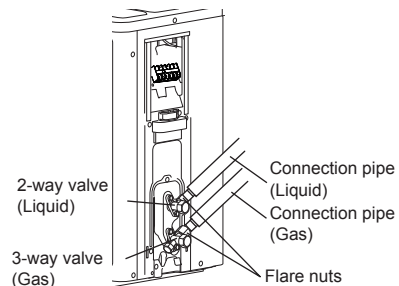

- (4) When the flare nut is tightened properly by your hand, use a torque wrench to finally tighten it.

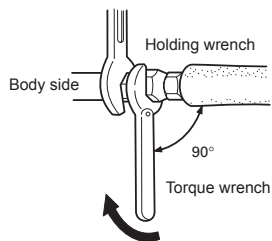

CAUTION

Hold the torque wrench at its grip, keeping it in the right angle with the pipe, in order to tighten the flare nut correctly.

Flare nut [mm (in.)]	Tightening torque [N·m (kgf·cm)]
6.35 (1/4) dia.	16 to 18 (160 to 180)
9.52 (3/8) dia.	32 to 42 (320 to 420)
12.70 (1/2) dia.	49 to 61 (490 to 610)
15.88 (5/8) dia.	63 to 75 (630 to 750)
19.05 (3/4) dia.	90 to 110 (900 to 1100)

CAUTION

Fasten a flare nut with a torque wrench as instructed in this manual. If fastened too tight, the flare nut may be broken after a long period of time and cause a leakage of refrigerant.

During installation, make sure that the refrigerant pipe is attached firmly before you run the compressor. Do not operate the compressor under the condition of refrigerant piping not attached properly with 3-way valves open. This may cause abnormal pressure in the refrigeration cycle that leads to breakage and even injury.

5.5. Sealing test

WARNING

Before operating the compressor, install the pipes and securely connect them. Otherwise, if the pipes are not installed and if the valves are open when the compressor operates, air could enter the refrigeration cycle. If this happens, the pressure in the refrigeration cycle will become abnormally high and cause damage or injury.

After the installation, make sure there is no refrigerant leakage. If the refrigerant leaks into the room and becomes exposed to a source of fire such as a fan heater, stove, or burner, it produces a toxic gas.

Do not subject the pipes to strong shocks during the sealing test. It can rupture the pipes and cause serious injury.

CAUTION

Do not block the walls and the ceiling until the sealing test and the charging of the refrigerant gas have been completed.

For maintenance purposes, do not bury the piping of the outdoor unit.

- After connecting the pipes, perform a sealing test.
- Make sure that the 3-way valves are closed before performing a sealing test.
- Pressurize nitrogen gas to 4.15 MPa to perform the sealing test.
- Add nitrogen gas to both the liquid pipes and the gas pipes.
- Check all flare connections and welds. Then, check that the pressure has not decreased.
- Compare the pressures after pressurizing and letting it stand for 24 hours, and check that the pressure has not decreased.
 - * When the outdoor air temperature changes 5 °C, the test pressure changes 0.05 MPa. If the pressure has dropped, the pipe joints may be leaking.
- If a leak is found, immediately repair it and perform the sealing test again.
- After completing the sealing test, release the nitrogen gas from both valves.
- Release the nitrogen gas slowly.

5.6. Vacuum process

CAUTION

Perform a refrigerant leakage test (air tightness test) to check for leaks using nitrogen gas while all valves in the outdoor unit are closed. (Use the test pressure indicated on the nameplate.)

Be sure to evacuate the refrigerant system using a vacuum pump.

The refrigerant pressure may sometimes not rise when a closed valve is opened after the system is evacuated using a vacuum pump. This is caused by the closure of the refrigerant system of the outdoor unit by the electronic expansion valve. This will not affect the operation of the unit.

If the system is not evacuated sufficiently, its performance will drop.

Use a clean gauge manifold and charging hose that were designed specifically for use with R410A. Using the same vacuum equipment for different refrigerants may damage the vacuum pump or the unit.

Do not purge the air with refrigerants, but use a vacuum pump to evacuate the system.

Refrigerant for purging the air is not charged in the outdoor unit at the factory.

- (1) Remove the cap, and connect the gauge manifold and the vacuum pump to the charging valve by the service hoses.
- (2) Vacuum the indoor unit and the connecting pipes until the pressure gauge indicates -0.1 MPa (-76 cmHg).
- (3) When -0.1 MPa (-76 cmHg) is reached, operate the vacuum pump for at least 60 minutes.
- (4) Disconnect the service hoses and fit the cap to the charging valve to the specified torque.
- (5) Remove the blank caps, and fully open the spindles of the 3-way valves with a hexagon wrench [Torque: 6~7 N·m (60 to 70 kgf·cm)].
- (6) Tighten the blank caps of the 3-way valves to the specified torque.

	Tightening torque	
Blank cap	6.35 mm (1/4 in.)	20 to 25 N·m (200 to 250 kgf·cm)
	9.52 mm (3/8 in.)	20 to 25 N·m (200 to 250 kgf·cm)
	12.70 mm (1/2 in.)	28 to 32 N·m (280 to 320 kgf·cm)
	15.88 mm (5/8 in.)	30 to 35 N·m (300 to 350 kgf·cm)
	19.05 mm (3/8 in.)	35 to 40 N·m (350 to 400 kgf·cm)
Charging port cap	12.5 to 16 N·m (125 to 160 kgf·cm)	

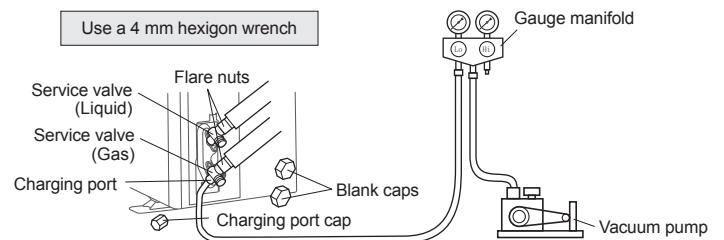

5.7. Installing insulation

- Determine the thickness of the insulation material by referring to Table A.

Table A, Selection of insulation

(Use an insulation material with equal heat transmission rate or below 0.040 W/(m·k))

Relative humidity		Recommended minimum thickness for heat insulating material (mm)			
		≤ 70%	≤ 75%	≤ 80%	≤ 85%
Pipe diameter [mm (in.)]	6.35 (1/4")	8	10	13	17
	9.52 (3/8")	9	11	14	18
	12.70 (1/2")	10	12	15	19
	15.88 (5/8")	10	12	16	20
	19.05 (3/4")	10	13	16	21

- When an ambient temperature and relative humidity exceed 32 °C (DB) and 85% respectively, please strengthen heat insulation for the refrigerant pipes.

6. TEST RUN

Make a TEST RUN in accordance with the installation manual for the indoor unit.