

# SIEMENS



**POS8.4420/109; POS8.4440/109**

**Room operator units**

**Basic Documentation**

# Table of Contents

<b>1</b>	<b>About this document</b>	<b>3</b>
1.1	Revision history	3
1.2	Before you start	3
1.3	Reference documents	4
<b>2</b>	<b>Product overview</b>	<b>5</b>
2.1	Type summary	5
2.1.1	Equipment combinations	5
2.2	Features	5
2.3	System topology	5
2.4	Mechanical design	6
2.5	Diagrams	6
2.5.1	Connection terminals	6
2.5.2	Connection diagrams	7
2.6	Dimensions	8
<b>3</b>	<b>Important information on safety and disposal</b>	<b>9</b>
3.1	General regulations	9
3.2	Device-specific regulations	9
3.3	Notes on EMC optimization	9
3.4	Disposal	10
<b>4</b>	<b>Mounting and installation</b>	<b>11</b>
4.1	Preparation	11
4.2	Mounting instructions	12
<b>5</b>	<b>Engineering</b>	<b>14</b>
<b>6</b>	<b>Commissioning</b>	<b>36</b>
6.1	Programming pin and service LED	36
6.1.1	Addressing	36
6.1.2	Connection test	36
6.1.3	Reset to factory setting	37
<b>7</b>	<b>Technical data</b>	<b>38</b>
<b>8</b>	<b>Functions</b>	<b>40</b>
<b>9</b>	<b>Operation</b>	<b>42</b>
9.1	Ventilation page	42
9.2	Temperature page	43
9.3	Domestic hot water page	44
9.4	Notification page	44
9.5	Clock page	48
9.6	Scheduler settings	48
9.7	Standard and expert settings	49
9.8	Standby page	51
<b>10</b>	<b>Appendix</b>	<b>52</b>
10.1	Parameters	52
10.2	Object list	52

# 1 About this document

## 1.1 Revision history

Revision	Date	Changes	Section
e	Sep 2021	Added info for blinking screen	Chapter 5 and Chapter 9
d	May 2021	Added info for POS8.4440/109 about humidity	Chapter 7
c	October 2020	Canceled POS3.3515/100	Chapter 2.1.1
b	August, 2019	Added chapter "Engineering" and "Object list"	Chapter 5 and Chapter 10
a	November, 2018	First edition	All

## 1.2 Before you start

### Trademarks

The table below lists the third-party trademarks used in this document and their legal owners. The use of trademarks is subject to international and domestic provisions of the law.

Trademarks	Legal owner
KNX®	KNX Association, B - 1831 Brussels-Diegem Belgium <a href="http://www.knx.org/">http://www.knx.org/</a>

All product names listed in the table are registered (®) or not registered (™) trademarks of the owner listed in the table. We forgo the labeling (e.g. using the symbols ® and ™) of trademarks for the purposes of legibility based on the reference in this section.

### Copyright

This document may be duplicated and distributed only with the express permission of Siemens, and may be passed on only to authorized persons or companies with the required technical knowledge.

### Quality assurance

These documents were prepared with great care.

- The contents of all documents are checked at regular intervals.
- All necessary corrections are included in subsequent versions.
- Documents are automatically amended as a consequence of modifications and corrections to the products described.

Please make sure that you are aware of the latest document revision date.

If you find any lack of clarity while using this document, or if you have any criticisms or suggestions, please contact the nearest branch office. Addresses for Siemens regional companies are available at [www.siemens.com/sbt](http://www.siemens.com/sbt).

### Document use/ request to the reader

Before using our products, it is important that you read the documents supplied with or ordered at the same time as the products (equipment, applications, tools etc.) carefully and in full.

We assume that persons using our products and documents are authorized and properly trained and have the requisite technical knowledge to use our products as intended.

Additional information on products and applications is available:

- On the intranet (for Siemens employees only) at <https://workspace.sbt.siemens.com/content/00001123/default.aspx>
- At your next Siemens branch office [www.siemens.com/sbt](http://www.siemens.com/sbt) or at your system suppliers.
- From the support team in the headquarters [fieldsupport-zug.ch.sbt@siemens.com](mailto:fieldsupport-zug.ch.sbt@siemens.com) if no local contact is available.

Siemens assumes no liability to the extent allowed under the law for any losses resulting from a failure to comply with the aforementioned points or for the improper compliance of the same.

### 1.3 Reference documents

Ref.	Document title	Document number
[1]	Data sheet	A6V11519429
[2]	Mounting instructions	A6V10733764

## 2 Product overview

### 2.1 Type summary

Product number	Stock number	Feature		LCD display with backlight	Minimal order size
		Temperature sensor	Humidity sensor		
POS8.4420/109	S55625-H422-A100	Yes	No	Yes	20
POS8.4440/109	S55625-H444-A100	Yes	Yes	Yes	20

#### 2.1.1 Equipment combinations

Type	Type no.	Document ID	Description
Controller	POS3.5715/100	A6V11417931	For HVAC controlling, switching and monitoring functions

### 2.2 Features

- Measurement of room temperature (POS8.4420/109)
- Measurement of room temperature and humidity (POS8.4440/109)
- Keys to adjust the room temperature setpoint, ventilation, domestic hot water, scheduler settings depending on the controller application
- LCD display of room temperature, operating modes, humidity (only for POS8.4440/109), scheduler, notification, and clock setting
- Operation with 8 pushbuttons
- 2-wire interface to the controller through KNX PL-Link
- Power supply of the room operator unit over KNX PL-Link
- LCD display with backlight

### 2.3 System topology

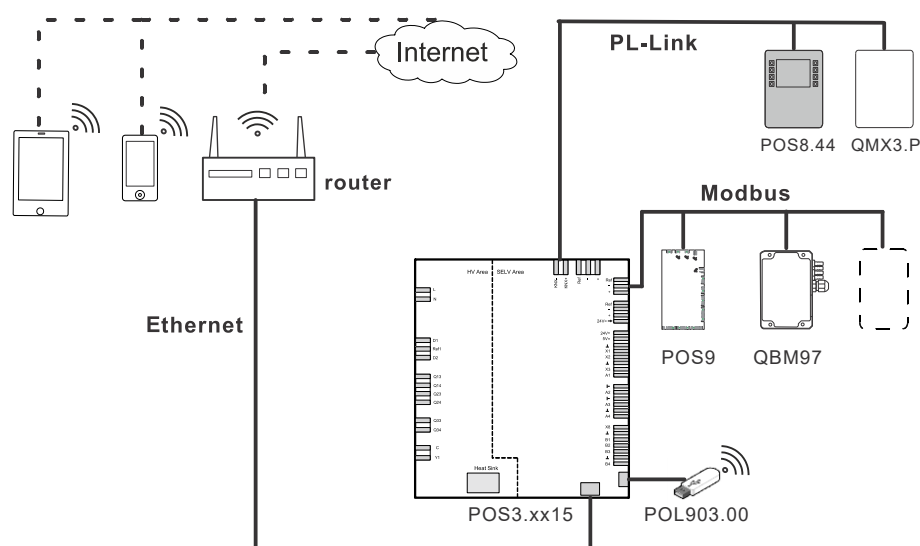

A6V114171220Z01

## 2.4 Mechanical design

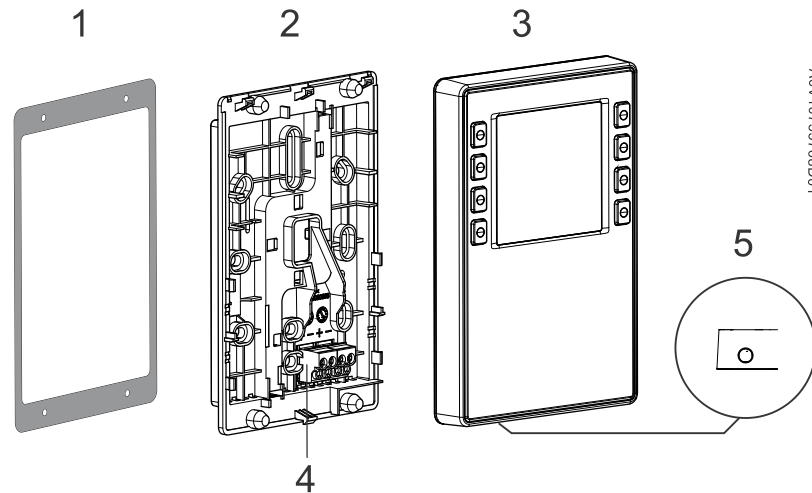

1	Gasket for panel mounting	4	KNX PL-Link bus connector
2	Base plate with <ul style="list-style-type: none"> <li>• screw holes for all common conduit boxes</li> <li>• guide channels for wiring from center, up, or bottom</li> </ul>	5	Jack connector for tool connection
3	Room operator unit		

## 2.5 Diagrams

### 2.5.1 Connection terminals

#### KNX PL-Link plug

Connector	Pin	Description
	+	KNX PL-Link (positive)
	-	KNX PL-Link (negative)

To find the location of the KNX PL-Link plug, refer to Mechanical design

**NOTICE! Users can choose either pair of the pins to connect.**



#### **NOTICE**

##### **Wires are NOT interchangeable!**

The device is protected against faulty wiring, but communications does not work on interchanged wires. The KNX / KNX PL-Link bus **MUST NOT** be connected to the tool plug, only the tool.

## Tool plug

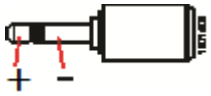
Connector	Pin	Description
	+	KNX PL-Link (positive)
	-	KNX PL-Link (negative)

## 2.5.2 Connection diagrams

### Operation

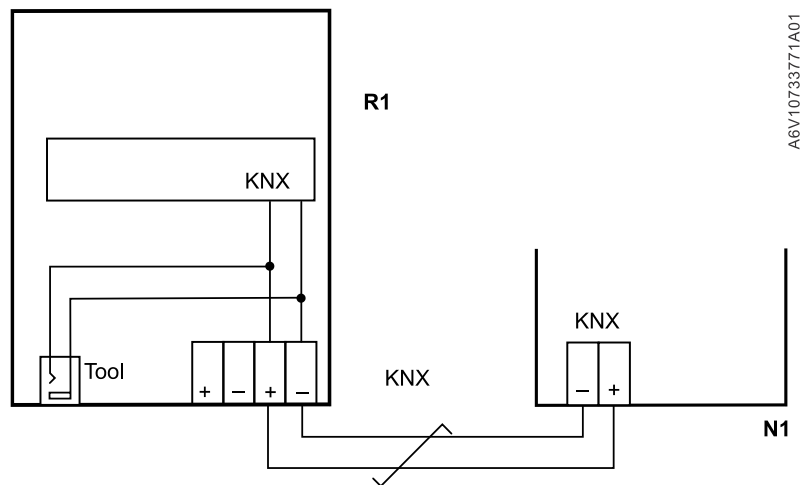

- R1 The device - room operating unit (POS8.44xx)
- N1 The controller - room automation station
-  Twisted pair

## 2.6 Dimensions

Unit: mm

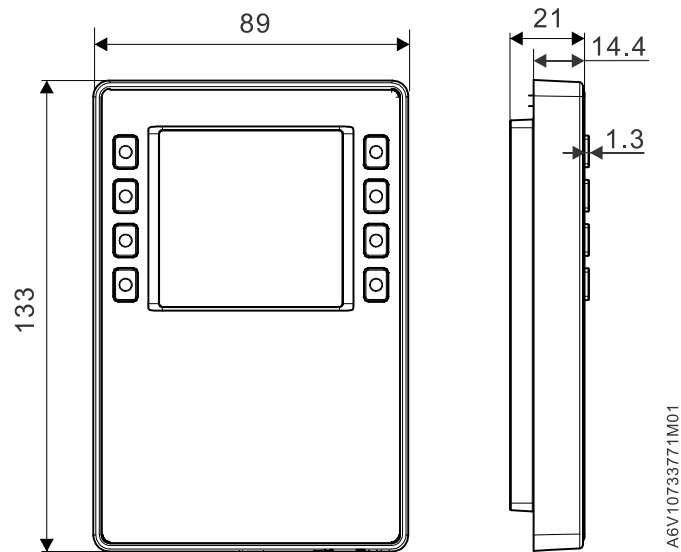

Fig. 1: Dimensions for housing

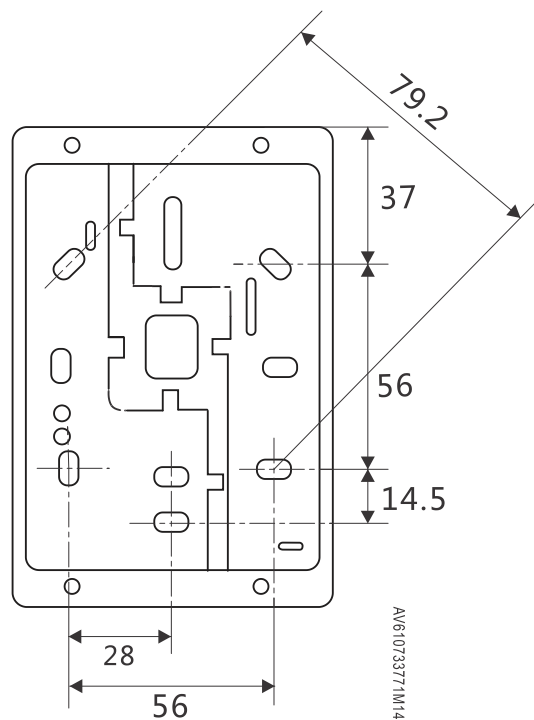

Fig. 2: Dimensions for mounting



## 3 Important information on safety and disposal

This section explains general and system-specific regulations for mains and operating voltages. It includes important information for your safety and the safety of the entire plant.

### 3.1 General regulations

Comply with the following general regulations during engineering and execution:

- Electrical and mains power regulations for the given country.
- Other applicable, national regulations.
- Building installation regulations for the given country.
- Regulations of the utility company.
- Diagrams, cable lists, dispositions, specifications, and orders by the customer or authorized engineering office.
- Third-party regulations, for example, by the general contractor or building owner.

The electrical safety for building automation and control systems by Siemens is essentially based on **safely separating low voltage from mains voltage**.

### 3.2 Device-specific regulations

#### KNX bus supply

Note permissible line lengths and topologies when planning and installing controllers and field devices featuring KNX bus connection. Make sure the bus supply complies with the KNX standard.

#### Maintenance

The device is maintenance free. Only the manufacturer can maintain the device.

### 3.3 Notes on EMC optimization

#### Cable ducts

When setting up cable ducts, separate strongly interfering cables from susceptible entities.

#### Cable types

- Interfering cables: Motor cables especially from motors supplied by inverters, energy-supplying cables.
- Susceptible entities: Control cables, low voltage cables, interface cables, LAN cables, digital and analog signal cables.

#### Separate cables

- Both types of cables can be in the same cable duct, but in separate compartments.
- If no three-sided, closed duct with separating wall is available, the interfering cables must be separated by at least 150 mm from the others or placed in separate ducts.
- Crossings of strongly interfering cables with possibly susceptible entities must be at a right angle.
- In rare cases, signal and interfering power cables may be run in parallel, resulting in a high interference risk.

#### Unscreened cables

It is recommended to use unscreened cables. Comply with the manufacturer's installation recommendations for selecting unscreened cables. In general, **unshielded twisted pair cables** have sufficient EMC properties for technical building applications (including data applications) and do not require coupling to surrounding earth.

## 3.4 Disposal

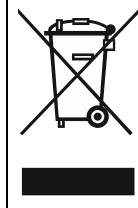

The device is considered an electronic device for disposal in accordance with European Directive and may not be disposed of as domestic waste.

- Use only designated channels for disposing the devices.
- Comply with all local and currently applicable laws and regulations.

## 4 Mounting and installation

Comply with the following notes as well as the *Mounting instructions* (A6V10733764) to mount the room operation unit.

### 4.1 Preparation

**Check package contents** Check the package contents for visible signs of transport damage and for completeness.

Do not install parts damaged during shipment. Contact your Siemens representative in the event of damaged parts.

**Check operating conditions** Note the information in the data sheet of these operating instructions before installing the device:

- Climatic ambient conditions
- Protection classes

**Check locations**

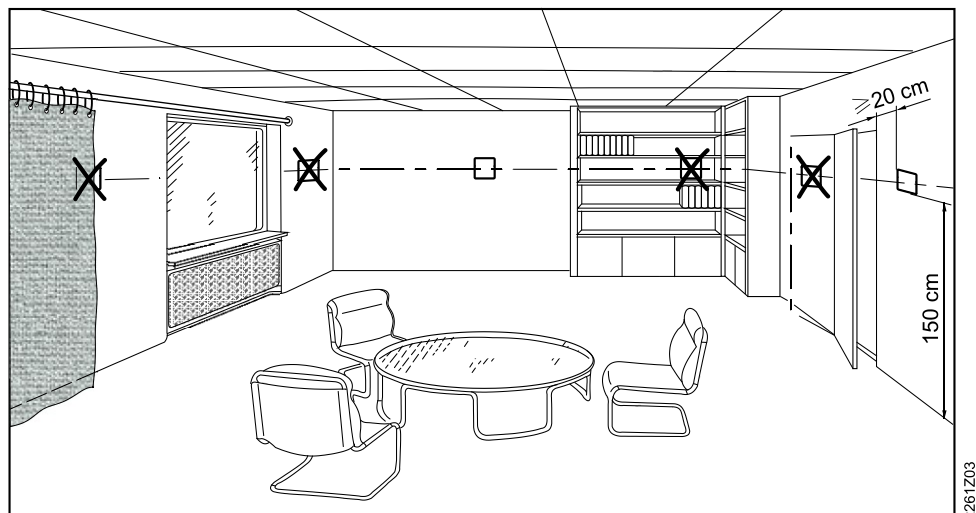

- The devices are suitable for wall mounting and panel mounting.
- Recommended height: 1.50 m above the floor.
- Do not mount the devices in recesses, shelves, behind curtains or doors, or above or near heat sources.
- Avoid direct solar radiation and drafts.
- Seal the conduit box or the installation tube if any, as air currents can affect sensor readings.
- Adhere to allowed ambient conditions.

## 4.2 Mounting instructions

### Mounting instructions

- *Mounting instructions A6V10733764* are enclosed with the devices.

### Wall mounting

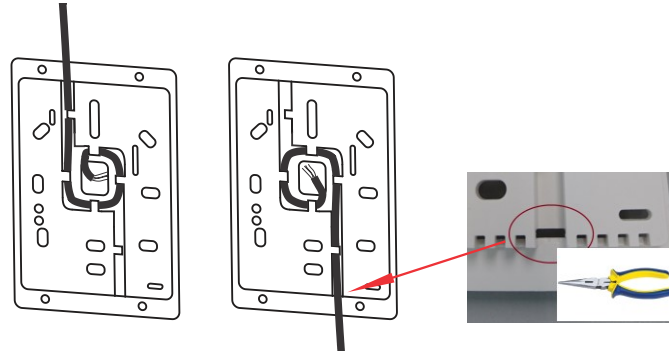

A6V10733771M02

- Remove the breakout on the housing before putting the cable into the gaining channel.
- If 4-wire cables are used for daisy chain wiring, remove the cable coating, as it will not fit in the gaining channel.

### Cable ducts on the wall

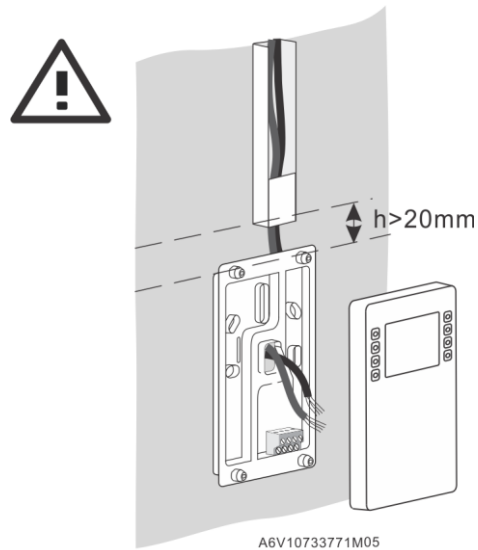

A6V10733771M05

- Keep a distance of at least 20 mm from the base plate to any object above the base plate such as cable ducts to snap the device cover onto the base plate.

### Panel mounting

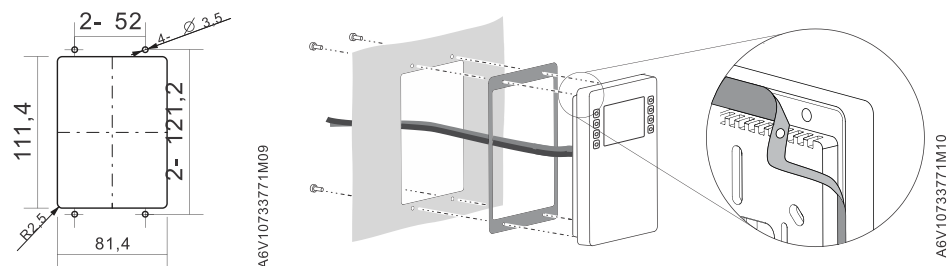

A6V10733771M09

A6V10733771M10

Dismounting/service

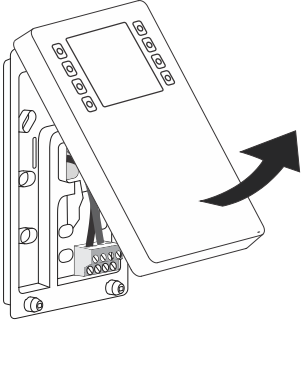
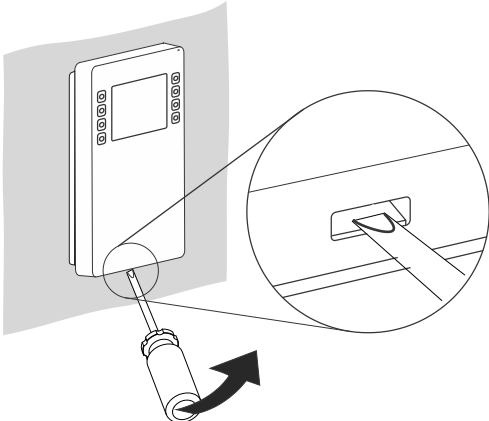

## 5 Engineering

TempOutsideEff

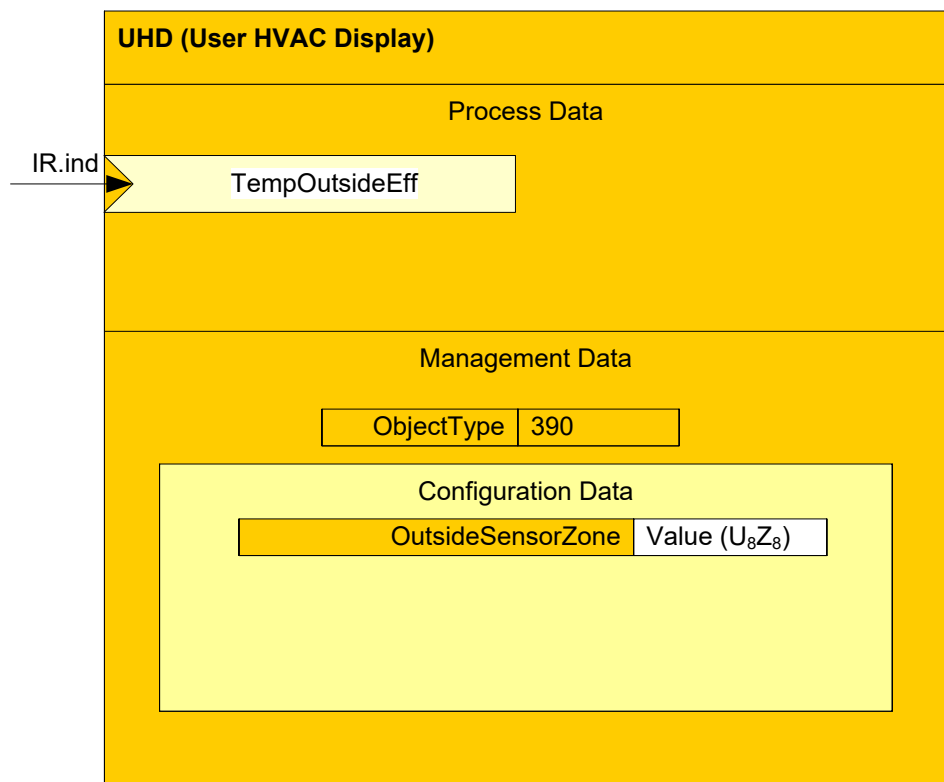
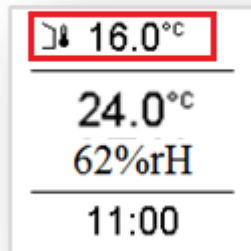

TempRoomEff

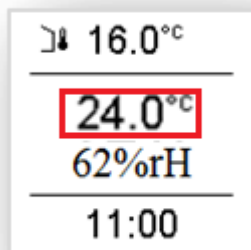

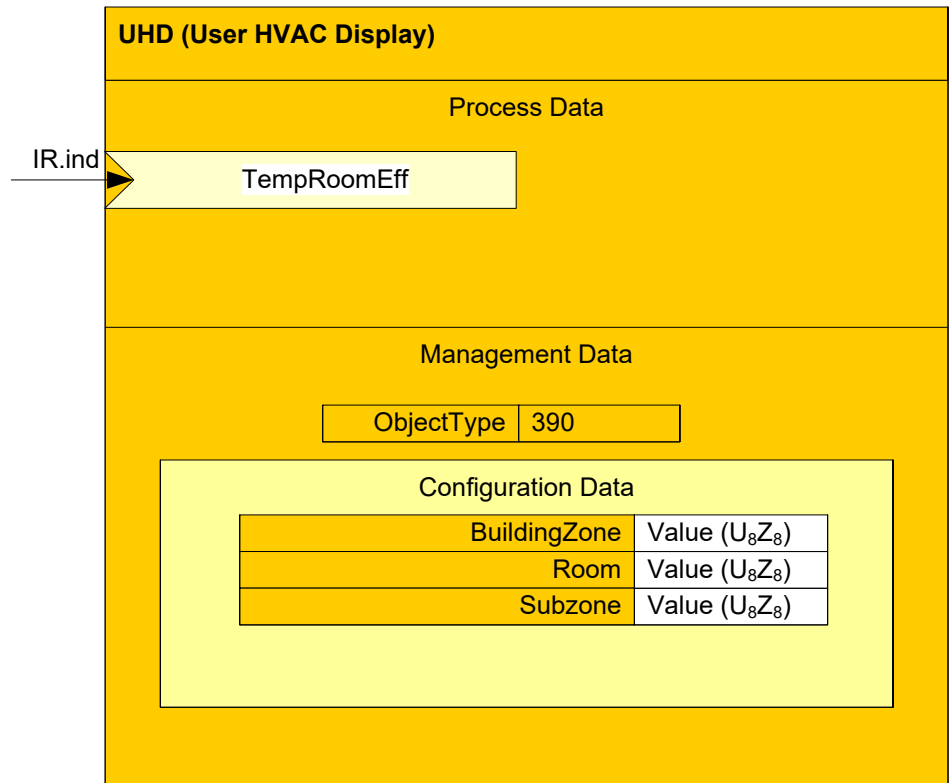

**HumRelRoomEff**

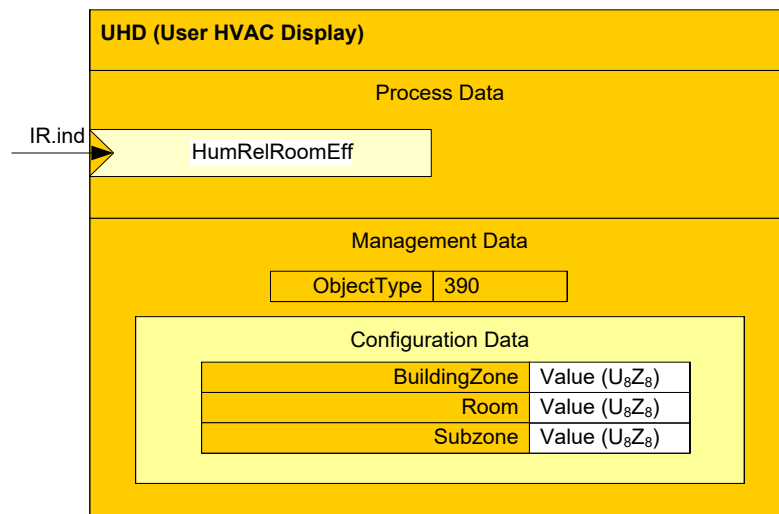

Parameters required to realize the full function:

Property name	Property identifier	Property access	LTE service	Description	KNX Datapoint Type (DPT)
Interface Object Type	1	R	---	390 = UHD	DPT_PropData Type (DPT_ID = 7.010)
TempOutsideEff	OTS.155	----	IR.ind	Process Data Input	DPT_TempHV ACAbs_Z
local copy *)	155	R	---	Diagnostic Value	
TempRoomEff	RTS.155	----	IR.ind	Process Data Input	DPT_TempHV ACAbs_Z
local copy *)	157	R	---	Diagnostic Value	
HumRelRoomEff	RRHS.155	----	IR.ind	Process Data Input	DPT_RelValue_Z
local copy *)	172	R	---	Diagnostic Value	
BuildingZone	101	R/W	---	Configuration Data	DPT_UCountValue8_Z
Room	102	R/W	---	Configuration Data	DPT_UCountValue8_Z
Subzone	103	R/W	---	Configuration Data	DPT_UCountValue8_Z
OutsideSensor Zone	104	R/W	---	Configuration Data	DPT_UCountValue8_Z

### Setting of HVAC Mode

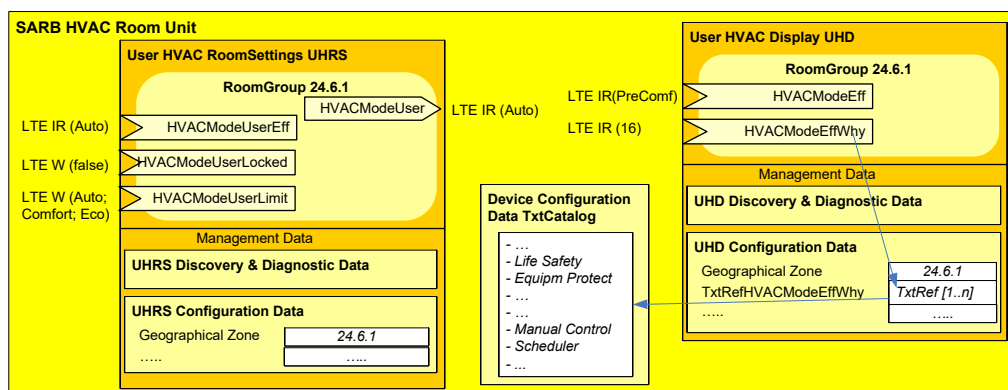

Parameters required to realize the full function:



Property name	Property identifier	Property access	LTE service	Description	KNX Datapoint Type (DPT)
Interface Object Type	1	R	---	384 = UHRS	DPT_PropData Type (DPT_ID = 7.010)
HVACModeUser	55	R	IR.req	Process Data Output	DPT_HVACMode_Z
HVACModeUserLocked	156	R/W	W.ind	Process Data Input	DPT_Bool
HVACModeUserEff	RSMHD.57	----	IR.ind	Process Data Input	DPT_HVACMode_Z
local copy *)	157	R	---	Diagnostic Value	
BuildingZone	101	R/W	---	Configuration Data	DPT_UCountValue8_Z
Room	102	R/W	---	Configuration Data	DPT_UCountValue8_Z
Subzone	103	R/W	---	Configuration Data	DPT_UCountValue8_Z

Property name	Property identifier	Property access	LTE service	Description	KNX Datapoint Type (DPT)
Interface Object Type	1	R	---	390 = UHD	DPT_PropData Type (DPT_ID = 7.010)
HVACModeEff	RSMHD.51	----	IR.ind	Process Data Input	DPT_HVACMode_Z
local copy *)	163	R	---	Diagnostic Value	
BuildingZone	101	R/W	---	Configuration Data	DPT_UCountValue8_Z
Room	102	R/W	---	Configuration Data	DPT_UCountValue8_Z
Subzone	103	R/W	---	Configuration Data	DPT_UCountValue8_Z

### Unoccupied mode



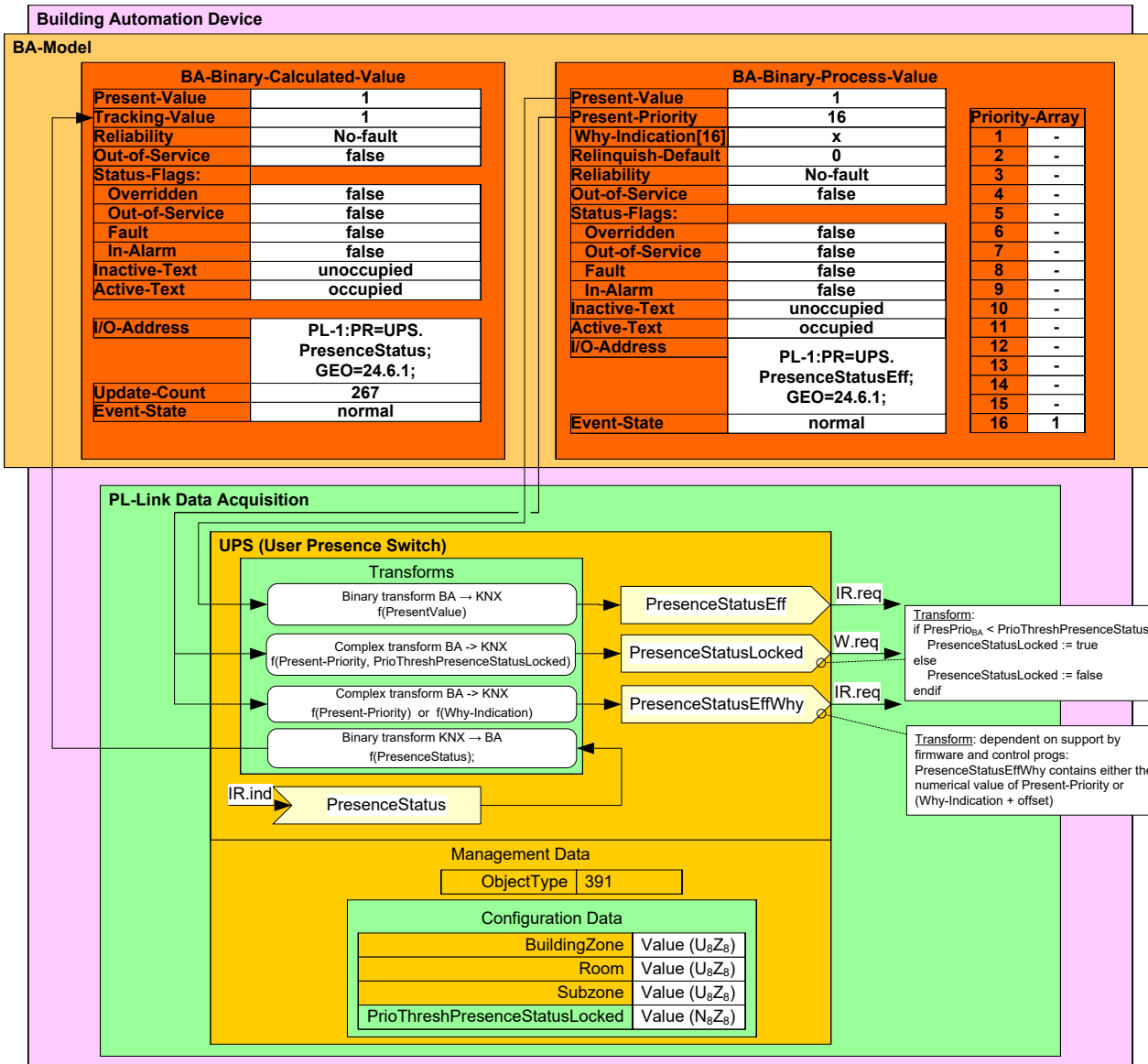

Parameters required to realize the full function:

Property name	Property identifier	Property access	LTE service	Description	KNX Datapoint Type (DPT)
Interface Object Type	1	R	---	391 = UPS	DPT_PropData Type
(DPT_ID = 7.010)					
PresenceStatus	51	R/W	IR.req	Process Data Output	DPT_Occupancy
PresenceStatusLocked	155	R/W	W.ind	Process Data Input	DPT_Bool
PresenceStatusEff	UPS.156	----	IR.ind	Process Data Input	DPT_Occupancy
local copy *)	201	R	---	Diagnostic Value	
BuildingZone	101	R/W	---	Configuration Data	DPT_UCountValue8_Z
Room	102	R/W	---	Configuration Data	DPT_UCountValue8_Z

Temporary mode

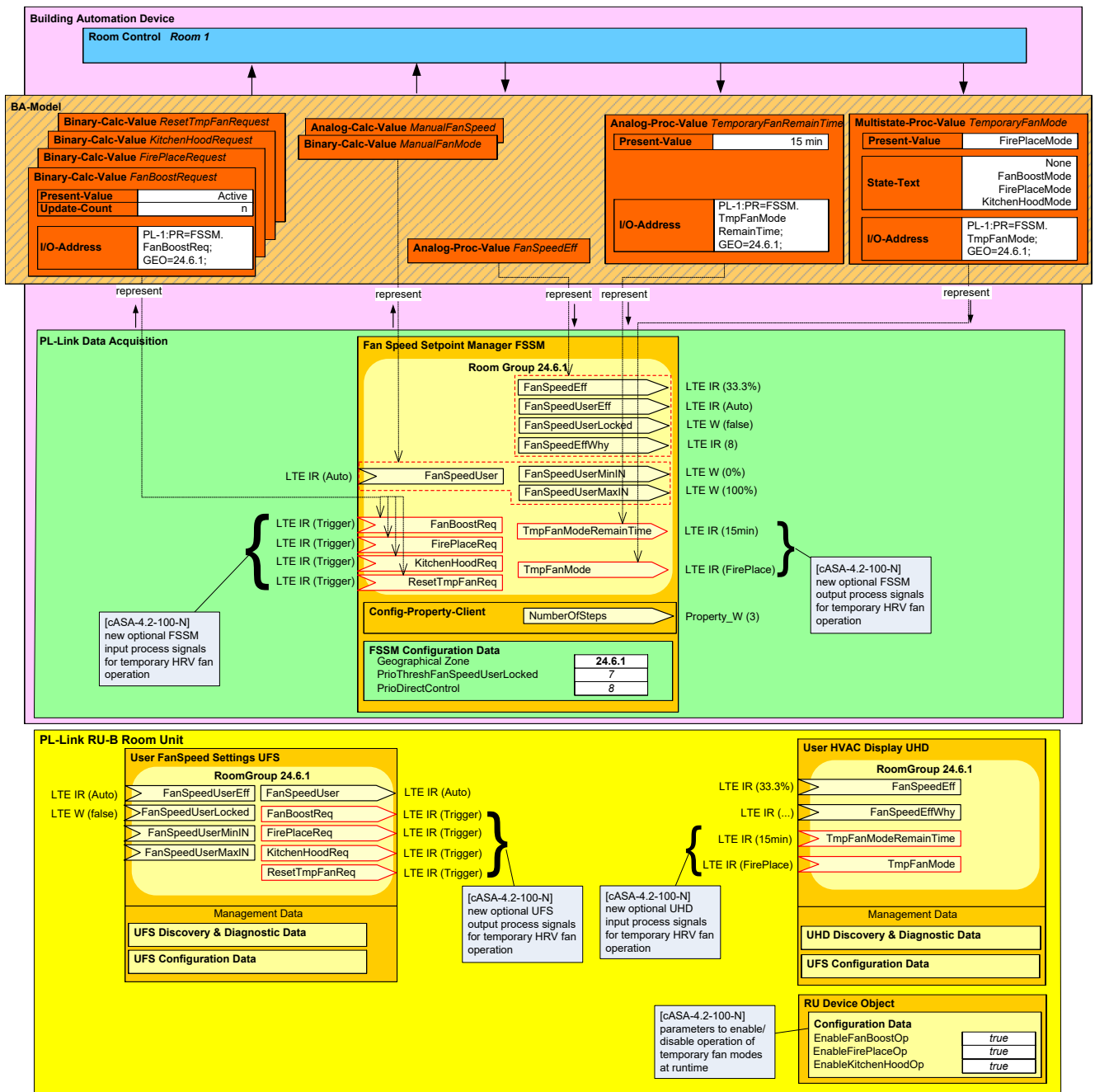

Parameters required to realize the full function:

Property name	Property identifier	Property access	LTE service	Description	KNX Datapoint Type (DPT)
Interface Object Type	1	R	---	390 = UHD	DPT_PropDataType (DPT_ID = 7.010)
TmpFanMode	FSSM.166	----	IR.ind	Process Data Input	DPT_TmpFanMode
local copy *)	208	R	---	Diagnostic Value	
TmpFanModeRemainTime	FSSM.167	----	IR.ind	Process Data Input	DPT_TimePeriodMin
local copy *)	209	R	---	Diagnostic Value	
BuildingZone	101	R/W	---	Configuration Data	DPT_UCountValue8_Z
Room	102	R/W	---	Configuration Data	DPT_UCountValue8_Z
Subzone	103	R/W	---	Configuration Data	DPT_UCountValue8_Z

Property name	Property identifier	Property access	LTE service	Description	KNX Datapoint Type (DPT)
Interface Object Type	1	R	---	393 = UFS	DPT_PropDataType (DPT_ID = 7.010)
FanBoostReq	162	R	IR.req	Process Data Output	DPT_Trigger
FirePlaceReq	163	R	IR.req	Process Data Output	DPT_Trigger
KitchenHoodReq	164	R	IR.req	Process Data Output	DPT_Trigger
ResetTmpFanReq	165	R	IR.req	Process Data Output	DPT_Trigger
FanBoostProgrammingTime	166	R	IR.req	Process Data Output	DPT_TimePeriodMin
FirePlaceProgrammingTime	167	R	IR.req	Process Data Output	DPT_TimePeriodMin
BuildingZone	101	R/W	---	Configuration Data	DPT_UCountValue8_Z
Room	102	R/W	---	Configuration Data	DPT_UCountValue8_Z
Subzone	103	R/W	---	Configuration Data	DPT_UCountValue8_Z

### Temperature setpoint

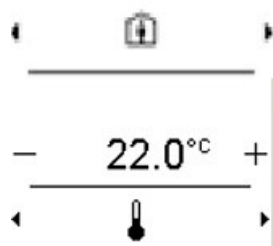

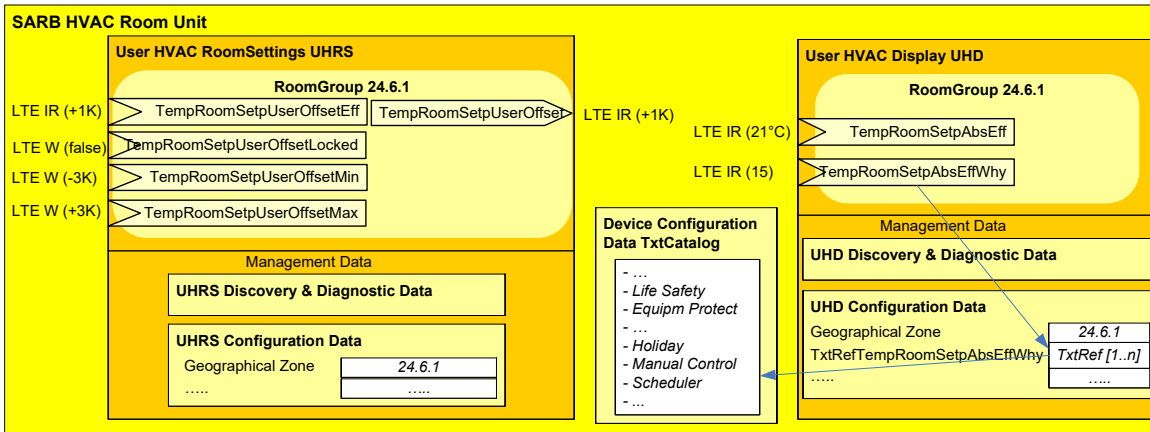

Monitoring of outside temperature

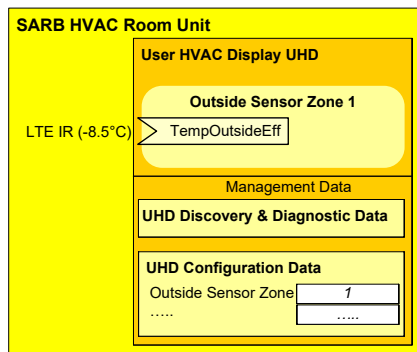

Monitoring of room temperature

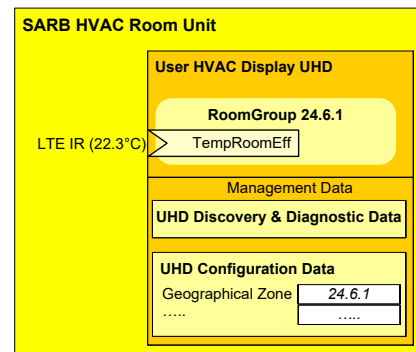

Parameters required to realize the full function:

Property name	Property identifier	Property access	LTE service	Description	KNX Datapoint Type (DPT)
Interface Object Type	1	R	---	384 = UHRS	DPT_PropData Type (DPT_ID = 7.010)
TempRoomSetpUserOffset	52	R	IR.req	Process Data Output	DPT_TempHV ACRel_Z
TempRoomSetpUserOffsetMinIN	158	R/W	W.ind	Process Data Input, Configuration Data	DPT_TempHV ACRel_Z
TempRoomSetpUserOffsetMaxIN	159	R/W	W.ind	Process Data Input, Configuration Data	DPT_TempHV ACRel_Z

Property name	Property identifier	Property access	LTE service	Description	KNX Datapoint Type (DPT)
TempRoomSetpUserOffsetLocked	160	R/W	W.ind	Process Data Input	DPT_BooL
TempRoomSetpUserOffsetEff	RSMHD.58	----	IR.ind	Process Data Input	DPT_TempHV ACRel_Z
local copy *)	161	R	---	Diagnostic Value	

Property name	Property identifier	Property access	LTE service	Description	KNX Datapoint Type (DPT)
StepIncrement HMI_TRSetpUsOffset	171	R/W	---	Configuration Data	DPT_Value_1_ Ucount
BuildingZone	101	R/W	---	Configuration Data	DPT_UCountV alue8_Z
Room	102	R/W	---	Configuration Data	DPT_UCountV alue8_Z
Subzone	103	R/W	---	Configuration Data	DPT_UCountV alue8_Z

### DHW mode operation via Room Unit

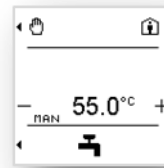
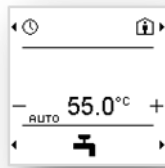

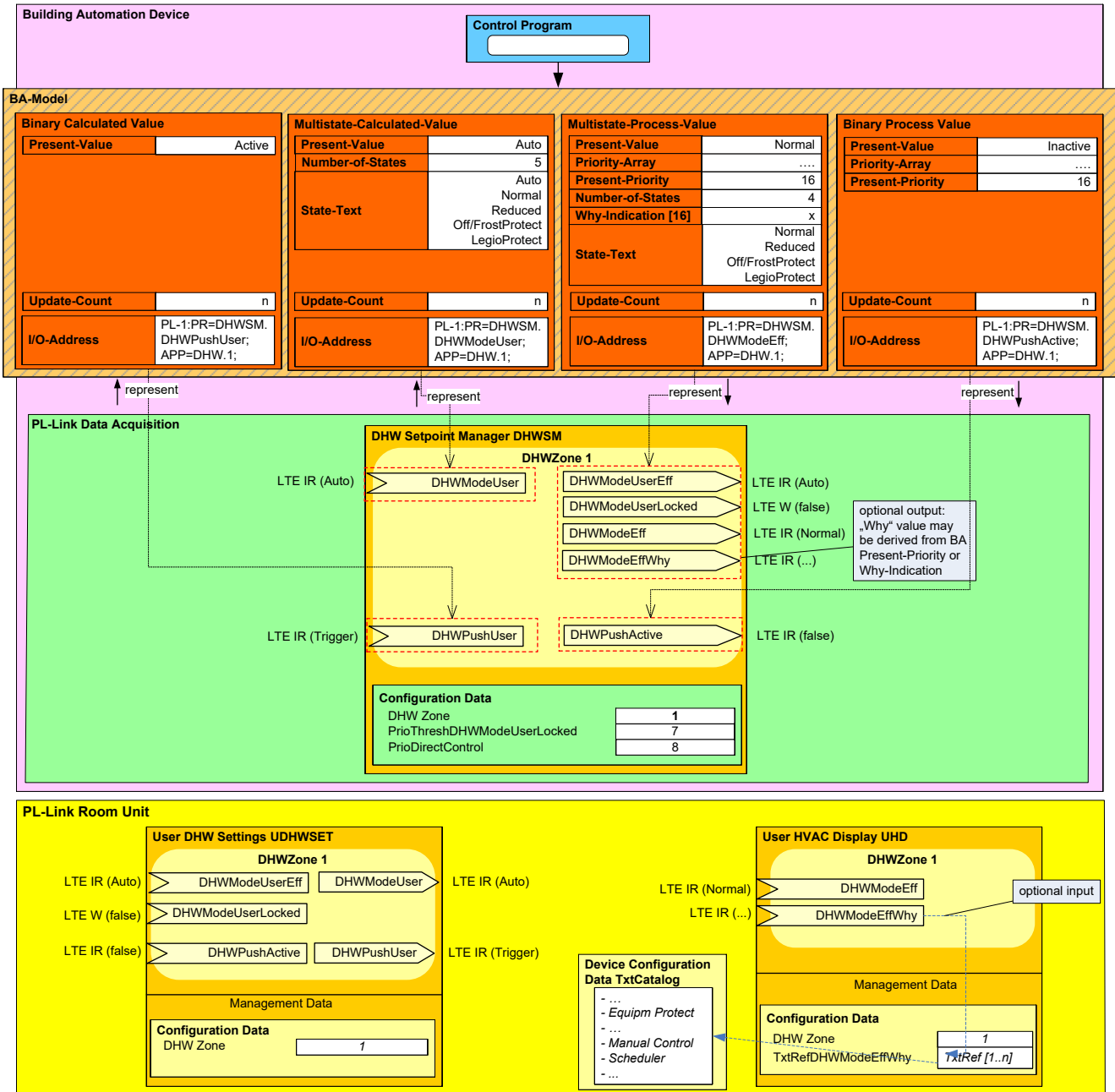

Parameters required to realize the full function:

Property name	Property identifier	Property access	LTE service	Description	KNX Datapoint Type (DPT)
Interface Object Type	1	R	---	390 = UHD	DPT_PropData Type (DPT_ID = 7.010)
DHWModeEff	DHWSM.51	----	IR.ind	Process Data Input	DPT_DHWSMMode_Z
	local copy *)	213	R	---	Diagnostic Value
BuildingZone	101	R/W	---	Configuration Data	DPT_UCountValue8_Z
Room	102	R/W	---	Configuration Data	DPT_UCountValue8_Z
Subzone	103	R/W	---	Configuration Data	DPT_UCountValue8_Z

Property name	Property identifier	Property access	LTE service	Description	KNX Datapoint Type (DPT)
Interface Object Type	1	R	---	181 = UDHWSET	DPT_PropDataType (DPT_ID = 7.010)
DHWModeUse r	51	R	IR.req	Process Data Output	DPT_DHWMode_Z
DHWModeUse rLocked	156	R/W	W.ind	Process Data Input	DPT_Bool
DHWModeUse rEff	DHWSM.56	----	IR.ind	Process Data Input	DPT_DHWMode_Z
	local copy *)	254	R	---	Diagnostic Value
DHWZoneCont roller	101	R/W	---	Configuration Data	DPT_UCountValue8_Z

### Operation of DHW setpoint via Room Unit

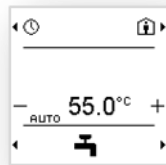



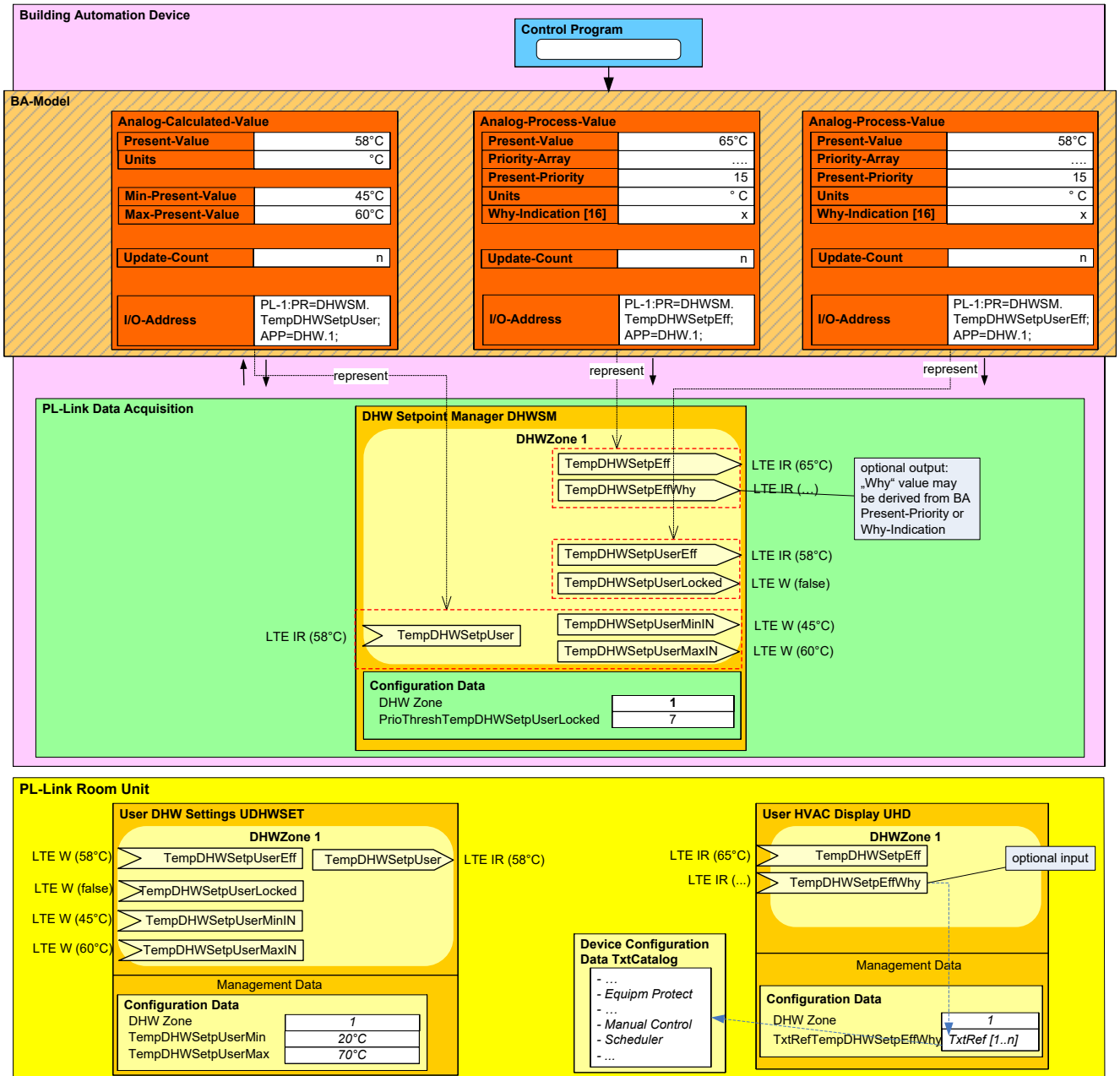

Parameters required to realize the full function:

Property name	Property identifier	Property access	LTE service	Description	KNX Datapoint Type (DPT)
Interface Object Type	1	R	---	390 = UHD	DPT_PropData Type (DPT_ID = 7.010)
TempDHWSetpEff	DHWSM.55	----	IR.ind	Process Data Input	DPT_TempHV ACAbs_Z
local copy *)	211	R	---	Diagnostic Value	
BuildingZone	101	R/W	---	Configuration Data	DPT_UCountV alue8_Z
Room	102	R/W	---	Configuration Data	DPT_UCountV alue8_Z
Subzone	103	R/W	---	Configuration Data	DPT_UCountV alue8_Z

Property name	Property identifier	Property access	LTE service	Description	KNX Datapoint Type (DPT)
Interface Object Type	1	R	---	181 = UDHWSET	DPT_PropData Type (DPT_ID = 7.010)
TempDHWSets pUser	52	R	IR.req	Process Data Output	DPT_TempHV ACAbs_Z
TempDHWSets pUserEff	DHWSM.162	----	IR.ind	Process Data Input	DPT_TempHV ACAbs_Z
local copy *)	246	R	---	Diagnostic Value	
TempDHWSets pUserMinIN	158	R/W	W.ind	Process Data Input, Configuration Data	DPT_TempHV ACAbs_Z
TempDHWSets pUserMaxIN	159	R/W	W.ind	Process Data Input, Configuration Data	DPT_TempHV ACAbs_Z
TempDHWSets pUserLocked	160	R/W	W.ind	Process Data Input	DPT_Bool
DHWZoneController	101	R/W	---	Configuration Data	DPT_UCountValue8_Z

### Visualization of DHW Temperature



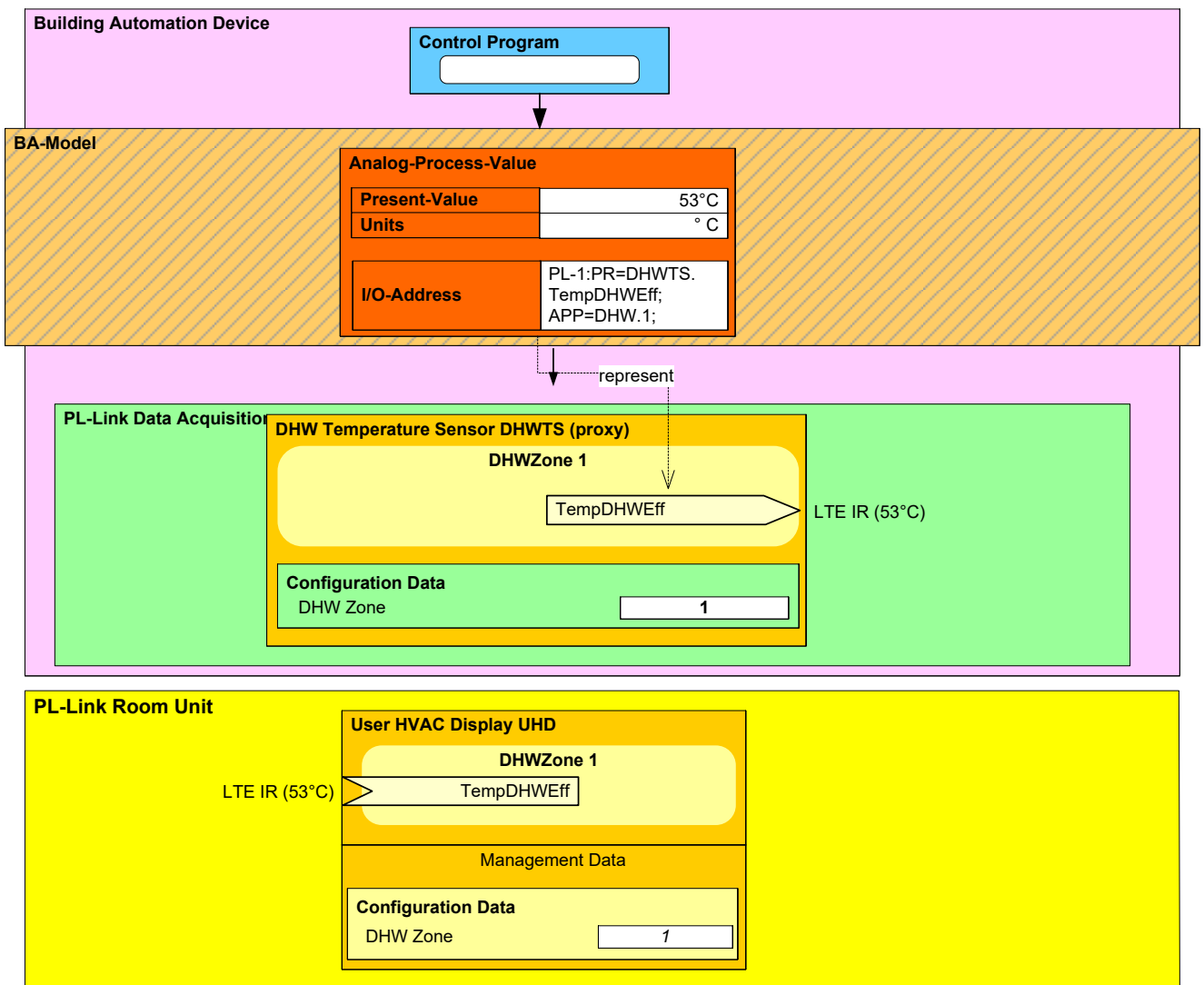

Parameters required to realize the full function:

Property name	Property identifier	Property access	LTE service	Description	KNX Datapoint Type (DPT)
Interface Object Type	1	R	---	390 = UHD	DPT_PropData Type (DPT_ID = 7.010)
TempDHWEff	DHWTS.155	----	IR.ind	Process Data Input	DPT_TempHV ACAbs_Z
local copy *)	210	R	---	Diagnostic Value	
BuildingZone	101	R/W	---	Configuration Data	DPT_UCountV alue8_Z
Room	102	R/W	---	Configuration Data	DPT_UCountV alue8_Z
Subzone	103	R/W	---	Configuration Data	DPT_UCountV alue8_Z

Property name	Property identifier	Property access	LTE service	Description	KNX Datapoint Type (DPT)
Interface Object Type	1	R	---	181 = UDHWSET	DPT_PropData Type (DPT_ID = 7.010)
DHWPushActive	DHWSM.163	----	IR.ind	Process Data Input	DPT_Bool
local copy *)	252	R	---	Diagnostic Value	
DHWZoneController	101	R/W	---	Configuration Data	DPT_UCountValue8_Z

## Scheduler

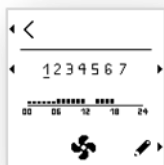

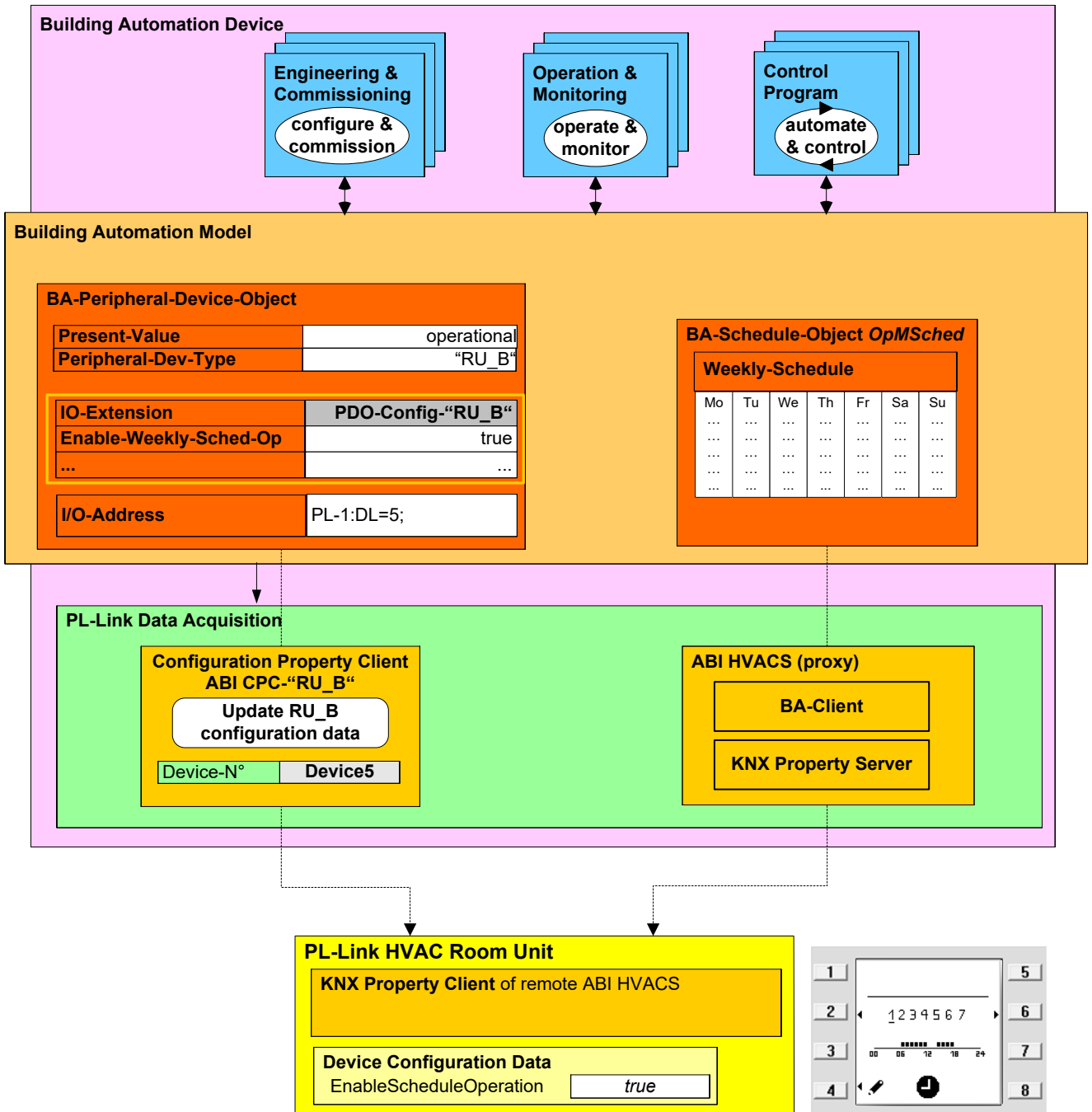

Parameters required to realize the full function:

Property name	Property identifier	Property access	LTE service	Description	KNX Datapoint Type (DPT)
Interface Object Type	1	R	---	110 = HVACS	DPT_PropData Type (DPT_ID = 7.010)
HVACSDailyPr og_Mo 1)	231	R/W	---	Daily Program Monday	DPT_HVACSS witchPoint
HVACSDailyPr og_Tu 1)	232	R/W	---	Daily Program Tuesday	DPT_HVACSS witchPoint
HVACSDailyPr og_We 1)	233	R/W	---	Daily Program Wednesday	DPT_HVACSS witchPoint

Property name	Property identifier	Property access	LTE service	Description	KNX Datapoint Type (DPT)
HVACSDailyProgram_Th 1)	234	R/W	---	Daily Program Thursday	DPT_HVACSSwitchPoint
HVACSDailyProgram_Fr 1)	235	R/W	---	Daily Program Friday	DPT_HVACSSwitchPoint
HVACSDailyProgram_Sa 1)	236	R/W	---	Daily Program Saturday	DPT_HVACSSwitchPoint
HVACSDailyProgram_Su 1)	237	R/W	---	Daily Program Sunday	DPT_HVACSSwitchPoint

### Adjust clock

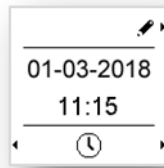

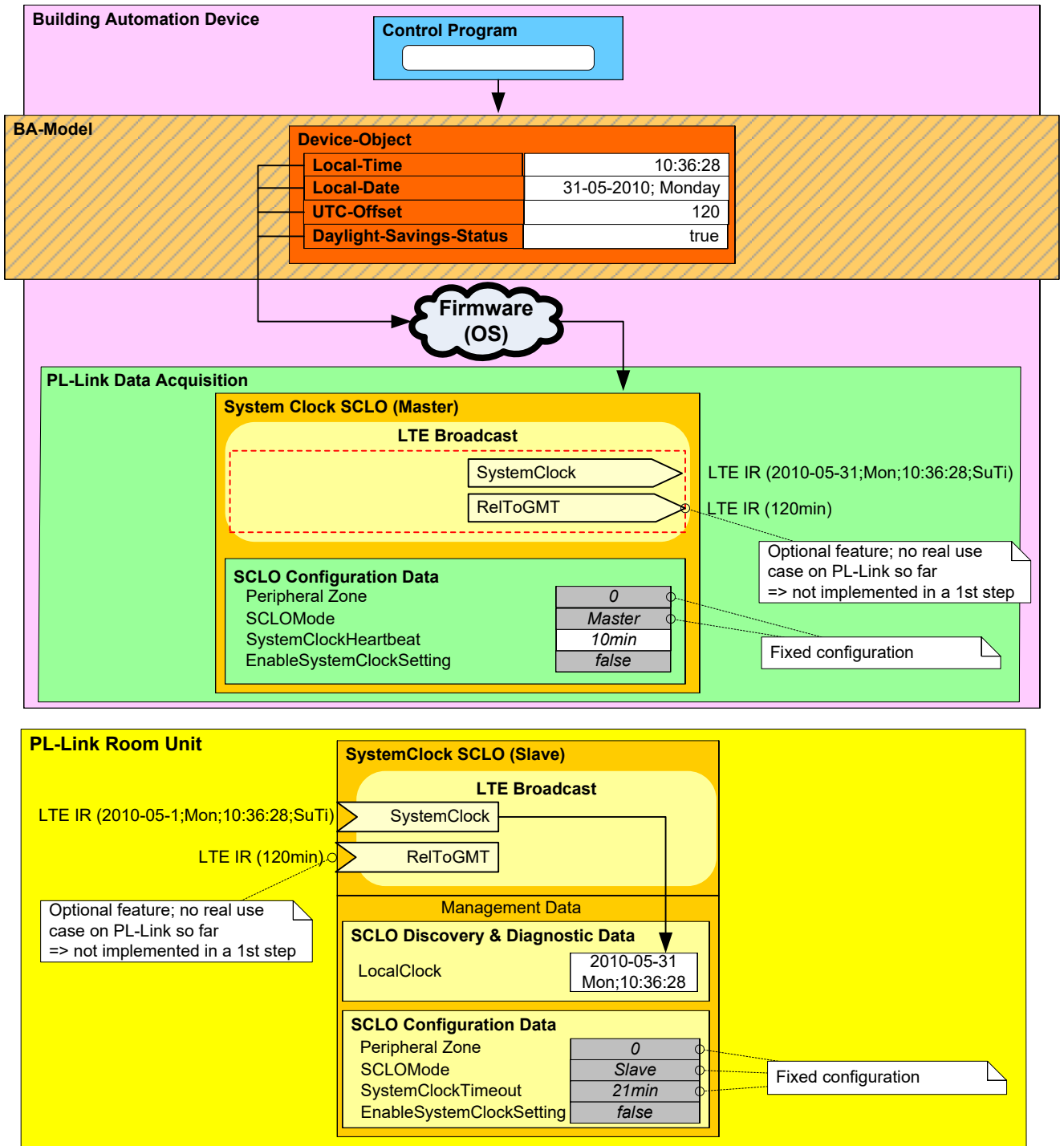

Parameters required to realize the full function:

Property name	Property identifier	Property access	LTE service	Description	KNX Datapoint Type (DPT)
Interface Object Type	1	R	---	1001 = SCLO	DPT_PropData Type
(DPT_ID = 7.010)					
SystemClock	51	R	IR.req	Process Data Output	DPT_DateTime

Notification: Alarm / Service



When alarm is active, the screen blinks until it gets acknowledged.

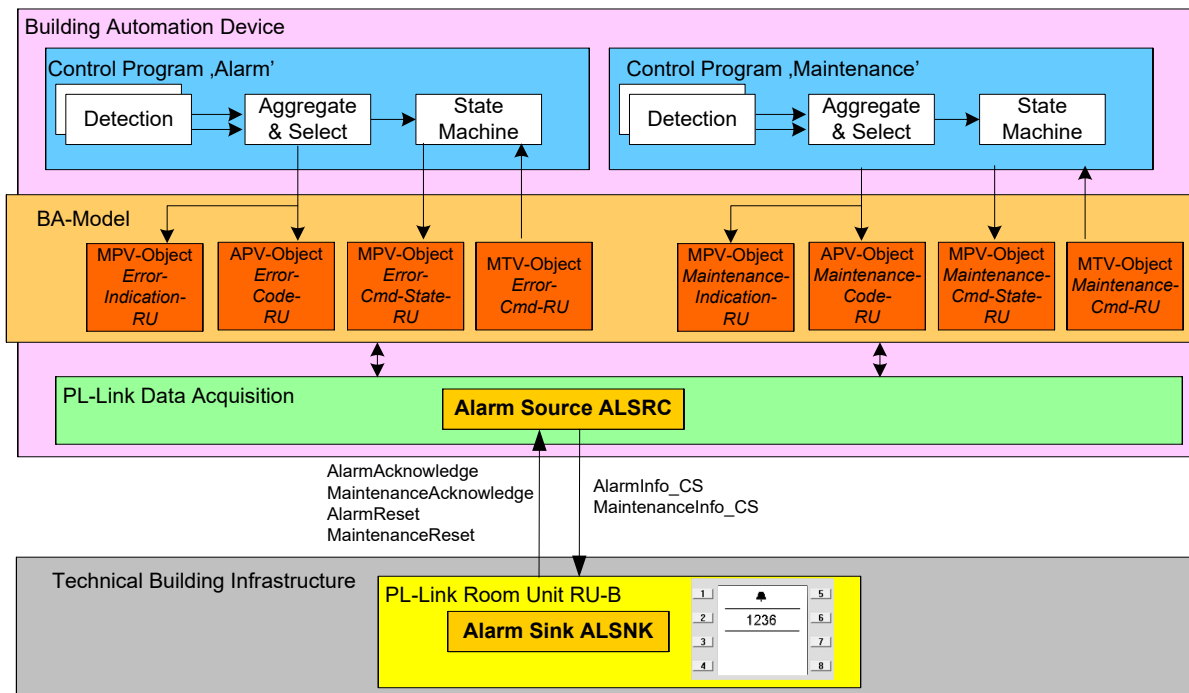

Parameters required to realize the full function:

Property name	Property identifier	Property access	LTE service	Description	KNX Datapoint Type (DPT)
Interface Object Type	1	R	---	1003 = ALSNK device-specific Device Object	DPT_PropData Type (DPT_ID = 7.010)
AlarmInfo_CS	ALSRC.254	---	IR.ind	Process Data Input	DPT_AlarmInfo_CS
local copy 1)	230	R	---	Diagnostic Value	
AlarmAcknowledge	ALSRC.55	---	W.req	Process Data Output	DPT_Ack
local copy 2)	228	R	---	Diagnostic Value	
AlarmReset	ALSRC.56	---	W.req	Process Data Output	DPT_Reset



Property name	Property identifier	Property access	LTE service	Description	KNX Datapoint Type (DPT)
local copy 2)	229	R	---	Diagnostic Value	
MaintenanceInfo_CS	ALSRC.194	---	IR.ind	Process Data Input	DPT_AlarmInfo_CS
local copy 1)	227	R	---	Diagnostic Value	
MaintenanceAcknowledgement	ALSRC.192	---	W.req	Process Data Output	DPT_Ack

Property name	Property identifier	Property access	LTE service	Description	KNX Datapoint Type (DPT)
	local copy 2)	225	R	---	Diagnostic Value
MaintenanceReset	ALSRC.193	---	W.req	Process Data Output	DPT_Reset
	local copy 2)	226	R	---	Diagnostic Value

### Auxiliary input

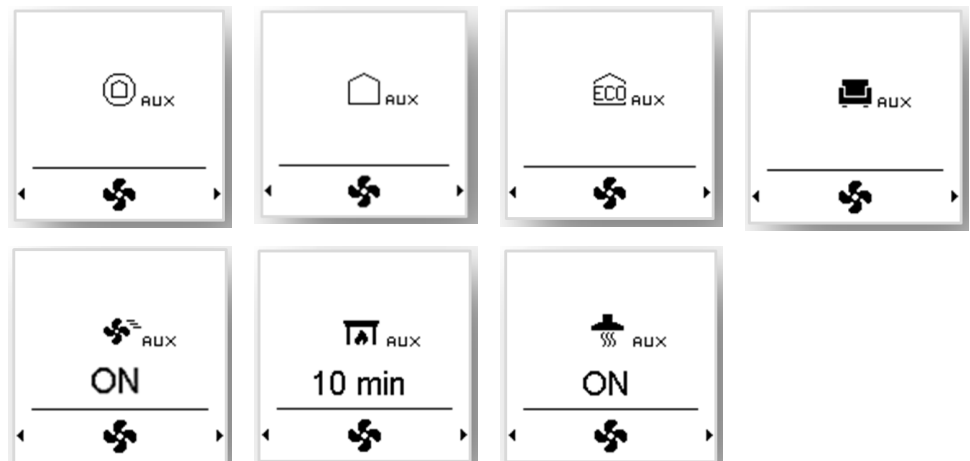

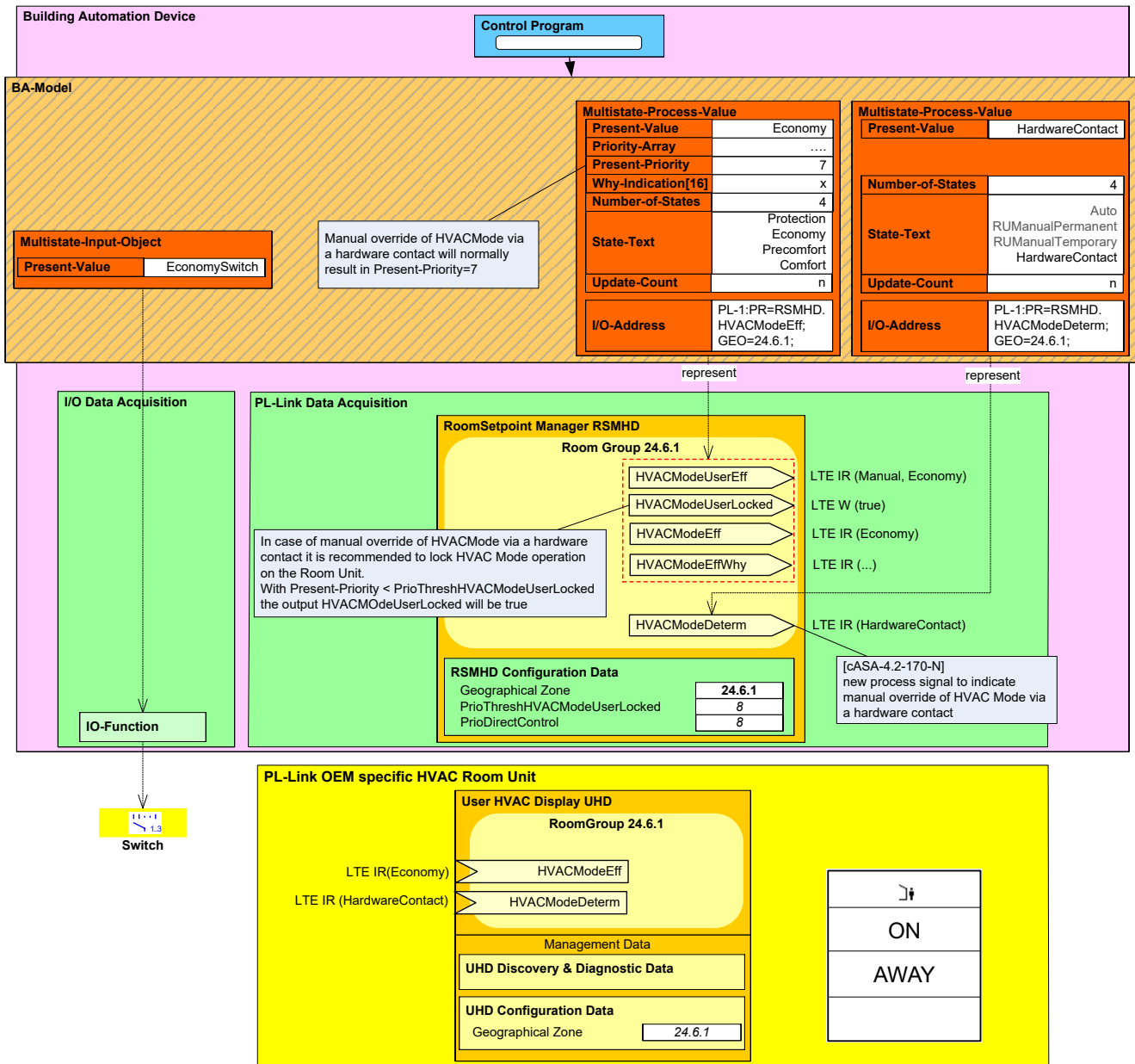

Parameters required to realize the full function:

Property name	Property identifier	Property access	LTE service	Description	KNX Datapoint Type (DPT)
Interface Object Type	1	R	---	390 = UHD	DPT_PropData Type (DPT_ID = 7.010)
HVACModeEff	RSMHD.51	----	IR.ind	Process Data Input	DPT_HVACMode_Z
local copy *)	163	R	---	Diagnostic Value	
HVACModeDeterm	RSMHD.243	----	IR.ind	Process Data Input	DPT_HVACModeDeterm
local copy *)	217	R	---	Diagnostic Value	

---

Property name	Property identifier	Property access	LTE service	Description	KNX Datapoint Type (DPT)
BuildingZone	101	R/W	---	Configuration Data	DPT_UCountValue8_Z
Room	102	R/W	---	Configuration Data	DPT_UCountValue8_Z
Subzone	103	R/W	---	Configuration Data	DPT_UCountValue8_Z

## 6 Commissioning

### Prerequisites

Before commissioning a room operator unit, make sure an application is downloaded onto the connected controller, from where the functions are downloaded into the room operator unit.

After successful commissioning, the room operator unit displays the default operating page defined in the application loaded in the controller.

### Automatic commissioning (1:1 connection)

In a 1:1 connection, i.e. only one room operator unit connecting to one controller, when powered up via the KNX bus for the first time, the room operator unit automatically commissions itself.

After successful commissioning, the room operator unit displays the default operating page defined in the application loaded in the room automation station.

### 6.1 Programming pin and service LED

The devices come with a programming pin and a red service LED on the rear.

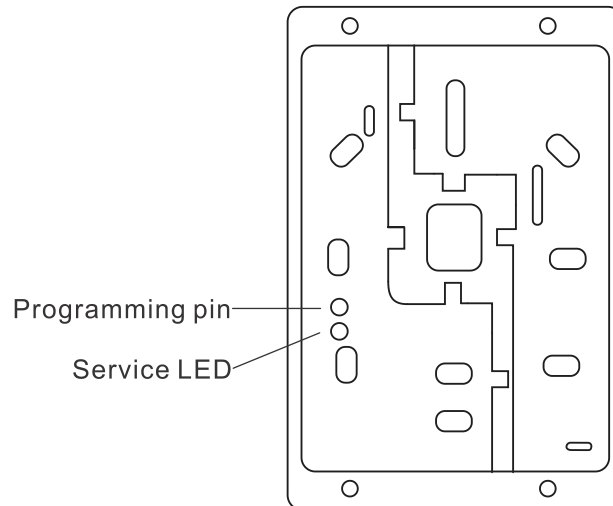

#### 6.1.1 Addressing

1. Briefly press the programming pin (< 2 s).
  - ⇒ The device enters programming mode; the service LED is continuously on. The tool identifies and assigns the currently active device.
2. After the device is commissioned, deactivate programming mode by shortly pressing the programming pin (< 2 s). The service LED goes off.

#### Note:

- **Programming mode returns to “disabled” each time the device restarts.**
- **Addressing and commissioning can be done automatically if a POS3.xx15 is connected to the device.**

#### 6.1.2 Connection test

1. Press the programming pin (>5 s and <20 s) to test the KNX PL-Link connection. After releasing the programming pin, testing of the KNX PL-Link connection starts; the service LED flashes (1/4 s on, 7/4 s off). After approximately 12 s, the test result is displayed:

- If the test is positive, the LED is lit continuously.
  - If the test fails, the LED flashes (1 s on, 1 s off).
2. Briefly press the programming pin (<2 s) to stop displaying the result of the connection test. The service LED goes off.

### 6.1.3 Reset to factory setting

Press the programming pin (>20 s). The device is locked and reboots within 8 s. The controller removes it from its device list. During this time, the device can safely be removed from the network.

**NOTICE! The LED is off during this procedure.**

If the bus plug remains connected, the device acts like a newly inserted device requiring automated or manual configuration.

<b>!</b>	<b>NOTICE</b>
	<b>This operation resets all user-defined data and configuration settings to factory default.</b> This operation is irreversible.

## 7 Technical data

Power supply	
Operating voltage	KNX PL-Link DC 21...30 V
Max power consumption	7...10 mA

Interfaces	
Type of port between controller and room operating unit KNX PL-Link	KNX PL-Link
Baud rate	9.6 kbps
Protocol	KNX PL-LINK
Standard KNX connector	Wire diameter 0.8 mm, max. 1.0 mm (solid conductors only)
Cable type	2-core twisted pair, stranded, solid
Single cable length (from room automation station to room operating unit)	<1000 m
Section	0.5...1.5 mm <sup>2</sup>
Bus line polarity	PL+, PL-
Bus terminating resistor	not required

Sensor data		
Temperature Sensor	Measuring element	NTC resistance sensor
	Measuring range	0...50 °C
	Measuring accuracy (5...30 °C)	±0.8 °C
	Measuring accuracy (25 °C)	±0.5 °C
Humidity Sensor (only for POS8.4440/109)	Measuring range	10 %...95 % r.h.
	Accuracy (r.h. 20 %...80 %)	±4 % at 25 °C
	Accuracy (r.h. 0 %...20 %, 80 %...95 %)	±6 % at 25 °C

Ambient conditions and protection classification	
Housing protection Protection standard as per EN 60529	<ul style="list-style-type: none"> <li>IP30</li> <li>IP33 for surface part</li> </ul>
Insulation protection class	Class III
Climatic ambient conditions <ul style="list-style-type: none"> <li>Normal operation</li> <li>Transport</li> </ul>	<ul style="list-style-type: none"> <li>Environmental conditions: Class 3K5 Temperature 0...50 °C Air humidity &lt;85% r.h.</li> <li>Environmental conditions: Class 2K3 Temperature -25...70 °C Air humidity &lt;95% r.h.</li> </ul>
Mechanical ambient conditions Normal operation Transport	Class 3M2 Class 2M2

Standards, directives and approvals	
EU conformity (CE)	A6V11210253 *)
RCM conformity to EMC emission standard	A6V11210257 *)
IC Compliance	CAN ICE-3(B)/NMB-3(B)
UL Compliance	UL916
FCC Compliance	Part 15 of the FCC rules. Operation is subject to the following two conditions: 1) this device may not cause harmful interference, and 2) this device must accept any interference received, including interference that may cause undesired operation.
Environmental compatibility	The product environmental declaration (A6V10733777 *) contains data on environmentally compatible product design and assessments (RoHS compliance, materials composition, packaging, environmental benefit, disposal).

\*) Documents can be downloaded at the following address:

<http://siemens.com/bt/download>

<b>!</b>	<p><b>NOTICE</b></p> <p>This equipment has been tested and found to comply with the limits for a Class B digital device, pursuant to Part 15 of the FCC Rules. These limits are designed to provide reasonable protection against harmful interference in a residential installation. This equipment generates, uses and can radiate radio frequency energy and, if not installed and used in accordance with the instructions, may cause harmful interference to radio communications. However, there is no guarantee that interference will not occur in a particular installation. If this equipment does cause harmful interference to radio or television reception, which can be determined by turning the device off and on, the user is encouraged to try to correct the interference by one or more of the following measures:</p> <ul style="list-style-type: none"> <li>● Reorient or relocate the receiving antenna.</li> <li>● Increase the separation between the equipment and receiver.</li> <li>● Connect the equipment into an outlet on a circuit different from that to which the receiver is connected.</li> <li>● Consult the dealer or an experienced radio/TV technician for help.</li> </ul>
----------	---

General data (POS8.4420/109)	
Color	Signal white (RAL9003)
Weight	145 g

General data (POS8.4440/109)	
Color	Signal white (RAL9003)
Weight	146 g

## 8 Functions

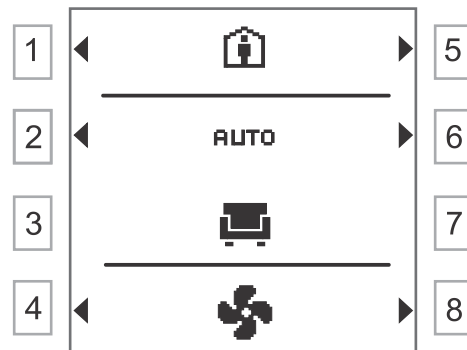

Elements	Functions
	Home mode / Away mode / Temporary mode
	Temporary mode: Ventilation boost / Fire place
	HVAC Mode: Comfort / Economy / Unoccupied / Protection
AUTO / MAN	Auto / Manual
	Manual
	Ventilation page
	Temperature page
	Domestic hot water page
	Notification page
	Clock page
	General page / Expert page
	Indicates an operable element
	Wait
	Start
	List
	Alarm (A-alarm) notification abnormal and unacknowledged
	Alarm (A-alarm) notification normal and unacknowledged
	Alarm (A-alarm) notification abnormal and acknowledged
	Alarm (A-alarm) notification normal and acknowledged
	Service (B-alarm) notification abnormal and unacknowledged
	Service (B-alarm) notification normal and unacknowledged
	Service (B-alarm) notification abnormal and acknowledged
	Acknowledge all notifications
	Reset
	Confirm



Elements	Functions
	Cancel
	Go back
	Exit / next
	Increase / decrease
	Add a switch point
	Edit
	Delete
1 2 3 4 5 6 7	1=Monday, 2=Tuesday, ..., 6=Saturday, 7=Sunday
00 06 12 18 24	Time
	Switch point
	Time scheduler bar
	Read parameter mode
	Outside temperature
	Room temperature
	Auxiliary input for comfort mode
	Auxiliary input for economy mode
	Auxiliary input for unoccupied mode
	Auxiliary input for protection mode
	Auxiliary input for ventilation boost mode
	Auxiliary input for fire place mode
	Auxiliary input for kitchen hood mode

## 9 Operation

### 9.1 Ventilation page

#### Start-up page

When the device is switched on, the startup page displays product-related information including product model, software version, and SN number for 3 seconds. Then the screen turns to the home page.

#### In home mode

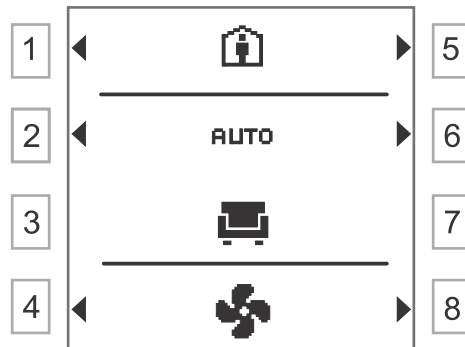

Buttons 1 and 5	Toggle through home mode, temporary mode and away mode
Buttons 2 and 6	Toggle between auto mode and manual mode
Buttons 3 and 7	<ul style="list-style-type: none"> <li>In auto mode: No function (no arrow symbols displayed)</li> <li>In manual mode: Toggle through HVAC mode: comfort, economy, unoccupied, and protection</li> </ul>
Button 4 and 8	Toggle through different pages: Ventilation, temperature, domestic hot water, notification and clock

#### In temporary mode

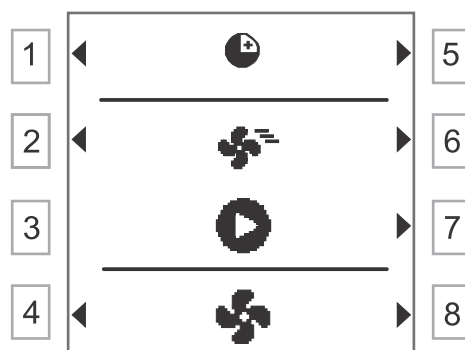

Button 1 and 5	Toggle through home mode, temporary mode and away mode
Button 2 and 6	Toggle between temporary modes: Ventilation boost and fire place
Button 3	No function (no arrow symbol displayed)
Button 7	Press to start the selected temporary mode: Ventilation boost or fire place
Button 4 and 8	Toggle through different pages: Ventilation, temperature, domestic hot water, notification and clock.

### In away mode

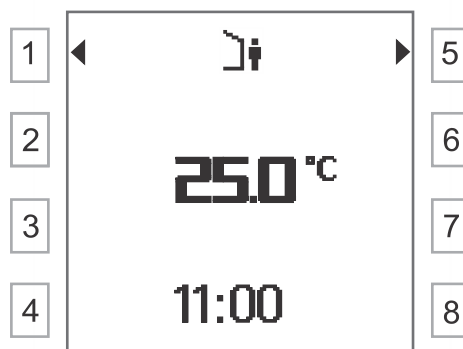

Buttons 1 and 5	Toggle through home mode, temporary mode and away mode
Buttons 2, 3, 4, 6, 7 and 8	No function (no arrow symbols displayed)

## 9.2 Temperature page

### In home mode

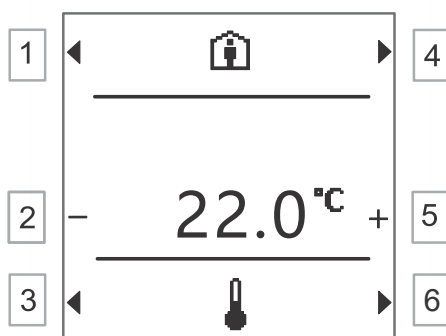

Buttons 1 and 4	Toggle through home mode, temporary mode and away mode
Buttons 2 and 5	Increase or decrease the temperature
Buttons 3 and 6	Toggle through different pages: Ventilation, temperature, domestic hot water, notification and clock

## 9.3 Domestic hot water page

### In home mode

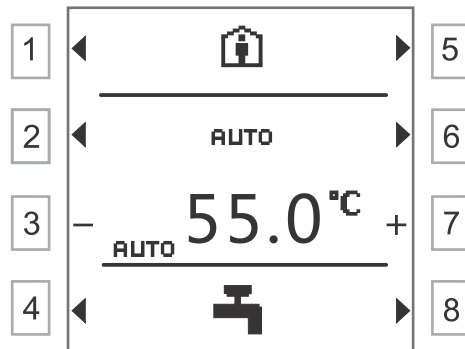

Buttons 1 and 5	Toggle through home mode, temporary mode and away mode
Buttons 2 and 6	Toggle between auto mode and manual mode
Buttons 3 and 7	Increase or decrease temperature
Buttons 4 and 8	Toggle through different pages: Ventilation, temperature, domestic hot water, notification and clock

### In temporary mode

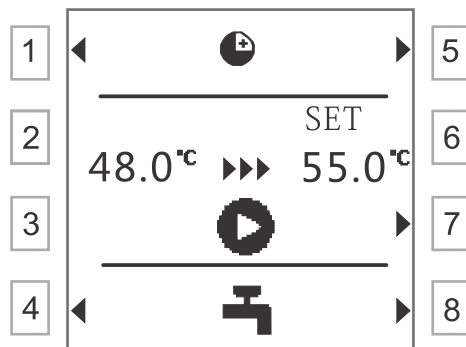

Buttons 1 and 5	Toggle through home mode, temporary mode and away mode
Buttons 2, 3 and 6	No function (no arrow symbol displayed)
Button 7	Press to start the selected temporary mode: Domestic hot water
Buttons 4 and 8	Toggle through different pages: ventilation, temperature, domestic hot water, notification and clock.

## 9.4 Notification page

Press button 4 or 8 from the default page to enter the notification page.

With no pending notification, the following is displayed:

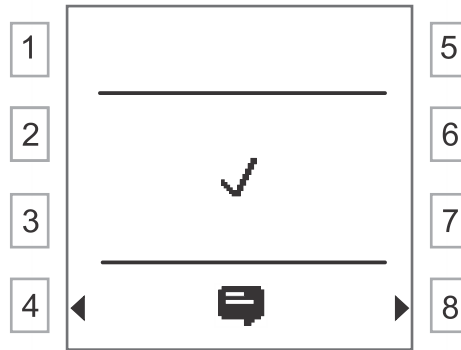

**Alarm notification**

When an  event comes in, e.g., event number 1236, the following is displayed. The screen blinks until it gets acknowledged.

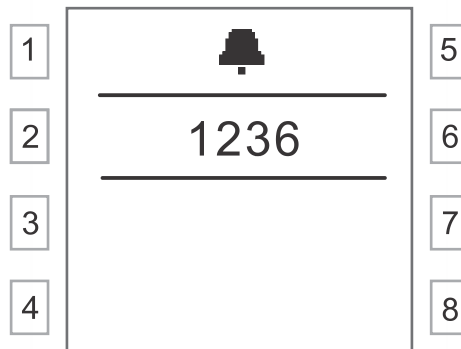

Press any button to enter the next page:

**Note:**  1 stands for type 1: Alarm notification. When a new alarm comes in, it overrides the existing one. The screen continues to show type 1.

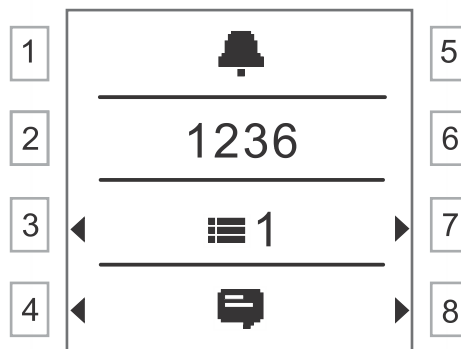

Press button 3 or 7 to go to the following page.

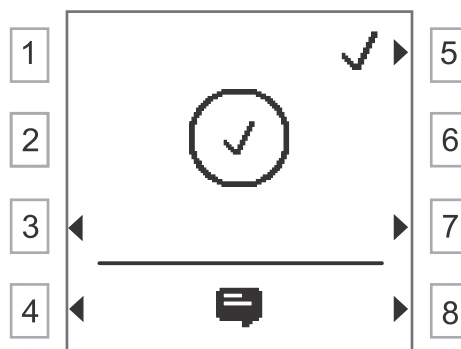

Then press button 5 to send a request to the controller to acknowledge all alarms. The following is displayed while waiting for the feedback from the controller.

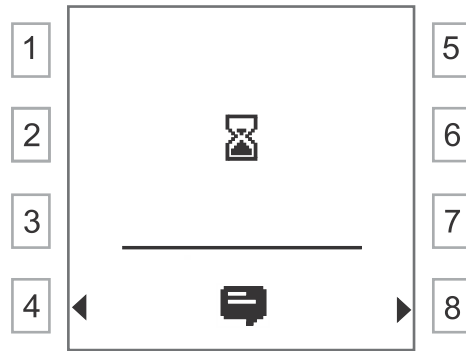

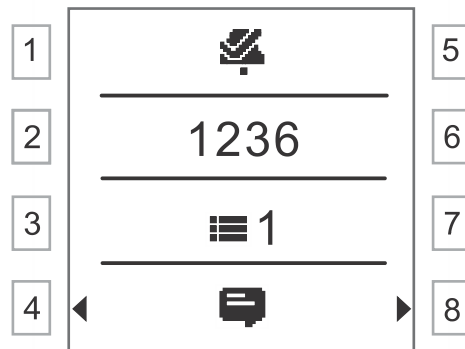

The following is displayed automatically after all alarms are acknowledged.

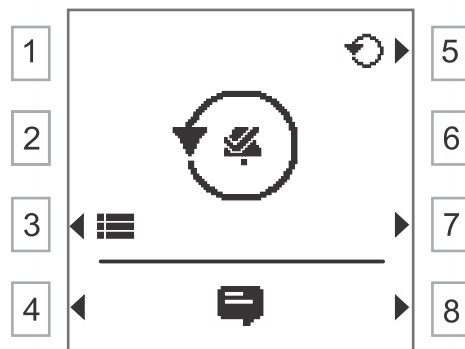
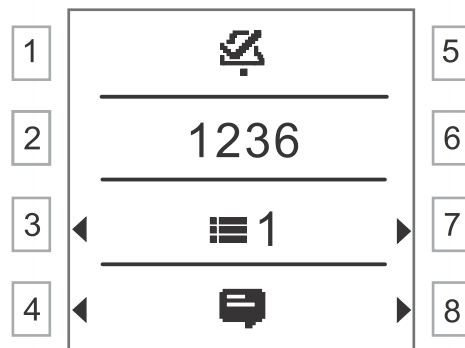

With only  notifications left, press button 7 to enter the reset page.

On the reset page, press 3 or 7 to switch between notification and reset page.



The  notifications are deleted after resetting and the screen returns to the notification page.

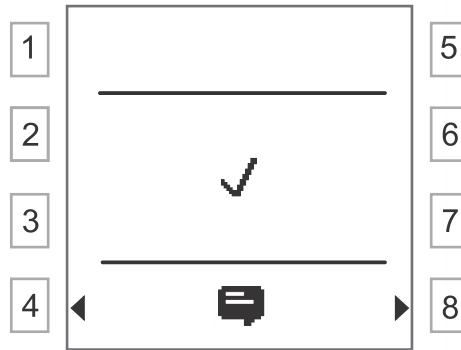

**Service notification**

For events , , , , or , there is no pop up screen. To check the notifications, press button 4 or 8 on the default page to enter the notification page as below:

**Note:** 2 stands for type 2: Service notification. A new service notification overrides the existing one. The screen continues to show type 2.

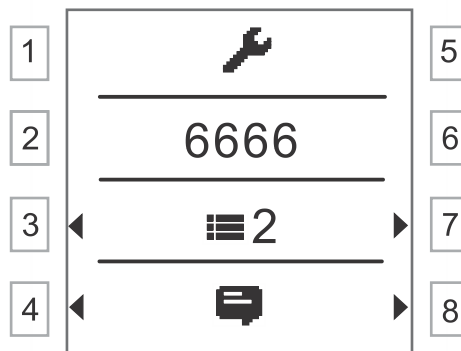

With unacknowledged notifications, press button 7 to go to the following page:

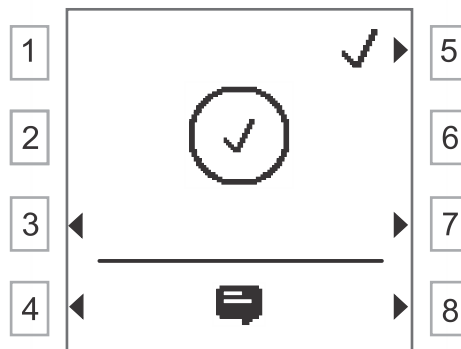

Press button 5 to send a request to the controller to acknowledge all notifications. The following page is displayed while waiting for the feedback from the controller.

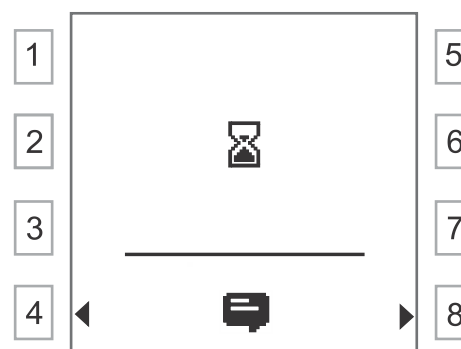

The following is displayed automatically after all notifications are acknowledged.



Service notifications disappear and the screen returns to the notification page after the device receives a maintenance, normal and Acked (acknowledged) feedback from the controller.

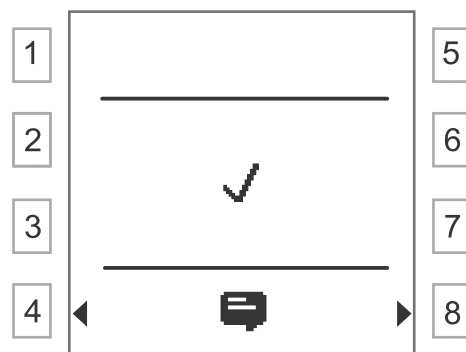

## 9.5 Clock page

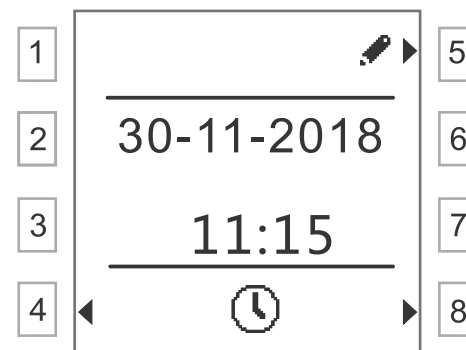

Buttons 1, 2, 3, 6, and 7	No function (no arrow symbols displayed)
Button 5	Press to edit the time and date
Buttons 4 and 8	Toggle through different pages: Ventilation, temperature, domestic hot water, notification and clock

## 9.6 Scheduler settings

From the default page, long-press button 2 to enter the scheduler settings for ventilation:



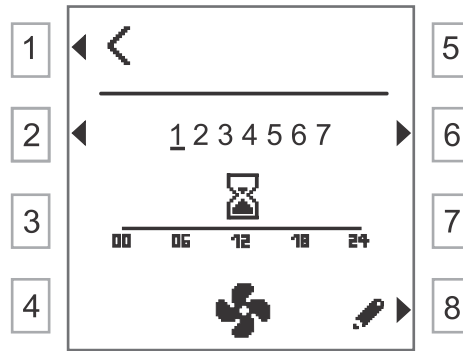

Button 1	Press to exit and save the settings
Buttons 2 and 6	Press to select a weekday
Buttons 3, 4, 5 and 7	No function (no arrow symbols displayed)
Button 8	Press to edit the scheduler settings for the selected weekday

From the above page, press button 8 to enter the following page to further edit the scheduler:

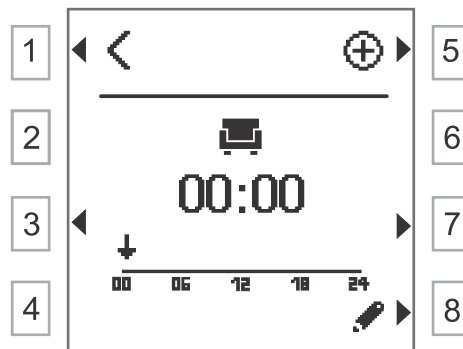

Button 1	Press to exit and save the settings
Buttons 2, 4 and 6	No function (no arrow symbol displayed)
Buttons 3 and 7	Toggle through switch points
Button 5	Press to add a switch point
Button 8	Press to edit the switch point



A maximum of 15 switching points can be added.

## 9.7 Standard and expert settings

### Standard settings

From the default page, long-press button 8 to enter the standard settings page as below:

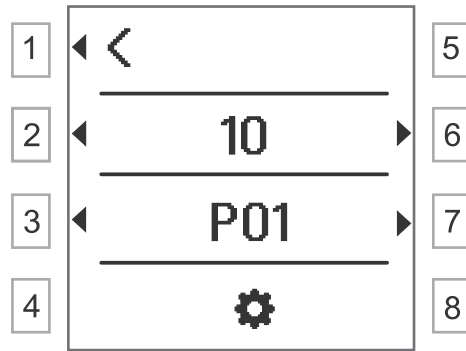

Button 1	Press to exit and save the settings
Buttons 2 and 6	Press to select a setting
Buttons 3 and 7	Toggle through the parameters
Buttons 4, 5 and 8	No function (no arrow symbols displayed)

### Expert settings

From the default page, long-press buttons 6 and 8 simultaneously to enter the expert settings page:

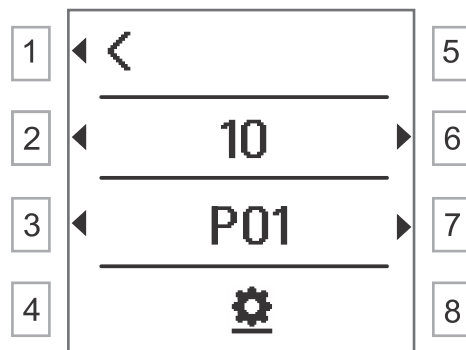

Button 1	Press to exit and save the settings
Buttons 2 and 6	Press to select a setting
Buttons 3 and 7	Toggle through the parameters
Buttons 4, 5 and 8	No function (no arrow symbols displayed)



For detailed information about the parameters, refer to Parameters [→ 52].

## 9.8 Standby page

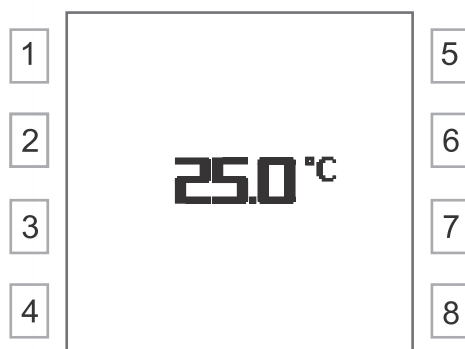

When no operation occurs on the screen for a while, the room operator units turns off backlighting and displays the standby page automatically. There are 5 types of standby pages. Users can select from the standard settings P02.

Press any button to activate backlighting and any button again to enter the default page.

## 10 Appendix

### 10.1 Parameters

#### Parameters for standard settings

Parameters	Description	Default
P01	Backlighting level: 1, 2, ..., 10	5
P02	Standby page types: 1, 2, ..., 5 1: room temperature 2: room temperature and time 3: room temperature, time and outside air temperature 4: room temperature, time, outside air temperature and customer logo 5: room temperature, time, outside air temperature and relative humidity	1
P03	Room operator unit temperature correction: -3.0...3.0 K	0.0 K
P04	Temperature unit: °C and °F	°C
P05	Date format: DD-MM-YYYY; MM-DD-YYYY; YYYY-MM-DD	DD-MM-YYYY

#### Parameters for expert settings

Parameters	Description	Default
P01...P05	As above	As above
P51	Restart the room operator unit by pressing button 6	N/A

### 10.2 Object list

ObjType	ObjInstance	ObjIdx	Function Block	Property	PID	ArraySize	PDT/DPT	R/W	LTE-Service	Description	Comments
0	1	0	DeviceObject	PID_OBJECT_TYPE	1	1	U16 / PDT_UNSIGNIED_INT	R	----		Device object: SD-T060.0601_EN_SARB_Data_Acquisition 7.1.2.9.1
				PID_SERIAL_NUMBER	11	1	N16U32 / PDT_GENERIC_06, [DPT_SerNum (DPT_ID = 221.001)]	R	----	KNX Serial Number of the device in which it is contained	
				PID_MANUFACTURER_ID	12	1	U16 / PDT_UNSIGNIED_INT	R	----	Code assigned by the KNX Association to identify the manufacturer of the device. 253 / 0x00FD = Siemens Schweiz AG	
				PID_DEVICE_CONTROL	14	1	B8 / PDT_BITSET8 [DPT_Device_Control	RW	----	VerifyMode Control for UserMemory_Write Service is done via this property. Bit2 is	KNX Standard: chapter 3-5-1, clause 4.2.14 PID_DEVICE_CONTR

						(DPT_ID = 21.002)]			the Verify-Mode Flag. When using connectionless UserMemWrite, then verifyMode shall be active	OL chapter 3-5-2, clause 3.19 DM_UserMem_Write	
				PID_ORDER_INFO	15	1	PDT_GENERIC_10 DPT_OrderInfo (DPT-ID = 60110.60002)	R	----	manufacturer specific Order Information	DPT-ID out of proprietary range, as Specified in Synco
				PID_ROUTING_COUNT	51	1	U8 / PDT_UNSIGN ED_CHAR	RW	----	This Property shall include the default value for the hop count. (This is a parameter for the Network Layer of the device.). It shall be used to adjust the default value of the hop count parameter of the Network Layer	KNX Standard, chapter 3-5-1, clause 4.3.2 PID_ROUTING_COUNT
				PID_PROG_MODE	54	1	B8 / PDT_BITSET8	RW	----	Bit 0 = Programming Mode all other bits reserved for future use	
				PID_PRODUCT_ID	55	1	PDT_GENERIC_10 DPT_Product_I dentification (DPT-ID = 60110.60002)	R	----	manufacturer specific device type For this property, Synco rules apply: Serial Number, Device Family, Device Variant (concatenated)	DPT-ID out of proprietary range, as Specified in Synco
				PID_MAX_APDU_LENGTH	56	1	U16 / PDT_UNSIGN ED_INT	R	----	maximal supported APDU-length for management of the device	Default = 60 bytes
				PID_SUBNET_ADDR	57	1	U8 / PDT_UNSIGN ED_CHAR	R	----	Subnetwork Address part (high octet) of the Individual Address	
				PID_DEVICE_ADDR	58	1	U8 / PDT_UNSIGN ED_CHAR	R	----	Device Address part (low octet) of the Individual Address	
				PID_IO_LIST	71	25	U16 / PDT_UNSIGN ED_INT[]	R	----	Array which lists for each object index the Object Type	acc. KNX Standard, chapter 3/5/1 Resources, PID_IOLIST
				DevIdent	241	1	U16U32U8N8 / PDT_GENERIC_08	R	IR.req	Used for SARB localization, communication test. Sent with an LTE-InfoReport after power up and periodically if DevIdentAutoSend is enabled	
				DevIdentAutoSend	242	1	B1 / PDT_BINARY_I NFORMATION B1 / DPT_Enable	RW	----	Enables PID_DEVICE_IDENT to be sent spontaneously at power up and in regular intervals	DPT definition: SD-T060.0601_EN_SARB_Data_Aquisition 7.1.2.9.3
				DevIdentHopCountType	243	1	N8 / PDT_ENUM8 DPT_HopCount	RW	----	Defines the used hop count for DevIdent: 0: PSD defined 1: 0	DPT definition: SD-T060.0601_EN_SARB_Data_Aquisition

							Type			7: 7 All others: reserved	7.1.2.9.3
				DevIdentTrigger	24 4	1	B1 / PDT_BINARY_I NFORMATION B1 / DPT_Trigger	RW	W.in d	Triggers sending of DevIdent when DevIdentAutoSend is false. This is an LTE-Write- Input	
				ConnectionTestState	24 5	1	N8 / PDT_ENUM8 DPT_Connectio nTestState	RW	----	Used for Feedback from AD during connection test. 0: PSD written value, No test in progress 1: AD written value, Connection OK. 2: PSD written value, Test in Progress	DPT definition: SD- T060.0601_EN_SARB _Data_Aquisition 7.1.2.9.3
				DevTypeID	24 6	1	N16U32 / PDT_GENERIC _06 DPT_DeviceTy peID	R	----	Used for device type identification and compatibility check between configuration data and device capabilities (Interface / Object List Version)	DPT definition: SD- T060.0601_EN_SARB _Data_Aquisition 7.1.2.9.3
3	1	7	Applicati on Program Object	Interface Object type	1	1	U16 / PDT_UNSIGNE D_INT	R	----	Device Management, access (write) by ETS during download (apartly part of S- Mode Interface)	belongs to S-Mode Interface
				PID_LOAD_ STATE_CON TROL	5	1	PDT_CONTRO L DPT_LoadCont rol (DPT-ID = 20.60081)	RW	----	[Wichert, Stefan] APO- LSM will be used for download control of parameter properties for AB's RTS, UHRS, UHD, ... <b>This property shall be reserved for ETS tool in S-Mode. An empty LSM transformation function shall be implemented to keep compliant with KNX specification.</b>	KNX DOC 03_05_01 DPT-ID out of proprietary range, as Specified in Synco
50100	1	9	Extende d Device Object	Interface Object type	1	1	U16 / PDT_UNSIGNE D_INT	R	----		
				PID_LOAD_ STATE_CON TROL	5	1	PDT_CONTRO L DPT_LoadCont rol (DPT-ID = 20.60081)	RW	----	LSM for control of FW upgrade	common use intended for devices from I BT CPS supporting FW- Upgrade
				ObjectIndex	29	1		R	Rea d.ind		
				Apartment	10 1	1	U8Z8 / DPT_UcountVa lue8_Z	RW	----		
				Room	10 2	1	U8Z8 / DPT_UcountVa lue8_Z	RW	----		
				Subzone	10 3	1	U8Z8 / DPT_UcountVa	RW	----		

							lue8_Z				
				ACS Product ID	51	1	PT_GENERIC_12 DPT_AcsProductId (DPT-ID = 60112.60000)	R	----	Contains serial no., device family etc. is constant for a given device. For more details, see Synco specification documents	DPT-ID out of proprietary range, as Specified in Synco
				PlantImageIdentification	53	1	DPT_GENERIC_10	R	----		
				Device Ident	90	1	DPT_GENERIC_10	R	----		
				VersionArray	91	1	U5U5U6 / DPT_Version	R	----	Array-Field with Index 1: Firmware-Version of the Device; Additional Array-Fields may be used for further version-info, e.g. HW-Version	M.V.R (U5U5U6). Here M(magic) is not used. V(version).R(Revision) before formal release is 0.1
				FW_Upgrade_Checksum	12	16	PT_UNSIGNED_CHAR	R	----	Checksum for FW upgrade. The checksum algorithm is MD2.	
				FW_Upgrade_Length	12	2	U32 / PDT_UNSIGNED_LONG DPT_Value_4_Ucount (12.001)	R	----	New FW image file length	
				AutoSyncAddress	12	3	B1 / DPT_Enable	RW	----	- 0 Disable the auto synchronize the ARS address to RTS, RAQS and RRHS - 1 Enable the auto synchronize the ARS address to RTS, RAQS and RRHS	
65533	1	10	"Application Block Alarm Source /	Interface Object type	1	1	U16 / PDT_UNSIGNED_INT	R	----	Devices that do not support the Application Block Alarm Source, shall also insert a placeholder Application Block / KNX Interface Object (Object Type SUBSTITUTE, ID=65'533) in its place	PLACE HOLDER!!
52318	1	11	POS89 DO Device Object	Interface Object type	1	1	U16 / PDT_UNSIGNED_INT	R	----	This object is used for Device Locking Function (LTE- Runtime Command in Geographical Zone) and holds all RU device specific parameters, such as backlight setting, sound setting etc.	
				PID_LOAD_STATE_CONTROL	5	1	PDT_CONTROL DPT_LoadControl (DPT-ID = 20.60081)	RW	----	LSM for control of the bootloader	
				ObjectIndex	29	1	U8 / PDT_UNSIGNED	R	Rea	needed for Object Index Discovery via	=> SD-T060.0601_EN_SARB

						D_CHAR U8 / DPT_Value_1_ Ucount		d.ind	LTE-Read onto this Property	_Data_Aquisition: 7.1.2.10.1 KNX Standard, chapter 3-5-1, PID_OBJECT_INDEX
				Apartment	10 1	1	U8Z8 / DPT_UcountVa lue8_Z	RW	----	
				Room	10 2	1	U8Z8 / DPT_UcountVa lue8_Z	RW	----	
				Subzone	10 3	1	U8Z8 / DPT_UcountVa lue8_Z	RW	----	
				UI_Tstd	11 1	1	U8 / DPT_Value_1_ Ucount	RW	----	Delay Time since last operation in [sec] This time is fixed for 4min10sec .  The default display will be loaded if no operations on the RU in the period of UI_Tstd.
				Bklight_level	11 4	1	U8 / DPT_Percent_ U8	RW	----	DPT 5.004 --> [0... 255%] with resolution 1% Allow only range [0 ..100%]; U8 / DPT_Percent_U8 is also used by Synco Living Central Apartment Unit for the Backlight Brightness  The brightness of the backlight. (0~100%) --> shift to Extended Device Object, Property 97 (DisplayBacklightValu eOn), since already introduced in Synco living product range? Decision: No, since there's anyway a conflict in assignment of the Property ID (97) in ExtDevObject
				Bklight_Tidl	11 5	1	U8 / DPT_Value_1_ Ucount	RW	----	Delay Time since last operation in [sec]; This time is fixed for 3min30sec .  Backlight's waiting time to turn off when no operations on the RU.
				UI_DefaultPage	11 8	1	N8 / PDT_ENUM8	RW	----	This property decides the default page in a multipage page set.
				Bootloader_ Checksum	12 1	16	PT_UNSIGNED_ CHAR	R	----	Checksum for bootloader upgrade. The checksum algorithm is MD2.
				Bootloader_L ength	12 2	1	U32 / PDT_UNSIGNE D_LONG DPT_Value_4_ Ucount (12.001)	R	----	New bootloader image file length
				FW_BuildNu m	12 3	1	U16 / DPT_Value_2_ Ucount	R	----	Incremental build number for each FW release
				Bootloader_ Version	12 4	1	U5U5U6 / DPT_Version	R	----	Bootloader's version information  M.V.R (U5U5U6). Here M(magic) is not used. V(version).R(Revision) before formal release is 0.1
				EnableSched ulerOperatio n	20 1	1	DPT_Enable	RW	----	[T022.S055- 2D040.001] Property- List of ABI CPC- "RU_B"



				EnableSystemClockSetting	202	1	DPT_Enable	RW	----	[T022.S055-2D040.001] Property-List of ABI CPC-"RU_B"	
				EnableFanBoostOp	203	1	DPT_Enable	RW	----		
				EnableFirePlaceOp	204	1	DPT_Enable	RW	----		
				EnableKitchenHoodOp	205	1	DPT_Enable	RW	----		
				EnableHeatingScreen	206	1	DPT_Enable	RW	----		
				EnableDHWScreen	207	1	DPT_Enable	RW	----		
321	1	13	RTS - Room Temperature Sensor	Interface Object type	1	1	U16 / PDT_UNSIGNIED_INT	R	----		"Room temperature sensor". Read only
				ObjectIndex	29	1	U8 / PDT_UNSIGNIED_CHAR U8 / DPT_Value_1_Ucount	R	Rea.d.ind	needed for Object Index Discovery via LTE-Read onto this Property	=> SD-T060.0601_EN_SARB_Data_Aquisition: 7.1.2.10.1 KNX Standard, chapter 3-5-1, PID_OBJECT_INDEX
				TempRoom	51	1	V16Z8 / DPT_TempHVACAbs_Z	R	IR.req		
				Apartment	101	1	U8Z8 / DPT_UcountValue8_Z	RW	----		
				Room	102	1	U8Z8 / DPT_UcountValue8_Z	RW	----		
				Subzone	103	1	U8Z8 / DPT_UcountValue8_Z	RW	----		
				TempCorrValue	111	1	V16Z8 / DPT_TempHVACRel_Z	RW	----		
				TempCOVCondition	112	1	V16Z8 / DPT_TempHVACRel_Z	RW	----		
				TempRoomHeartbeat	115	1	U16 / DPT_TimePeriodSec	RW	----		Repetition time for cyclic sending of the room temperature process value output, if no COV condition occurs since last sending.
				TempRoomMinRepTime	116	1	U16 / DPT_TimePeriodSec	RW	----		Minimum repetition time for sending of the room temperature process value output.
390	1	14	UHD - User HVAC Display	Interface Object type	1	1	U16 / PDT_UNSIGNIED_INT	R	----		
				ObjectIndex	29	1	U8 /	R	Rea	needed for Object	=> SD-

						PDT_UNSIGNE D_CHAR U8 / DPT_Value_1_ Ucount		d.ind	Index Discovery via LTE-Read onto this Property	T060.0601_EN_SARB _Data_Aquisition: 7.1.2.10.1 KNX Standard, chapter 3-5-1, PID_OBJECT_INDEX	
				TempOutside Eff	15 5	1	V16Z8 / DPT_TempHV ACAbs_Z	R	IR.in d	Outside temperature value provided by the Automation Device (° C) *) Field Description Sup. Unit Default Temperature Outside temperature value M °C. cs STATUS Bitset M Bit 0 - OutOfService Sensor out of service M t/f false Bit 1 - Fault Sensor value is corrupted M t/f false Bit 2 - Overridden Sensor is temporarily overridden O t/f false Bit 3 - InAlarm Sensor is in alarm O t/f false Bit 4 - AlarmUnAck Acknowledgement of alarm O t/f false all other bits are reserved	
				TempRoomE ff	15 7	1	V16Z8/PDT_G ENERIC_03/DP T_TempHVAC Abs_Z	R	IR.in d	Resulting (may be averaged) room temperature value provided by the Automation Device (° C) *)	
				TempRoomS etpAbsEff	16 1	1	V16Z8 / DPT_TempHV ACAbs_Z	R	IR.in d	Absolute Room Temperature Setp requested by the user, calculated from the HVACMode and TempRoomSetpUserO ffset	=> cASA-[T022.S031- 2]-SARB-Data- Mapping-HVAC
				HVACModeE ff	16 3	1	N8Z8 / DPT_HVACMo de_Z	R	IR.in d	Effective HVACMode calculated by the Automation Device based on HVACModeUser request, Scheduler etc.	
				ComfortProlo ngEff	16 8	1	DPT_State	R	IR.in d	information if comfort prolongation is active or not 0=inactive; 1 = active	=> cASA-[T022.S031- 2]-SARB-Data- Mapping-HVAC
				TmpFanMod e	20 8	1	N8 / PDT_ENUM8	R	IR.in d	TmpFanMode refers to the optional process input property of AB UHD to indicate on the Room Unit (e.g. RU-B) if a temporary HRV fan mode is active	Enumeration value - 0: None - 1: FanBoostMode - 2: FirePlaceMode - 3: KitchenHoodMode
				TmpFanMod eRemainTim e	20 9	1	U16 / DPT_TimePerio dSec	R	IR.in d	TmpFanModeRemain Time refers to the optional process input property of AB UHD	=> cASA-[T022.S035- 2]055] Fan operation: Fan Boost/Fire Place/Kitchen Hood

										providing the remaining duration of an activated temporary HRV fan mode. TmpFanModeRemainTime will be zero if no temporary HRV fan mode is active or in case of an activated Kitchen Hood mode which is not automatically terminated by timeout.	
				TempDHWEff	210	1	V16Z8 / DPT_TempHV ACAbs_Z	R	IR.ind	TempDHWEff refers to the process input property of AB UHD to indicate the effective DHW temperature for visualization purposes on PL-Link Room Units. TempDHWEff is calculated by the BA-Device, e.g. an average of upper/lower DHW sensors in the DHW storage tank	
				TempDHWSetpEff	211	1	V16Z8 / DPT_TempHV ACAbs_Z	R	IR.ind	TempDHWSetpEff refers to the process input property of AB UHD to indicate the currently effective DHW temperature setpoint for visualization purposes on PL-Link Room Units.	
				DHWModeEff	213	1	N8Z8	R	IR.ind	DHWModeEff refers to the process input property of AB UHD to indicate the currently effective DHW operating mode for visualization.	
				DelayedHVACModeEff	171	1	N8	R	IR.ind	DelayedHVACModeEff refers to the proprietary and optional process input property to indicate if a manually triggered room operating mode is delayed by an application specific function (e.g. unoccupied selection and delayed HOME (Comfort) -> AWAY (Economy) transition). DelayedHVACModeEff is provided by ABI RSMHD	
				TmpFanModeCountdown	216	1	DPT_State	R	IR.ind	TmpFanModeCountdown refers to the optional and proprietary process input property of AB UHD to differentiate	

										between timed or indefinite fan mode and to indicate the validity of input property TmpFanModeRemain Time. TmpFanModeCountdown is provided by ABI FSSM	
				Apartment	10 1	1	U8Z8 / DPT_UcountValue8_Z	RW	----		
				Room	10 2	1	U8Z8 / DPT_UcountValue8_Z	RW	----		
				Subzone	10 3	1	U8Z8 / DPT_UcountValue8_Z	RW	----		
				OutsideSensorZone	10 4	1	U8Z8 / DPT_UcountValue8_Z	RW	----	Outside sensor zone for TempOutside	
				DHWZone	10 5	1	U8Z8 / DPT_UcountValue8_Z	RW	----	DHWZone refers to the configuration property of AB UHD to define the number of the DHW zone to connect AB UHD with ABIs DHWSM and DHWTS.	
				HVACModeDetermin	21 7	1	DPT_HVACModeDetermin	R	IR.ind	HVACModeDetermin refers to the proprietary and optional process input property to indicate how HVACModeEff is currently determined. HVACModeDetermin is provided by ABI RSMHD	=> [T022.S035-21010.100] Temporary manual HVAC Mode (OEM specific feature) => [T022.S035-21010.110] Manual HVAC Mode via HW contact (OEM specific feature)
1001	1	15	SCLO - System Clock	Interface Object type	1	1	U16 / PDT_UNSIGNIED_INT	R	----		RTC display on the screen
				ObjectIndex	29	1		R	----		
				SystemClock	51	1	U8[r4U4][r3U5][U3U5][r2U6][r2U6]B16 / DPT_DateTime DPT_ID = 19.001	R	IR.ind	Received SystemClock information from Automation Device which is always master SCLO; updated every 10 minutes  Remark: this datapoint is currently defined as S-Mode group objects with a predefined, fixed group address For use on SARB, the BA-Device will send SystemClock with an LTE-InfoReport  Data type definition: 03_07_02 3.20	Time, date and weekday are required to display: Fri, 9, 14:24 6E 01 01 00 00 00 00 00 --> 10.1.1 0:0:0

										This input signal is used by SCLO slave to synchronise its local clock: i.e. SystemClock information is copied to LocalClock.	
				SystemClockSetting	52	1	U8[r4U4][r3U5][U3U5][r2U6][r2U6]B16 / DPT_DateTime DPT_ID = 19.001	R	W.req	SystemClockSetting refers to the process input property of ABI SCLO to write the master clock via a PL-Link peripheral device. • Input SystemClockSetting can be accessed using LTE Write service and broadcast addressing or individual property addressing. • [cASA-4.2-050-N] Implementation of input SystemClockSetting is optional. If implemented, the input shall be activated / deactivated by the engineered configuration parameter EnableSystemClockSetting of ABI SCLO. [end-cASA-4.2-050-N] • [cASA-4.0] This process signal will not be implemented in a 1st step since there is no real use case to adjust date & time information of the BA Device via PL-Link. [end-cASA-4.0]	=> KNX Standard, chapter 7/1/1, FB System Clock, clause Input SystemClockSetting => [T022.S032-2I015] Setting of Local-Date and -Time via Room Unit
391	1	16	UPS - User Presence Switch	Interface Object type	1	1	U16 / PDT_UNSIGNED_INT	R	----		
				ObjectIndex	29	1		R	Read.ind		
				PresenceStatus	51	1	DPT_Occupancy	R	IR.req		
				PresenceStatusLocked	155	1	DPT_Bool	RW	<b>W-ind</b>		
				PresenceStatusEff	201	1	DPT_Occupancy	R	IR.ind		
				Apartment	101	1	U8Z8 / DPT_UcountValue8_Z	RW	----		
				Room	102	1	U8Z8 / DPT_UcountValue8_Z	RW	----		
				Subzone	103	1	U8Z8 / DPT_UcountValue8_Z	RW	----		

393	1	17	UFS - User Fan Speed Setting	Interface Object type	1	1	U16 / PDT_UNSIGNED_INT	R	----	Fan Speed user's setting	
				ObjectIndex	29	1	U8 / PDT_UNSIGNED_CHAR U8 / DPT_Value_1_Ucount	R	Read.ind	needed for Object Index Discovery via LTE-Read onto this Property	=> SD-T060.0601_EN_SARB_Data_Aquisition: 7.1.2.10.1 KNX Standard, chapter 3-5-1, PID_OBJECT_INDEX
				FanBoostReq	162	1	B1 / PDT_BINARY_INFORMATION	R	IR.req	FanBoostReq refers to the optional process output property of AB UFS representing a trigger command requested by the room occupant to initiate the temporary Fan Boost fan mode in HRV applications	=> cASA-[T022.S035-21055] Fan operation: Fan Boost/Fire Place/Kitchen Hood
				FirePlaceReq	163	1	B1 / PDT_BINARY_INFORMATION	R	IR.req	FirePlaceReq refers to the optional process output property of AB UFS representing a trigger command requested by the room occupant to initiate the temporary Fire Place fan mode in HRV applications.	=> cASA-[T022.S035-21055] Fan operation: Fan Boost/Fire Place/Kitchen Hood
				KitchenHoodReq	164	1	B1 / PDT_BINARY_INFORMATION	R	IR.req	KitchenHoodReq refers to the optional process output property of AB UFS representing a trigger command requested by the room occupant to initiate the temporary Kitchen Hood fan mode in HRV applications.	=> cASA-[T022.S035-21055] Fan operation: Fan Boost/Fire Place/Kitchen Hood
				ResetTmpFanReq	165	1	B1 / PDT_BINARY_INFORMATION	R	IR.req	ResetTmpFanReq refers to the optional process output property of AB UFS representing a trigger command requested by the room occupant to cancel an activated temporary fan mode in HRV applications.	=> cASA-[T022.S035-21055] Fan operation: Fan Boost/Fire Place/Kitchen Hood
				FanBoostProlongTime	166	1	U16 / PDT_UNSIGNED_INT	R	IR.req	FanBoostProlongTime refers to the optional process output property of AB UFS to adjust the duration of the temporary Fan Boost ventilation mode in HRV applications.	=> [T022.S035-21058.020] Operation of 'Fan Boost', 'Fire Place' prolong time settings
				FirePlaceProlongTime	167	1	U16 / PDT_UNSIGNED_INT	R	IR.req	FirePlaceProlongTime refers to the optional process output property of AB UFS to adjust the duration of the temporary Fire	=> [T022.S035-21058.020] Operation of 'Fan Boost', 'Fire Place' prolong time settings

										Place ventilation mode in HRV applications.	
				Apartment	10 1	1	U8Z8 / DPT_UcountVa lue8_Z	RW	----		
				Room	10 2	1	U8Z8 / DPT_UcountVa lue8_Z	RW	----		
				Subzone	10 3	1	U8Z8 / DPT_UcountVa lue8_Z	RW	----		
384	1	18	UHRS - User HVAC Room Settings	Interface Object type	1	1	U16 / PDT_UNSIGNE D_INT	R	----		Room temperature set point. User's setting
				ObjectIndex	29	1	U8 / PDT_UNSIGNE D_CHAR U8 / DPT_Value_1_ Ucount	R	Rea d.ind	needed for Object Index Discovery via LTE-Read onto this Property	=> SD- T060.0601_EN_SARB _Data_Aquisition: 7.1.2.10.1 KNX Standard, chapter 3-5-1, PID_OBJECT_INDEX
				TempRoomS etpUserOffse t	52	1	V16Z8 / DPT_TempHV ACRel_Z	R	IR.re q	Setpoint shift (Method A)	
				ComfortProlo ngUser	53	1	B1 / DPT_Trigger	R	IR.re q	Trigger to start an additional period of Comfort Mode 1 = Trigger (0 not used)	
				HVACModeU ser	55	1	N8Z8 / DPT_HVACMo de_Z	R	IR.re q	HVACMode user request: 0 = AUTO 1 = Comfort 2 = Standby (PreComfort) 3 = Economy 4 = Building.Prot.	
				HVACModeU serLocked	15 6	1	B1 / DPT_Bool	RW	W.in d	0: Locked = false; 1: Locked =true	Binary information for locking operation of HVAC Mode; => cASA-[T022.S031- 2]-SARB-Data- Mapping-HVAC
				HVACModeU serEff	15 7	1	N8Z8 / DPT_HVACMo de_Z	R	IR.in d	Result of HVACModeUser and RSMHD internal settings. It is delivered by RSMHD	=> cASA-[T022.S031- 2]-SARB-Data- Mapping-HVAC
				TempRoomS etpUserOffse tMinIN	15 8	1	V16Z8 / DPT_TempHV ACRel_Z	RW	W.in d	Runtime process value for Max. negative Offset of TempRoomSetpUserO ffset	=> cASA-[T022.S031- 2]-SARB-Data- Mapping-HVAC
				TempRoomS etpUserOffse tMaxIN	15 9	1	V16Z8 / DPT_TempHV ACRel_Z	RW	W.in d	Runtime process value for Max. positive Offset of TempRoomSetpUserO ffset	=> cASA-[T022.S031- 2]-SARB-Data- Mapping-HVAC
				TempRoomS etpUserOffse tLocked	16 0	1	B1 / DPT_Bool	RW	W.in d	0: Locked = false; 1: Locked =true	Binary information for locking operation of RoomTemperature Setting;

											'=> cASA-[T022.S031-2]-SARB-Data-Mapping-HVAC
				TempRoomSetpUserOffsetEff	161	1	V16Z8 / DPT_TempHVACRel_Z	R	IR.ind		=> cASA-[T022.S031-2]-SARB-Data-Mapping-HVAC
				StepIncrementHMI_TRSetpUsOffset	171	1	U8 / DPT_Value_1_Ucount	RW	----	This property is a factor value (integer), with which the smallest locally defined step increment (in current units) is multiplied. The result is the StepIncrement on the HMI available to the user	Default Value = 1
				Apartment	101	1	U8Z8 / DPT_UcountValue8_Z	RW	----		
				Room	102	1	U8Z8 / DPT_UcountValue8_Z	RW	----		
	U			Subzone	103	1	U8Z8 / DPT_UcountValue8_Z	RW	----		
				TempRoomSetpUserOffsetMin	113	1	V16Z8 / DPT_TempHVACRel_Z	RW	----	Config value for Max. negative Offset of TempRoomSetpUserOffset	=> cASA-[T022.S031-2]-SARB-Data-Mapping-HVAC
				TempRoomSetpUserOffsetMax	114	1	V16Z8 / DPT_TempHVACRel_Z	RW	----	Config value for Max. positive Offset of TempRoomSetpUserOffset	=> cASA-[T022.S031-2]-SARB-Data-Mapping-HVAC
1003	1	19	ALSNK - Alarm Sink	Interface Object type	1	1	U16 / PDT_UNSIGNED_INT	R	----	ALSNK acts as Alarm Sink in the Room Unit with the purpose to indicate and acknowledge Alarm and Maintenance information (basic Alarm functionality)	
				ObjectIndex	29	1	U8 / PDT_UNSIGNED_CHAR U8 / DPT_Value_1_Ucount	R	----	needed for Object Index Discovery via LTE-Read onto this Property	=> SD-T060.0601_EN_SARB_Data_Aquisition: 7.1.2.10.1 KNX Standard, chapter 3-5-1, PID_OBJECT_INDEX
				AlarmInfo_CS	230	1	PT_GENERIC_13	R	IR.ind	AlarmInfo_CS refers to the process input property of AB ALSNK to indicate Alarm Code and Alarm State information from ABI ALSRC to be visualized on PL-Link Room Units like RU-B	
				MaintenanceInfo_CS	227	1	PT_GENERIC_13	R	IR.ind	MaintenanceInfo_CS refers to the process input property of AB ALSNK to indicate Maintenance Code and Maintenance State information from ABI ALSRC to be	



										visualized on PL-Link Room Units like RU-B	
				AlarmAcknowledge	228	1	PDT_BINARY_INFORMATION / DPT_Ack	R	W.req	AlarmAcknowledge refers to the process output property of AB ALSNK to trigger the acknowledgement of an unacknowledged Alarm indication via PL-Link Room Units like RU-B. AB ALSNK acts as a property client to write input AlarmAcknowledge of the remote ABI ALSRC	
				AlarmReset	229	1	PDT_BINARY_INFORMATION / DPT_Reset	R	W.req	AlarmReset refers to the process output property of AB ALSNK to trigger the reset of the locked state of the BA-Device (caused by an Alarm indication) via PL-Link Room Units like RU-B. AB ALSNK acts as a property client to write input AlarmReset of the remote ABI ALSRC	This feature of AB ALSNK is optional and will not be supported in a 1st step.
				MaintenanceAcknowledge	225	1	PDT_BINARY_INFORMATION / DPT_Ack	R	W.req	MaintenanceAcknowledge refers to the process output property of AB ALSNK to trigger the acknowledgement of an unacknowledged Maintenance indication via PL-Link Room Units like RU-B. AB ALSNK acts as a property client to write input MaintenanceAcknowledge of the remote ABI ALSRC	
				MaintenanceReset	226	1	PDT_BINARY_INFORMATION / DPT_Reset	R	W.req	MaintenanceReset refers to the process output property of AB ALSNK to trigger the reset of the locked state of the BA-Device (caused by an Maintenance indication) via PL-Link Room Units like RU-B. AB ALSNK acts as a property client to write input MaintenanceReset of the remote ABI ALSRC	This feature of AB ALSNK is optional and will not be supported in a 1st step.
337	1	20	RRHS - Room Relative Humidity	Interface Object type	1	1	U16 / PDT_UNSIGNIED_INT	R	----	Local Room Relative Air Humidity Sensor	

			Sensor								
110	1	21	HVACS - HVAC Schedul er	Interface Object type	1	1	U16 / PDT_UNSIGNE D_INT	R	----	HVAC Schedulers	ABI HVACS is a proxy to map and represent the BA-Weekly- Schedule on PL-Link
				ObjectIndex	29	1	U8 / PDT_UNSIGNE D_CHAR U8 / DPT_Value_1_ Ucount				
				HVACSDaily Prog_Mo	23 1	15	DPT_HVACSS witchPoint	R	----	Daily Program Monday	
				HVACSDaily Prog_Tu	23 2	15	DPT_HVACSS witchPoint	R	----	Daily Program Tuesday	
				HVACSDaily Prog_We	23 3	15	DPT_HVACSS witchPoint	R	----	Daily Program Wednesday	
				HVACSDaily Prog_Th	23 4	15	DPT_HVACSS witchPoint	R	----	Daily Program Thursday	
				HVACSDaily Prog_Fr	23 5	15	DPT_HVACSS witchPoint	R	----	Daily Program Friday	
				HVACSDaily Prog_Sa	23 6	15	DPT_HVACSS witchPoint	R	----	Daily Program Saturday	
				HVACSDaily Prog_Su	23 7	15	DPT_HVACSS witchPoint	R	----	Daily Program Sunday	
181	1	22	UDHWS ET - User DHW Settings	Interface Object type	1	1	U16 / PDT_UNSIGNE D_INT	R	----	User DHW Settings	
				ObjectIndex	29	1	U8 / PDT_UNSIGNE D_CHAR U8 / DPT_Value_1_ Ucount	R	Rea d.ind		
				TempDHWS etpUser	52	1	V16Z8 / DPT_TempHV ACAbs_Z	R	IR.re q	TempDHWSetpUser refers to the process output property of AB UDHWSET to adjust the DHW temperature setpoint for DHW 'Normal' mode • Supported Z8-States: OutOfService • Default Value (after powerup) = OutOfService • TempDHWSetpUser must not be sent after a reboot of the Room Unit. Transmission of TempDHWSetpUser may be triggered by user interaction on the HMI only. • Heartbeat: no	=> KNX Standard, chapter 7/11/3, 2.8.4.3 Output TempDHWSetpUser => [T022.S040- 3D015.070] TempDHWSetpUserEf f => [T022.S040- 3D015.080] TempDHWSetpUserMi nIN => [T022.S040- 3D015.090] TempDHWSetpUserM axIN
				DHWPushUs er	53	1	B1 / DPT_Trigger	R	IR.re q	DHWPushUser refers to the process output property of AB UDHWSET to trigger the DHW push function and to load	=> KNX Standard, chapter 7/11/3, clause 2.8.4.4 Output DHWPushUser

										the DWH storage tank once to the 'Normal' temperature setpoint. • Default Value (after powerup) = 0 • DHWPushUser is a trigger signal that must not be sent after a powerup. DHWPushUser may be triggered by user interaction on the HMI only.	
				DHWMoDeU ser	51	1	N8Z8 / DPT_DHWMo de_Z	R	IR.re q	DHWMoDeU refers to the process output property of AB UDHWSET to change the DHW user operating mode via a Room Unit. • Supported Z8-States: OutOfService • Default Value (after powerup) = OutOfService • DHWMoDeU must not be sent after a reboot of the Room Unit. Transmission of DHWMoDeU may be triggered by user interaction on the HMI only. • Heartbeat: no	=> KNX Standard, chapter 7/11/3, clause 2.8.4.2 Output DHWMoDeU
				DHWMoDeU serLocked	15 6	1	B1 / DPT_Boo l	RW	W.in d	DHWMoDeULocked refers to the proprietary input process signal of AB UDHWSET to lock or enable the manual operation of DHWMoDeU on the Room Unit.	
				DHWMoDeU serEff	25 4	1	N8Z8 / DPT_DHWMo de_Z	R	IR.in d	DHWMoDeUEff refers to the process input property of AB UDHWSET to indicate the effective user-request 'Auto' or 'Manual' for the DHW operating mode. • Supported Z8-States: none (for received PL-Link message) • Default Value (after powerup) of local copy of property DHWMoDeUEff = 'void', e.g. with Z8 'OutOfService' => local firmware decision to encode the 'void' state • After a reboot of the Room Unit the local copy of property DHWMoDeUEff remains 'void' until the 1st DHWMoDeUEff message is received.	=> KNX Standard, chapter 7/11/3, clause 2.8.4.7 Input DHWMoDeUEff

										<ul style="list-style-type: none"> <li>Local copy of property DHWModeUserEff becomes valid if the 1st DHWModeUserEff message is received</li> </ul>	
				DHWPushActive	25 2	1	B1 / DPT_Boolean	R	IR.ind	DHWPushActive refers to the process input property of AB UDHWSET to indicate whether the DHW push function is active or not. This information may be used by the Room Unit for visualization	
				TempDHWSetpUserEff	24 6	1	V16Z8 / DPT_TempHV ACAbs_Z	R	IR.ind	<p>TempDHWSetpUserEff refers to the process input property of AB UDHWSET to indicate the effective user defined DHW temperature setpoint for 'Normal' mode</p> <ul style="list-style-type: none"> <li>DWW temperature setpoint editing shall start with the current value of property TempDHWSetpUserEff.</li> <li>After the transmission of process signal TempDHWSetpUser, AB UDHWSET shall immediately update of local copy of TempDHWSetpUserEff with the new setpoint. Later on, updated feedback information TempDHWSetpUserEff will be received from ABI DHWSM within 1..2s to confirm or correct the previous user setpoint settings</li> </ul>	=> [T022.S040-3D015.010] TempDHWSetpUser => [T022.S040-3D015.360] TempDHWSetpUserMin
				TempDHWSetpUserMinN	15 8	1	V16Z8 / DPT_TempHV ACAbs_Z	R/ W	W.ind	TempDHWSetpUserMinN refers to the process input property of AB UDHWSET to define the dynamic lower limit to adjust the DHW temperature setpoint and to define the lower limit of process signal TempDHWSetpUser	=> [T022.S040-3D015.010] TempDHWSetpUser => [T022.S040-3D015.360] TempDHWSetpUserMin
				TempDHWSetpUserMaxN	15 9	1	V16Z8 / DPT_TempHV ACAbs_Z	R/ W	W.ind	TempDHWSetpUserMaxN refers to the process input property of AB UDHWSET to define the dynamic upper limit to adjust the DHW temperature setpoint and to define the upper limit of process signal TempDHWSetpUser	=> [T022.S040-3D015.010] TempDHWSetpUser => [T022.S040-3D015.370] TempDHWSetpUserMax

				TempDHWSetpUserLocked	160	1	B1 / DPT_Bool	R/W	W.ind	TempDHWSetpUserLocked refers to the proprietary input process signal of AB UDHWSET to lock or enable the manual adjustment of TempDHWSetpUser on the Room Unit.	
				TempDHWSetpUserMin	161	1	V16Z8 / DPT_TempHV ACAbs_Z	R/W	----	TempDHWSetpUserMin refers to the configuration property of AB UDHWSET to define the static outer lower limit to edit the setpoint TempDHWSetpUserMin • TempDHWSetpUserMin may be used to initialize TempDHWSetpUser • TempDHWSetpUserMin shall be used to initialize TempDHWSetpUserMinIN	=> [T022.S040-3D015.070] TempDHWSetpUserEff => [T022.S040-3D015.080] TempDHWSetpUserMinIN
				TempDHWSetpUserMax	162	1	V16Z8 / DPT_TempHV ACAbs_Z	R/W	----	TempDHWSetpUserMax refers to the configuration property of AB UDHWSET to define the static outer upper limit to edit the setpoint TempDHWSetpUserMax • TempDHWSetpUserMax shall be used to initialize TempDHWSetpUserMaxIN	=> [T022.S040-3D015.090] TempDHWSetpUserMaxIN
				DHWZone_Controller	101	1	U8Z8 /DPT_UcountValue8_Z	R/W	----	DHWZone refers to the KNX standardized configuration property to define the number of the DHW zone to connect ABI DHWSM with ABs USHWSET and UHD. • Supported Z8-States: OutOfService • Supported-Z8-Commands: NormalWrite, SetOSV & ResetOSV • Default value = 1	=> KNX Standard, chapter 7/11/3, clause 2.2.4.14 Parameter: DHWZone_Controller => [T022.S037-2I010.015] Attaching ABI DHWSM to the BA-Model => [T022.S037-2I020.010] Attaching ABI DHWSM to the BA-Model

Issued by  
Siemens Switzerland Ltd  
Smart Infrastructure  
Global Headquarters  
Theilerstrasse 1a  
CH-6300 Zug  
+41 58 724 2424  
[www.siemens.com/buildingtechnologies](http://www.siemens.com/buildingtechnologies)