

REMOTE CONTROLLER (WIRED TYPE)

INSTALLATION MANUAL



PART No. 9373328650-01

Type RVRV/RVRG/RVRX

For authorized service personnel only.

Installation by endusers or not qualified persons can cause harm to personal safety, can cause severe damage to building and product, can lead to improper function or reduced lifetime of the equipment.

CONTENTS

1. SAFETY PRECAUTIONS.....	1
2. MAIN UNIT AND ACCESSORIES.....	2
3. ELECTRICAL REQUIREMENT.....	2
4. SELECTING AN INSTALLATION LOCATION.....	2
5. INSTALLING THE REMOTE CONTROLLER.....	2
6. SETTING THE REMOTE CONTROLLER.....	5
7. TEST RUN.....	12
8. ERROR CODES.....	12

1. SAFETY PRECAUTIONS

1.1. Safety precautions

- The "SAFETY PRECAUTIONS" indicated in the manual contain important information pertaining to your safety. Be sure to observe them.
- For details of the operation method, refer to the operation manual.
- Request the user to keep the manual on hand for future use, such as for relocating or repairing the unit.

WARNING

Indicates a potentially or imminently hazardous situation which, if not avoided, could result in death or serious injury.

Installation of this product must be done by experienced service technicians or professional installers only in accordance with this manual. Installation by nonprofessional or improper installation of the product may cause serious accidents such as injury, water leakage, electric shock, or fire. If the product is installed in disregard of the instructions in this manual, it will void the manufacturer's warranty.

Installation must be performed in accordance with regulations, codes, or standards for electrical wiring and equipment in each country, region, or the installing place.

Do not operate this unit when your hands are wet. Touching the unit with wet hands will cause an electric shock.

When children can approach the unit or touch the unit, take preventive measures.

Dispose of the packing materials safely. Tear and dispose of the plastic packing bags so that children cannot play with them. There is the danger of suffocation if children play with the original plastic bags.

CAUTION

Indicates a potentially hazardous situation that may result in minor or moderate injury or damage to property.

When detecting the room temperature using the remote controller, set up the remote controller according to the following conditions. If the remote controller is not well set, the correct room temperature will not be detected, and thus the abnormal conditions like "not cool" or "not heat" will occur even if the air-conditioner is running normally. :

- A location with an average temperature for the room being air conditioned.
- Locate where is not be affected by inflow of outside air such as caused by opening and closing a door.
- Not directly exposed to the outlet air from the air conditioner.
- Out of direct sunlight.
- Away from the influence of other heat sources.

Do not install the unit in the following areas:

- Do not install the unit near a source of heat, steam, or flammable gas. Otherwise, fire could result.
- Area filled with mineral oil or containing a large amount of splashed oil or steam, such as a kitchen. It will deteriorate plastic parts, causing the parts to fall.
- Area containing equipment that generates electromagnetic interference. It will cause the control system to malfunction, and cause erroneous operation.
- Install the unit in a well-ventilated place avoiding rains and direct sunlight.
- Do not touch the touch screen area with pointed objects, otherwise it may cause electric shock or malfunction.
- To avoid injury due to shards of broken glass, do not apply excessive force to the touch screen area.

Do not expose this unit directly to water. Doing so will cause trouble, electric shock, or heating.

Do not set vessels containing a liquid on this unit. Doing so will cause heating, fire, or electric shock.

1.2. Radio Wave Usage Precautions

CAUTION

Changes or modifications not expressly approved by the party responsible for compliance could void the user's authority to operate the equipment.

This transmitter must not be co-located or operated in conjunction with any other antenna or transmitter.

This equipment complies with FCC/IC radiation exposure limits set forth for an uncontrolled environment and meets the FCC radio frequency (RF) Exposure Guidelines and RSS-102 of the IC radio frequency (RF) Exposure rules. This equipment should be installed and operated keeping the radiator at least 20 cm or more away from a person's body. (UTY-RVRU model conforms to IC (Industry Canada) standard.)

NOTES

This device complies with Part 15 of FCC Rules and Industry Canada license-exempt RSS standard(s).

Operation is subject to the following two conditions:

- (1) this device may not cause harmful interference, and
 - (2) this device must accept any interference received, including interference that may cause undesired operation.
- (UTY-RVRU model conforms to IC (Industry Canada) standard.)

This equipment has been tested and found to comply with the limits for a Class B digital device, pursuant to part 15 of the FCC Rules.

- Do not use this product in the following locations. Using this product in such locations may cause communications to become unstable or not possible.
 - Near wireless communication equipment that uses the same frequency band (2.4 GHz) as this product.
 - Places where there are magnetic fields from equipment such as microwave ovens, or static electricity or radio wave interference occurs. (Radio waves may not reach depending on the environment.)
- The Bluetooth® word mark and logos are registered trademarks owned by Bluetooth SIG, Inc. and any use of such marks by FUJITSU GENERAL LIMITED is under license. Other trademarks and trade names are those of their respective owners.
- Specifications
 - BLE standard: BLE4.2
 - Frequency bands: 2.4GHz
 - Maximum radio-frequency power: 7mW

English

Deutsch

Français

Español

Italiano





Ελληνικά

Portugués

Türkçe

2. MAIN UNIT AND ACCESSORIES

The following installation parts are supplied. Use them as required.

Name and shape	Qty	Name and shape	Qty
 Wired remote controller	1	 Self-tapping screw (M4 × 16mm) For installing the remote controller	2
 Installation manual (This manual)	1	 Cable tie For binding remote controller and remote controller cable	1
 Operation manual	1		

3. ELECTRICAL REQUIREMENT

When connecting the remote controller use the following wiring.

Cable size	Wire type	Remarks
0.75 to 1.25 mm ² (18 to 16 AWG)	Non polar 2 core	Use sheathed twisted pair cable

Select a flexible cable that can be bound using cable ties from over the cable sheath inside this unit.

	VRF	PAC/RAC
Max. connectable number of remote controllers	2	1
Total cable length	Max. 70 m (229 ft)	

4. SELECTING AN INSTALLATION LOCATION

4.1. Dimensions and Name of parts

Remote controller unit

Unit: mm (in)

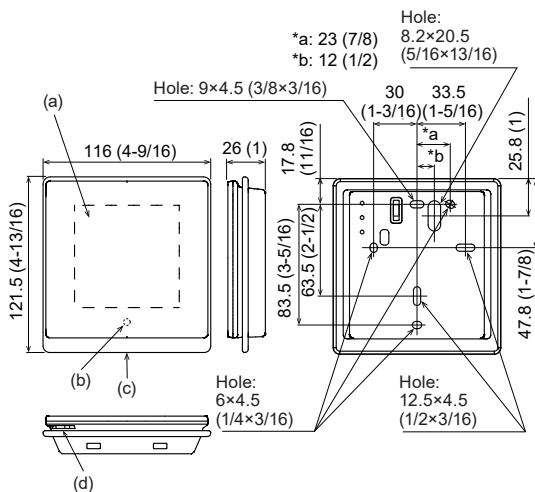

- Touch screen
- Ambient light sensor (inside)
- Operation lamp
- Room temperature sensor (inside)

4.2. Setting the room temperature detection location

⚠ CAUTION

As the temperature sensor of remote controller detects the temperature near the wall, when there is a certain difference between the room temperature and the wall temperature, the sensor will not detect the room temperature correctly sometimes. Especially when the outer side of the wall on which the sensor is positioned is exposed to the open air, it is recommended to use the temperature sensor of the indoor unit to detect the room temperature when the indoor and outdoor temperature difference is significant.

The detection location of the room temperature can be selected from the following 2 methods. Choose the detection location that is best for the installation location. The temperature sensor of the indoor unit or the remote controller can be used to detect the room temperature.

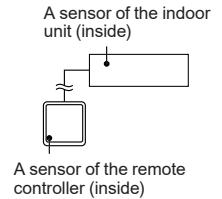

When the temperature sensor of remote controller is not used, the following functions cannot be used.

- [Custom Auto] of the operation modes: Refer to operation manual.
- [Optimum start]: Refer to operation manual.

4.3. Installation space

- Do not embed this remote controller in a wall.
- Even when you install a remote controller to one of a switch box and the surface of a wall, secure the space shown in following figure. When there is insufficient space, there may be remote controller sensor misdetections and remote controller removal may be difficult.

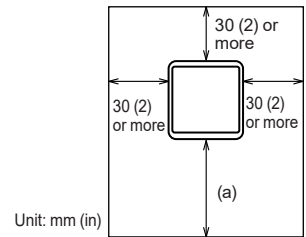

- Secure enough space where a flat-blade screwdriver, etc. to take off a case can be inserted.

5. INSTALLING THE REMOTE CONTROLLER

⚠ WARNING

Always use the accessories and specified installation work parts. Check the state of the installation parts. Not using the specified parts will cause units to fall off, water leakage, electric shock, fire, etc.

Install at a place that can withstand the weight of the unit and install firmly so that the unit will not topple or fall.

When installing this unit, make sure that there are no children nearby. Otherwise, injury or electric shock could result.

Before starting installation work, shut off the equipment to which this unit is connected. Do not supply power until installation work is completed. Otherwise, it will cause electric shock or fire.

Use the accessories or specified connection cables. Do not modify connection cables other than those specified, do not use extension cords, and do not use independent branch wiring. The allowable current will be exceeded and cause electric shock or fire.

Install the remote controller cables securely to the terminal block. Confirm that external force is not applied to the cable. Use remote controller cables made of the specified wire. If intermediate connection or insertion fixing are imperfect, it will cause electric shock, fire, etc.

When connecting the remote controller cable, route the cables so that the rear case of this unit is securely fixed. If the rear case is imperfectly fixed, it may cause fire or overheating of the terminals.

Always fasten the outside covering of the connection cable with the cable tie. If the insulator is chafed, electric discharge may occur.

CAUTION

- Before opening the case of this unit, completely discharge static electricity charged on you body. Not doing so will cause trouble.
- Do not touch the circuit board and circuit board parts directly with your hands. Otherwise, injury or electric shock could result.
- Be careful so that the front case does not fall after the front case screws are removed. Otherwise, injury could result.
- Install the remote controller cables 1 m away from television and radio to avoid distorted images and noise.
- Confirm the name of each terminal block of the unit and connect the wiring in accordance with the directions given in the manual. Improper wiring work will damage the electric parts and cause smoke and fire.
- Connect the connectors securely. Loose connectors will cause trouble, heating, fire, or electric shock.
- Never bundle the remote controller cables, the power supply cable and transmission cable together. Bundling these cables together will cause miss operation.
- When installing the connection cable near a source of electromagnetic waves, use shielded cable. Otherwise, a breakdown or malfunction could result.

5.1. Wiring types

5.1.1. Single control

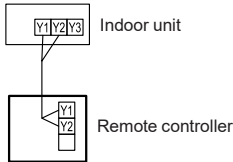

5.1.2. Group control

With a single remote controller, up to 16 units can be simultaneously operated.

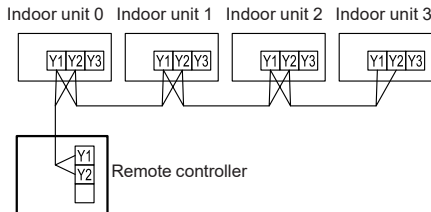

5.1.3. Multiple remote control

Number of connectable remote controllers. VRF: 2, RAC/PAC: 1

Multiple installation method described above is prohibited to combine 3 Wired type with 2 Wired Type.
 In multiple installations, the following functions are restricted.
 Functions that can only be used with a Primary Remote Controller:

- Auto Off Timer Setting *1
- Weekly Timer Setting *1
- Set Temp. Auto Return *1
- Optimum Start Setting *1
- IU Address Verification
- Function Setting

(*1 : Refer to operation manual)

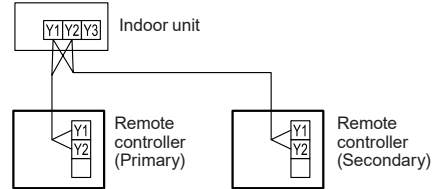

Group control and multiple remote control can be used together.

NOTE:

There are some restrictions when 3-wire remote controller and 2-wire remote controller are connected to the same group. For details, refer to the operation manual of this remote controller.

5.2. Preparing for Installation

5.2.1. Strip of the remote controller cable

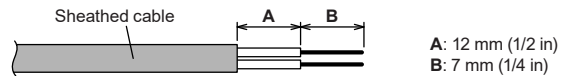

5.2.2. Remove the front case

- (1) Insert the flat-bladed screw driver, etc. to the hole of bottom surface and lightly lift the front case.
- (2) Disconnect the connection cable connector from the connector of the front case PC board (printed circuit board).

NOTES:

- When opening the remote controller, remove the connector from the front case. The cables may break if the connector is not removed and the front case hangs down.
- When installing the front case, connect the connector to the front case.
- When removing and connecting the connector, be careful not to break the cables.
- To avoid damage to the remote controller body, work on a soft cloth, etc.
- Be careful not to scratch the remote controller body with a flat-blade screwdriver, etc.

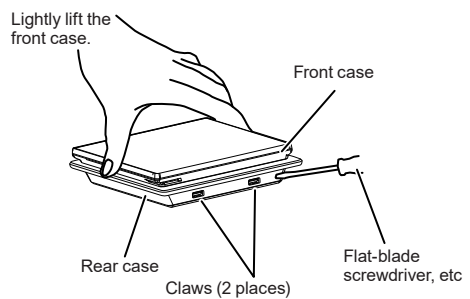

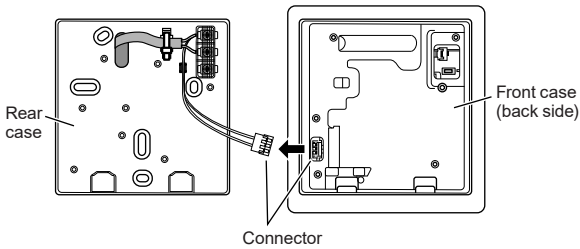

5.2.3. Setting the switch

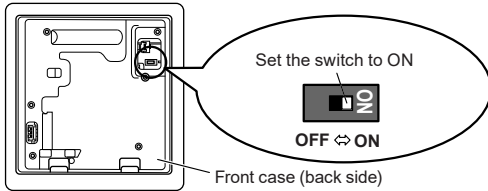

Before using this product, always set switch to "ON". If not set, when the main power is turned on again, the set data by menu operation will be erased and cause erroneous operation.

[Switch]

- Performs the enabling/disabling of the backup function by the internal battery.
- It is disabled when shipped from the factory to prevent consumption of the charge.

5.3. Installation

CAUTION

Perform wiring so that water does not enter this unit along the external wiring. Always install a trap to the wiring or take other countermeasures. Otherwise it will cause trouble or electric shock or fire.

5.3.1. Install the rear case

A. When attaching to switch box:

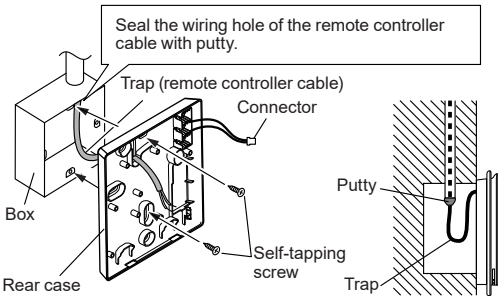

B. When attaching to the wall directly:

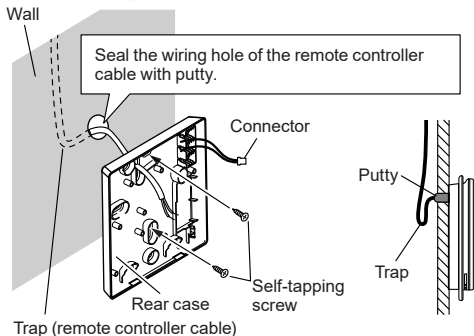

C. When routing the cable on-wall:

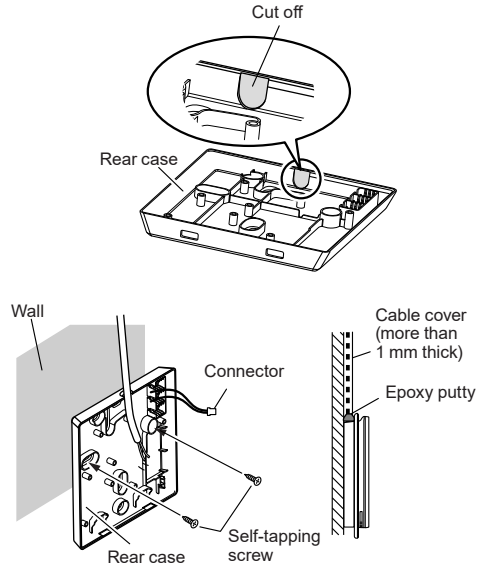

5.3.2. Connecting the remote controller cable

CAUTION

When connecting a remote controller cable to the remote controller terminal block, use the specified torque to tighten screws. If you over-tighten screws, they will break the terminal unit.

Be careful to avoid breaking the cable by over-tightening the cable tie.

Tightening torque	0.8 to 1.2 N·m (7.1 to 10.6 lbf·in)
-------------------	-------------------------------------

Fasten the outside covering of the connection cable with the cable tie. Tighten the cable tie firmly so that pulling force does not propagate to the terminal connection even if force of 30 N is applied to the cable.

Select a flexible cable that can be bound using cable ties from over the cable sheath inside this unit.

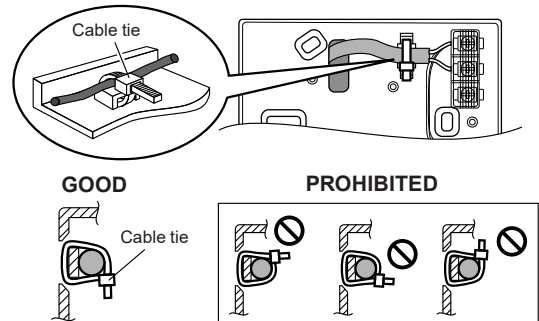

5.3.3. Attach the front case

- (1) When the cable is disconnected from the clamp, attach the cable to the clamp.
- (2) Connect the remote controller cable connector to the connector of the front case PC board.

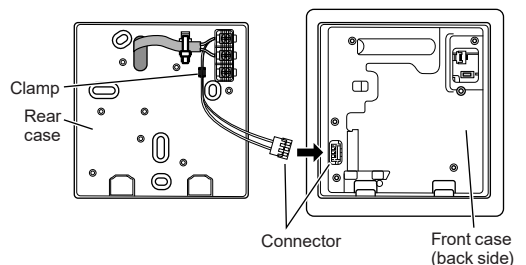

- (3) Hook the upper part of the front case to the upper part of the rear case.
- (4) Push the lower part of the front case and fit the claw on the bottom surface.

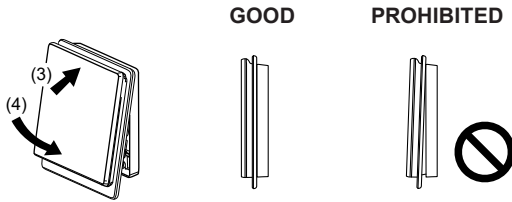

NOTES:

- When fitting the claw on the bottom surface of front case, be careful not to get cables caught in the front case.
- Check that there is no gap between the front and rear cases and the claws on the bottom surface can be seen through the hole.
- If it is difficult to check for gap or claws, pull the lower part of the front case toward you to check that front and rear cases are fitted securely.

5.4. Connecting to the indoor unit

CAUTION

When connecting the remote controller cable to the indoor unit, do not connect it to the outdoor unit or the power terminal block. It may cause a failure.

When switching the DIP switch (SW1) on the indoor unit PC board, be sure to turn off the power supply to the indoor unit. Otherwise, the PC board of the indoor unit may be damaged.

There are 2 methods to connect the remote controller cable to the indoor unit. One is the connection using connecting cable (Included in the indoor unit), and the other is the connection the remote controller cable is connected to the exclusive terminal block of the indoor unit.
(For the details, refer to the installation manual of the indoor unit to be used.)

5.4.1. When connecting to the connector

- (1) Use a tool to cut off the terminal on the end of the remote controller cable, and then remove the insulation from the cut end of the cable as shown in Fig. 1. Connect the remote controller cable and connecting cable as shown in Fig. 2. Be sure to insulate the connection between the cables.

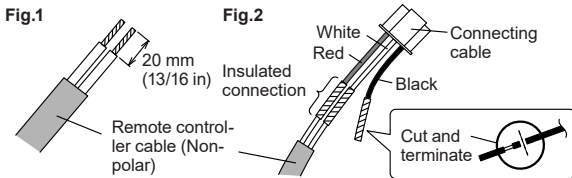

- (2) Connect the remote controller cable to the connecting cable, and insert it to the connector. Set to "2WIRE" the DIP switch (SW1) on the PC board of the indoor unit.

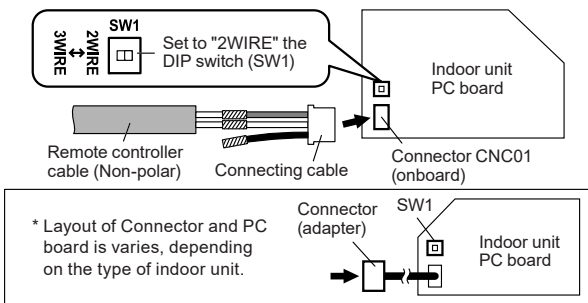

5.4.2. When connecting to exclusive terminal block

- (1) Connect the end of remote controller cable directly to the exclusive terminal block. Set to "2WIRE" the DIP switch (SW1) on the PCB (printed circuit board) of the indoor unit.

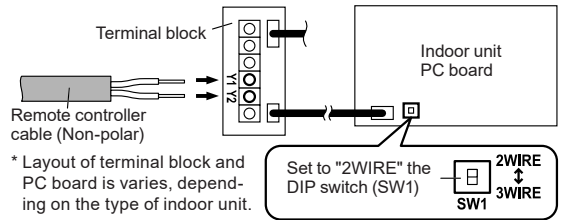

Tightening torque	
M3 screw (Remote controller / Y1, Y2)	0.5 to 0.6 N·m (4.4 to 5.3 lbf-in)

For "Group control" or "Multiple remote control", refer to the following figure on how to connect to the indoor unit terminal.

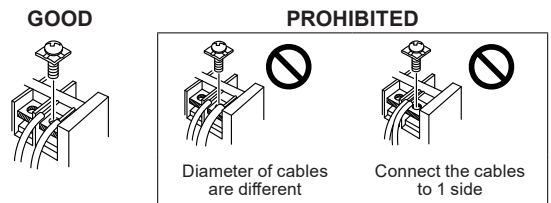

6. SETTING THE REMOTE CONTROLLER

6.1. Basic operation

1. Display the main screen. The main screen has 3 basic operation screens and 1 other setting screen.
2. The "Other Setting" screen is displayed by horizontal swiping operation.

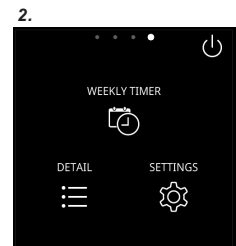
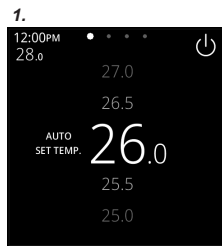

3. Tap [SETTINGS]. The "Settings" screen is displayed.
- 4-1. Tap [Initial Setting]. The "Initial Setting" screen is displayed.

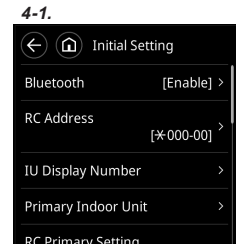
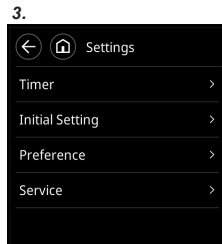

4-2. Tap [Preference]. The "Preference" screen is displayed.

4-3. Tap [Service]. The "Service" screen is displayed.

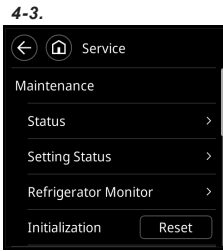
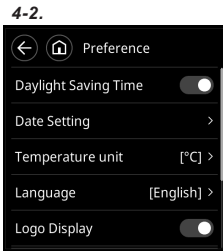

(Items that indoor unit does not support are not displayed.)

For details on operation, refer to the operation manual.

■ Passwords

When a password is requested, enter the installer password.

This unit has two kinds of passwords; password for administrators and password for installers. Password for administrators cannot be used for the settings related to the installation of this unit. Installer password can be used to configure all of setting for this unit.

When "Password (Installer Password) Verification" screen is displayed, enter the password (installer password) and tap [OK]. The default password is "0000" (4 digits).

Password display/non-display switching icon

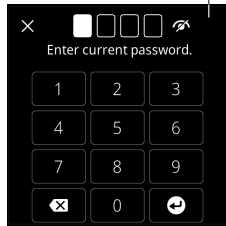

6.2. Initialization procedure

After remote controller installation work is complete, perform initialization using the following procedures before starting to use the system. (Items that indoor unit does not support are not displayed.)

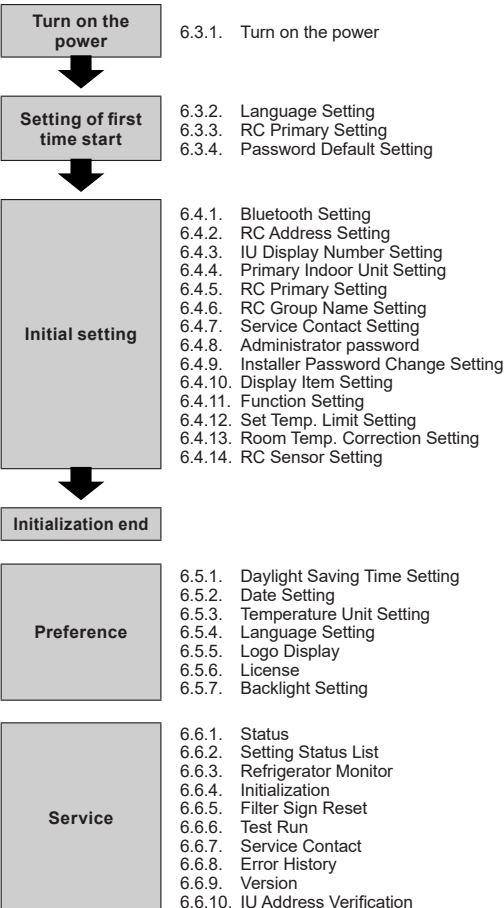

After installing this unit, perform the test run to confirm that the unit is operating properly. Then, explain the operation of this unit to the customer.

6.3. Setting of first time start

6.3.1. Turn on the power

CAUTION

Recheck the wiring. Incorrect wiring will cause trouble.

When initially starting up this unit, the following setting screen will be displayed. Settings configured at this stage can be changed afterwards.

If an error screen is displayed, shut down all unit power, and check the connections. After resolving the problem, turn on the power again.

Wired remote controller system start-up error
Error (Code:12.4)

If "Address duplication in wired remote control system" is displayed, tap [Close], and the "RC Address Setting" screen (refer to 6.4.2) will be displayed. After setting, restart this unit.

Address duplication in wired remote controller system
Error (Code:26.4)

Close

6.3.2. Language Setting

- Select and tap the language to be used. When setting is complete, the "RC Primary Setting" screen is displayed.

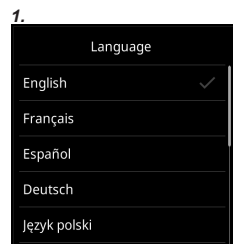

6.3.3. RC Primary Setting

- If the remote controller is a single connection, this setting is omitted.
 - If a remote controller has multiple connections, and if "Primary" is initially set, all other units will be set to "Secondary".
- Tap [Next]. The "Password Default Setting" screen is displayed.

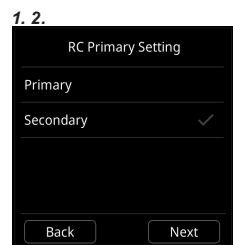

Set only one Primary remote controller. Units other than Primary are set to Secondary automatically. When remote controllers are set to "Secondary", setting items will be restricted.

6.3.4. Password Default Setting

- Select and tap [Commercial] or [Residential] and tap [Next]. The initial value at "Change Setting" of "Password Setting" is different depending on the selection of commercial use or residential use. Refer to the table below.

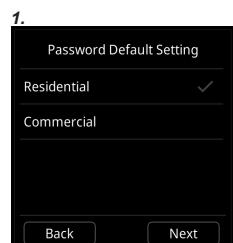

Function (*: Items that indoor unit does not support are not displayed.)	Commercial	Residential
Weekly Timer	On	Off
Settings	On	Off
Economy	On	Off
Occupancy Sensor Setting	On	Off
Fan Control for Energy Saving	On	Off
Set Temp.Return	On	Off
Anti-Freeze *	On	Off
Emergency Heat	On	Off
Filter sign	On	Off

- When initial start-up setting is complete, the screen on the right will be displayed. This screen is the main screen, which is the home screen of this unit.

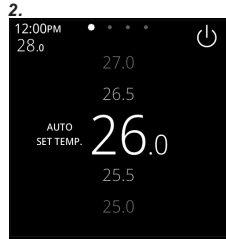

6.4. Initial setting

6.4.1. Bluetooth Setting

- Tap [Bluetooth] on the "Initial Setting" screen. The "Bluetooth" screen is displayed.
- When this unit and smartphone are connected, tap [Start] on "Pairing" field. When "Connect" appears on "Status" field, the connection is complete.
- When the setting works are finished by smartphone, tap [Stop] to stop the output of radio waves. "Off" is displayed on "Status" field.
- Tap [←] to return to the "Initial Setting" screen.



NOTE:

For details on operation, refer to the operation manual of smartphone application.

Status of Bluetooth communication

Status	Description
Off	Radio waves of Bluetooth communication are not output.
Connect	Bluetooth communication between this unit and a smartphone is connected.
Disconnect	Bluetooth communication between this unit and a smartphone is disconnected. Radio waves are always output to reconnect to the already paired smartphone.

- This screen allows the user to view the information necessary to connect a smartphone and this unit via Bluetooth.
- The "Device Name" and "Bluetooth Address" can be checked.
- If a logo image sent from a smartphone is stored, the logo image will be displayed for a few seconds by tapping the [Preview] button in "Logo" field.

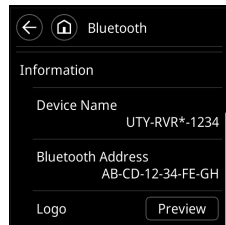

NOTE: To make a Bluetooth connection

- Requirement:
 - You have a smartphone on which the "AIRSTAGE Remo Set" app is installed and running.
 - Your smartphone supports Bluetooth version 4.2 or later.
- Open the "AIRSTAGE Remo Set" app and follow the instructions from there.

6.4.2. RC Address Setting

- Remote controller address can be set automatically. Addresses will be automatically set when initially starting up this unit.
- When an administrator wants to manage the remote controller address of the indoor unit, it is necessary to perform "Manual Address Setting" described below.

[Setting the remote controller address at the side of the indoor unit]

- If the address is set automatically, set the remote controller address of the indoor unit to "0". Please do not change this setting.
- For how to configure the remote controller addresses for the indoor unit, refer to its installation manual.

■Checking the remote controller address

- Tap [RC Address] on the "Initial Setting" screen. The "RC Address" screen is displayed. The "Current Address" is displayed as [System-Unit]. The value for "Unit" refers to the remote controller address. Tap [←] to return to the "Initial Setting" screen.

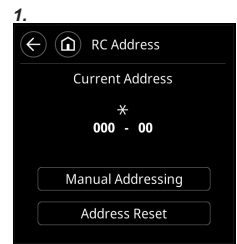

When the address is set manually, this mark * is displayed. [001-01]

■Manual Address Setting

Remote controller address can be manually set to any number.

[Setting the remote controller address at the side of the indoor unit]

- A remote controller address for the indoor unit needs to be set.
- Set the remote controller addresses for the indoor units which are connected using the same remote controller cable with a range from 1 to 9 and from A (10) to F (15), without any duplicates. (Do not use "0" for configuration.)
- For how to configure the remote controller addresses for the indoor unit, refer to its installation manual.

- Tap [RC Address] on the "Initial Setting" screen. The "RC Address" screen is displayed. Tap [Manual Addressing].
- Tap the address number to set the address of this unit. Tap [←] to return to the "Initial Setting" screen. If you wish to carry out configuration again, tap [Address Reset] on the "RC Address" screen.

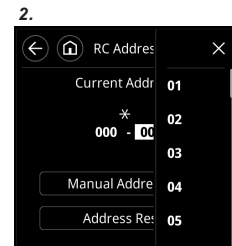
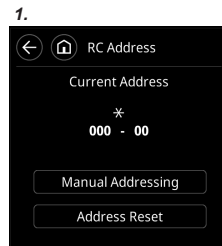

The address for this unit can be set from 1 to 32. However, do not set the same number as that for the remote controller address of an indoor unit connected using the same remote controller cable.

6.4.3. IU Display Number Setting

At initial starting, the display numbers (Unit X) of the indoor units displayed at the "Individual Hold" setting of this remote controller are automatically allocated in ascending order of address value. For the indoor unit display number (Unit X), refer to "Individual Hold" of the operation manual. The indoor units (corresponding addresses) can be rearranged in arbitrary order in which you want to correspond to the display number (Unit X) at this setting. Decide the indoor unit (address) corresponding to the display number (Unit X) by consulting the user.

1. Tap [IU Display Number] on the "Initial Setting" screen.
2. "IU Display Number" screen is displayed. The address (System-Unit) allocated to the current display number (Unit X) is displayed. The refrigeration system address (Ref.-in.) is displayed only when this remote controller is connected to a VRF system. Tap the display numbers (Unit X) whose address you want to interchange.
3. Select and tap the address of the indoor unit you want to match to the display number selected at step 2 with Δ or ∇ . The address is interchanged with the selected display number (Unit X). Repeat steps 2 and 3 up to the desired order. Tap [\leftarrow] to return to the "Initial Setting" screen.

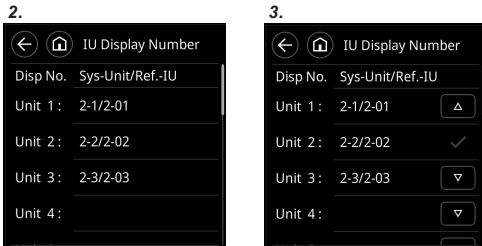

6.4.4. Primary Indoor Unit Setting

- One of the multiple indoor units connected to the same refrigerant system or RB unit can be set as the "primary unit".
- The indoor unit defined as the "primary unit" determines the priority mode (cool or heat) within the refrigerant system or RB group.
- Switch setting on the outdoor unit or RB unit that is connected to the indoor units. Refer to the installation manual of outdoor unit or RB unit.

1. Tap [Primary Indoor Unit] on the "Initial Setting" screen. The "Primary Indoor Unit" screen is displayed. To set a unit as the Primary Indoor Unit, tap [Set].
2. Tap [\leftarrow] to return to the "Initial Setting" screen.



When changing the Primary Indoor Unit, another indoor unit cannot be made the primary indoor unit unless the settings of the current primary indoor unit are cancelled beforehand. ("Reset" cannot be performed while the indoor unit is operating.)

6.4.5. RC Primary Setting

If multiple remote controllers are set for a remote control group or for a single indoor unit, it is necessary to set the remote controller primary. This setting will be required at the time of initial start-up during installation. However, this setting can be changed afterwards. No primary remote controllers will be automatically set to be secondary. The following functions can be used with secondary remote controllers.

1. Tap [RC Primary Setting] on the "Initial Setting" screen. The "RC Primary Setting" screen is displayed.
2. Select and tap the setting to be used.

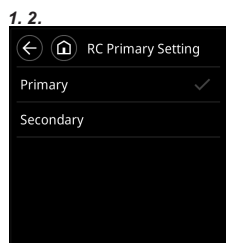

Do not perform this setting during setting or operating from the Primary unit.

6.4.6. RC Group Name Setting

1. Tap [RC Group Name] on the "Initial Setting" screen. The "RC Group Name" screen is displayed.
2. Tap the relevant key and enter a name. Tap [\leftarrow] to return to the "Initial Setting" screen.

1. 2.

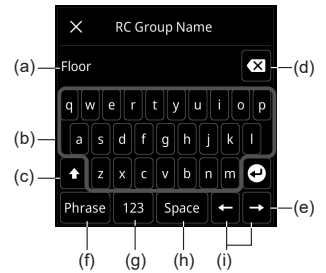

- (a) Input area: The maximum number of characters to be entered is 12.
- (b) Character keys
- (c) Shift key
- (d) Backspace key
- (e) Enter key
- (f) Phrase key: Floor, Corridor, Office, Conf Room, Receipt Room, Room, Room No., Front, Side, Entrance, Outlet, East, West, South, North, Window are registered. Tap [Phrase] until the phase you wish to use appears. When [Phrase] is tapped, the phrase that have been displayed so far disappears.
- (g) Enter mode switching key
- (h) Space key
- (i) Cursor keys

6.4.7. Service Contact Setting

Register the name, phone, and E-mail address of service technician.

1. Tap [Service Contact] on the "Initial Setting" screen.
2. Tap [Name] to enter the name. Name: Maximum 50 characters
3. Tap [Phone] to enter the phone number. Phone: Maximum 20 characters
4. Tap [E-mail address] to enter the E-mail address. E-mail address: Maximum 50 characters
5. Tap [\leftarrow] to return to the "Initial Setting" screen.

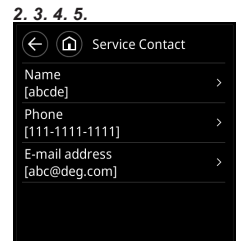

6.4.8. Administrator password

■ Change Password

Set or change the administrator password.

1. Tap [Admin Password] on the "Initial Setting" screen. The "Password Setting" screen is displayed. Then tap [Change Password] on the "Password Setting" screen.
2. Enter the administrator password, then tap [\leftarrow]. The default password is "0000" (4 digits).
3. Enter the new password, then tap [\leftarrow]. It returns to the "Password Setting" screen.

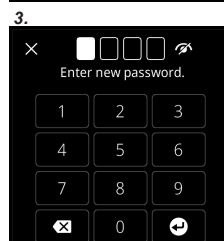
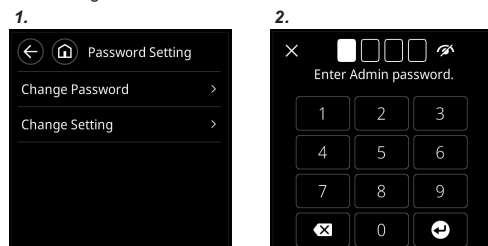

■ Change Setting

Before operating the following items, set whether the password entry screen is displayed or not.

Setting items: Weekly timer, Setting, Economy, Occupancy Sensor, Energy Saving Fan, Set Temp. Auto Return, Anti Freeze, Emergency Heat, Filter Sign Reset

1. Tap [Change Setting] on the "Password Setting" screen. The "Password Setting" screen is displayed.

Items that indoor unit does not support are not displayed.

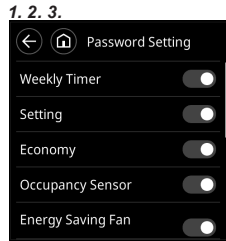

2. Tap the toggle buttons of the appropriate items to set whether the items are displayed or not.
3. Tap [←] to return to the "Password Setting" screen. And then, tap [←] to return to the "Initial Setting" screen.

6.4.9. Installer Password Change Setting

Change the Installer password.

1. Tap [Change Installer Password] on the "Initial Setting" screen. The "Enter Installer Password" screen is displayed. Enter the installer password, then tap [OK]. The default password is "0000" (4 digits).
2. The "Enter New Password" screen is displayed. Enter the new password, then tap [OK]. It returns to the "Initial Setting" screen.

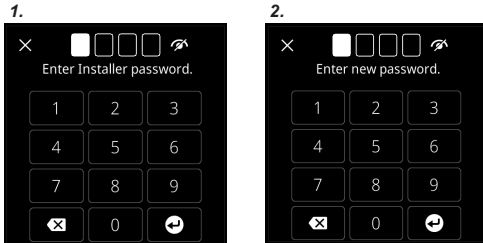

6.4.10. Display Item Setting

Set whether or not the setting items of "Room Temp.," "Filter Sign," "On/Off," "Mode," "Fan Speed" and "Air Flow Direction" are displayed on the menu screen.

1. Tap [Display Item] on the "Initial Setting" screen. The "Display Item" screen is displayed.
2. Tap the toggle buttons of items you want to display on the menu screen to set whether the items are displayed or not.
3. Tap [←] to return to the "Initial Setting" screen.

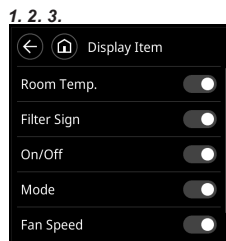

6.4.11. Function Setting

This procedure changes the function settings used to control the indoor unit according to the installation conditions. Incorrect settings can cause the indoor unit to malfunction. Perform the "Function Setting" according to the installation conditions using the remote controller.

• Refer to the indoor unit installation manual for details on the function numbers and setting numbers, before the start of function setting.

1. Tap [Function Setting] on the "Initial Setting" screen. The "Function Setting" screen is displayed.
2. Tap the numerical part of "Address" to select and tap the indoor unit address to be set. Tap [x]. (To set all indoor units at the same time, tap [All].)
3. Tap the numerical part of "Function No." to select and tap the function number. Tap [x].
4. Tap the numerical part of "Setting No." to select and tap the setting number. Tap [x].

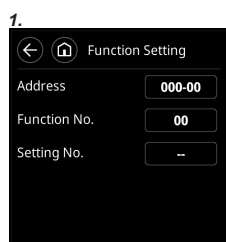

5. Tap [Set].

6. Tap [←] to return to the "Initial Setting" screen.

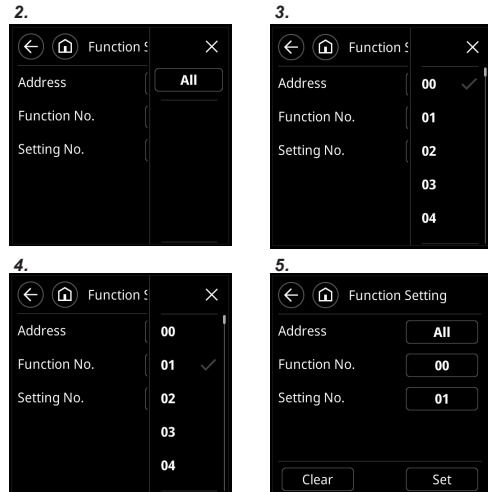

6.4.12. Set Temp. Limit Setting

1. Tap the toggle button of "Set Temp. Limit" field on the "Initial Setting" screen to make the setting enabled.
2. Tap [Set Temp. Limit] on the "Initial Setting" screen. The "Set Temp. Limit" screen is displayed.
3. Tap [Cool/Dry] on the "Set Temp. Limit" screen. The "Limit of Cool/Dry" screen is displayed. Set "Upper Limit" and "Lower Limit". Tap [OK] to return to the "Set Temp. Limit" screen.
4. Tap [Heat] on the "Set Temp. Limit" screen. The "Limit of Heat" screen is displayed. Set "Upper Limit" and "Lower Limit". Tap [OK] to return to the "Set Temp. Limit" screen.
5. Tap [←] to return to the "Initial Setting" screen.

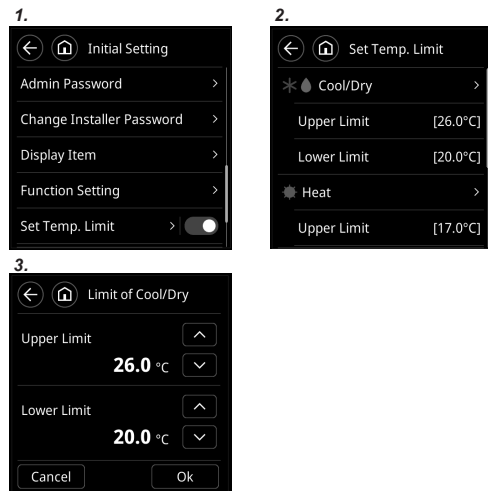

6.4.13. Room Temp. Correction Setting

- Uniformly corrects detection variations in the wired remote controller's temperature sensor.
- Uniformly corrects differences between the actual temperature and the temperature detected by the wired remote controller.

NOTES:

The following situations where uniform correction is not possible are not covered under the warranty for room temperature correction.

- ① If a measurement variation between the temperature detected by the temperature sensor and the actual temperature around the wired remote controller occurs due to the effects of direct sunlight
- ② If a measurement variation between the temperature detected by

the temperature sensor and the actual temperature around the wired remote controller occurs due to the effects of the wall temperature

③ If a difference occurs between the temperature detected by the temperature sensor and the temperature in and around the center of the room due to the effects of air currents

1. Tap [Home] button for 5 seconds or more on the "Initial Setting" screen. The "Room Temp. Correction" screen is displayed. Set the correction temperature by tapping \wedge or \vee . The correction temperature can be set from -4.0°C to +4.0°C in 0.5°C increments.
2. Tap [←] to return to the "Initial Setting" screen.

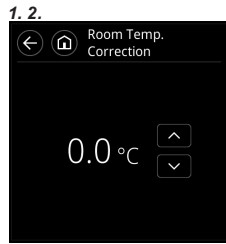

■Date Format Setting

9. Tap [Date Format] on the "Date Setting" screen. The "Date Format" screen is displayed.
10. Select and tap the date display format. Tap [←] to return to the "Date Setting" screen.

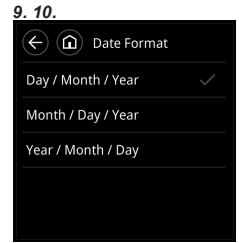

■Time Format Setting

11. Tap [Time Format] on the "Date Setting" screen. The "Time Format" screen is displayed
12. Select and tap the time display format. Tap [←] to return to the "Date Setting" screen.

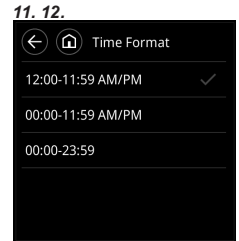

6.4.14. RC Sensor Setting

1. Tap the toggle button of "RC Sensor Setting" field on the "Initial Setting" screen to set whether RC Sensor is used or not.



When RC Sensor Setting is disabled, the following functions cannot be used: (Refer to the operation manual.)

- Custom Auto in the operation mode
- Optimum Start Setting

6.5. Preference

6.5.1. Daylight Saving Time Setting

Switch between Enabled or Disabled for Daylight saving time.

1. Tap the toggle button of "Daylight Saving Time" field on the "Preference" screen to set whether the item is enabled or not.

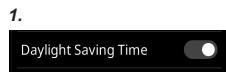

6.5.3. Temperature Unit Setting

Set the unit of temperature.

1. Tap [Temperature unit] on the "Preference" screen. The "Temperature unit" screen is displayed.
2. Select and tap [°F] or [°C].
3. Tap [←] to return to the "Preference" screen.

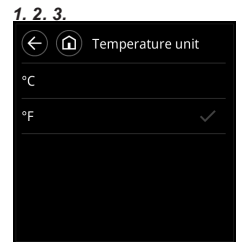

6.5.2. Date Setting

Set "Date", "Time", "Date Format", and "Time Format".

1. Tap [Date Setting] on the "Preference" screen. The "Date Setting" screen is displayed. Select and tap "Date", "Time", "Date Format", or "Time Format".
2. When settings for all items are complete, tap [←] to return to the "Preference" screen.

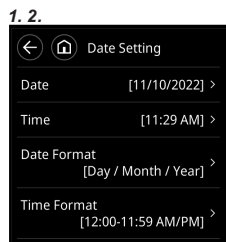

6.5.4. Language Setting

Set the language to be displayed.

1. Tap [Language] on the "Preference" screen. The "Language" screen is displayed.
2. Select and tap the language to be used.
3. Tap [←] to return to the "Preference" screen.

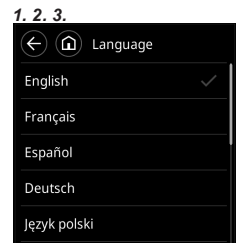

■Date Setting

1. Tap [Date] on the "Date Setting" screen. The "Date" screen is displayed.
2. Tap the numerical part of "Day" and then set the day.
3. Set "Month" and "Year" in the same way.
4. Set all required items, and tap [OK] to return to the "Date Setting" screen.

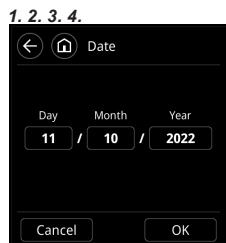

6.5.5. Logo Display

Set whether the logo sent from smartphone is displayed or not.

1. Tap the toggle button of "Logo Display" field on the "Preference" screen to set whether the logo is displayed or not.



NOTE:

When you want to display the logo image on the standby screen, set "Time After Lighting" to "Dimming" in "6.5.7. Backlight Setting".

6.5.6. License

Display the information of License.

1. Tap [License] on the "Preference" screen. The "License" screen is displayed.
2. The information of License can be checked.
3. Tap [←] to return to the "Preference" screen.

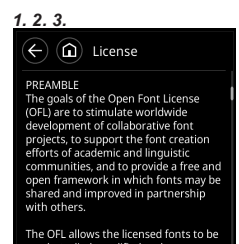

■Time Setting

5. Tap [Time] on the "Date Setting" screen. The "Time" screen is displayed.
6. Tap the numerical part of "Hour" and then set the hour.
7. Set "Minute" and "AM/PM" in the same way.
8. Set all required items, and tap [OK] to return to the "Date Setting" screen.

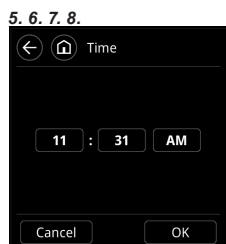

6.5.7. Backlight Setting

1. Tap [Backlight] on the "Preference" screen. The "Backlight Setting" screen is displayed. Select and tap the "Brightness Sensor Control", "Brightness", "Time After Lighting", or "Automatic Off Time".
2. When settings for all items are complete, tap [←] to return to the "Preference" screen.

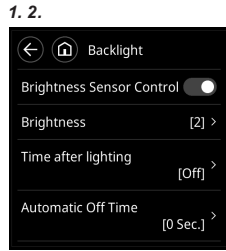

■ Brightness Sensor Control setting

Automatically adjusts the brightness of the screen according to the brightness of the room.

1. Tap the toggle button of "Brightness Sensor Control" field on the "Backlight" screen to set whether the ambient light sensor is used or not.
2. Tap [←] to return to the "Preference" screen.



Status	Description
Enable	The backlight is controlled according to the ambient brightness detected by the ambient light sensor on this controller.
Disable	Conforms to the "Brightness" setting.

■ Brightness setting

Set the brightness of backlight.

1. Tap [Brightness] on the "Backlight" screen. The "Brightness" screen is displayed.
2. Select and tap [1: Dark], [2: Normal], or [3: Bright].
3. Tap [←] to return to the "Backlight" screen.

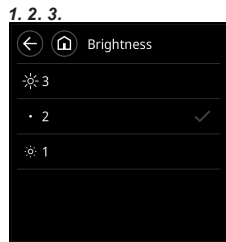

■ Time After Lighting

Select whether to turn off or dim the backlight after operating this remote controller

1. Tap [Time After Lighting] on the "Backlight" screen. The "Time After Lighting" screen is displayed.
2. Select and tap [OFF] or [Dimming].
3. Tap [←] to return to the "Backlight" screen.

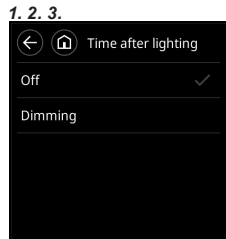

Status	Description
Off	After the time set in "Automatic Off Time" has passed, the backlight will turn off. (The operation lamp lights up while the air conditioner is operating.)
Dimming	After the time set in "Automatic Off Time" has passed, the brightness of the backlight will be reduced and one of the following will be displayed: <ul style="list-style-type: none"> • When "Logo Display" setting is enabled, the registered image is displayed. (Only if an image was registered during installation.) • When "Logo Display" setting is off, the "Standby mode" screen is displayed.

NOTE:

To prevent screen burn-in, it turns off once every 30 minutes.

■ Automatic Off Time

Set the time until the backlight turns off automatically when operation has not been performed for a certain period of time.

1. Tap [Automatic Off Time] on the "Backlight" screen. The "Automatic Off Time" screen is displayed.
2. Select and tap [120 sec.], [90 sec.], [60 sec.], or [30 sec.].
3. Tap [←] to return to the "Backlight" screen.

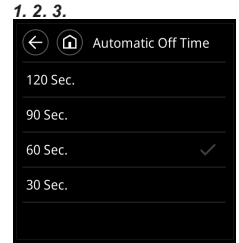

6.6. Service

6.6.1. Status

The operation status of indoor unit can be checked.

1. Tap [Status] in the "Maintenance" field on the "Service" screen. The "Status" screen is displayed.
2. Tap [←] to return to the "Service" screen.

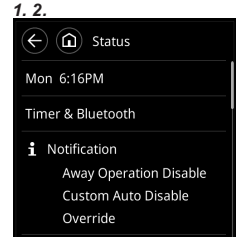

6.6.2. Setting Status List

The setting status of remote controller can be checked.

1. Tap [Setting Status] in the "Maintenance" field on the "Service" screen. The "Setting Status" screen is displayed.
2. Tap [←] to return to the "Service" screen.

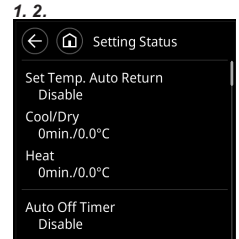

6.6.3. Refrigerator Monitor

1. Tap [Refrigerator Monitor] in the "Maintenance" field on the "Service" screen. The "Refrigerator Monitor" screen is displayed. Select and Tap the address of indoor unit which you want to monitor.
2. The category which you want to monitor is displayed.

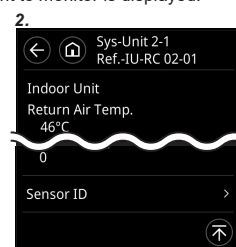
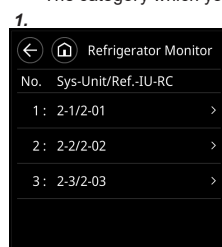

3. If you select [Sensor ID], input the ID of the monitoring item.
4. Information on the selected category is displayed.
5. Tap [←] to return to the previous screen. And tap [←] to return to the "Service" screen.

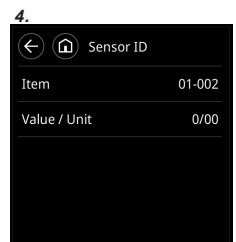
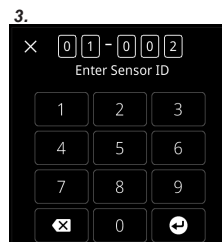

6.6.4. Initialization

Reset all setting items to factory defaults. Require an Installer password.

1. Tap [Reset] of "Initialization" field on the "Service" screen. Enter the Installer password. The initialization screen is displayed.
2. Tap [OK] to restart automatically after initialization, and perform each setting.

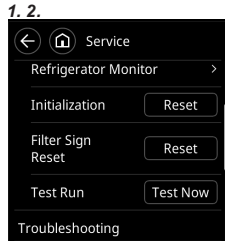

When relocating the set remote controller, initialize it.

6.6.5. Filter Sign Reset

Require an Installer password.

1. Tap [Reset] of "Filter Sign Reset" field on the "Service" screen. Enter the Installer password. The filter sign reset screen is displayed.
2. Tap [OK] to reset the filter sign, and return to the "Service" screen.

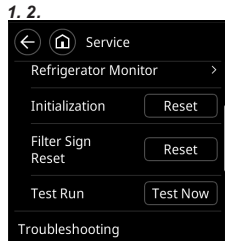

6.6.6. Test Run

Carry out a test run after completing configuration.

1. Tap [Test Now] of "Test run" field on the "Service" screen. The "Test Run" screen is displayed. Tap [OK] and start the test run. The test run will automatically end in approximately 60 min.

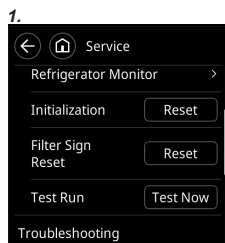

End of test run

- If test run starts while operation is off, press the power button twice to end the test run.
- If test run starts while operation is on, press the power button once to end the test run.
- In any case, when the circle display on main screen is not yellow, the test run is ended.

6.6.7. Service Contact

The contents entered in "6.4.7. Service Contact Setting" is displayed.

6.6.8. Error History

1. Tap [Error History] in the "Troubleshooting" field on the "Service" screen. Up to a maximum of 32 errors can be saved. Once there are more than 32 errors, the oldest one will be deleted. Tap [←] to return to the "Service" screen.
2. To delete the error history, tap [Erase All] and then [OK] on the confirmation screen.

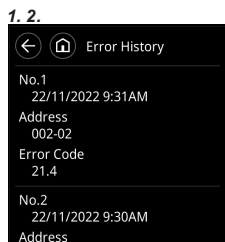

6.6.9. Version

The software version of this controller is displayed.



6.6.10. IU Address Verification

Check the address and position of the indoor unit.

1. Tap [IU Address Verification] in the "Troubleshooting" field on the "Service" screen. The "IU Address Verification" screen is displayed.
2. Tap the address of indoor unit to start checking process. The selected indoor unit will start to blow air and flash a LED*. (*Only when the indoor unit has the relevant functions)
3. Tap [←] to stop the checking progress and return to the "Service" screen.



7. TEST RUN

• Refer to the indoor unit installation manual.

For how to carry out a test run, refer to "6.6.6. Test Run".

8. ERROR CODES

Check the error

1. If an error occurs, an error icon "△" appears on main screen. Tap "△" on main screen. The "Error Information" screen is displayed.
2. Top 2-digit numbers correspond to the error code in the table below.

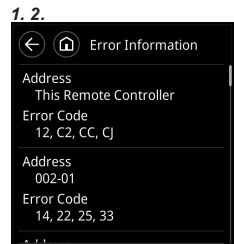

For the details of the indoor unit or outdoor unit error, refer to the error codes in each installation manual.

Error code	Contents
CC.1	Sensor error
CJ.1	Other parts(BLE module) error
C2.1	Transmission PCB error
12.1	Wired remote controller communication error
12.3	Number excess of device in wired remote controller system
12.4	Wired remote controller system start-up error
26.4	Address duplication in wired remote controller system
26.5	Address setting error in wired remote controller system
15.4	Data acquisition error