

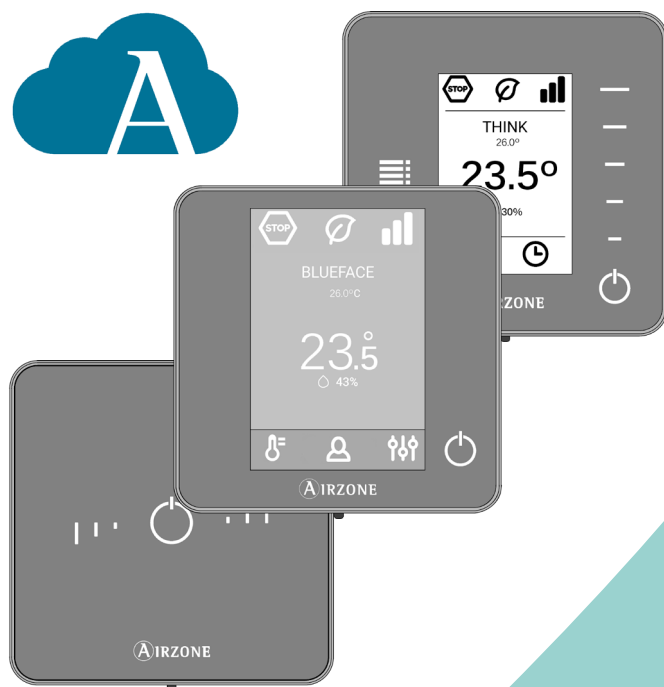

EN

Installation Manual

Flexa 3.0



 AIRZONE

A	Azul	Blue	Azul	Bleu	Bleu	Blaü
-	Negro	Black	Negro	Noir	Nero	Schwarz
B	Verde	Green	Verde	Vert	Verde	Schwarzer Kabelschirm
+	Rojo	Red	Vermelho	Rouge	Rosso	Grün
						Rot

N	Neutro	Neutral	Neutro	Neutre	Neutro	Neutraleiter
L	Fase	Phase	Fase	Phase	Fase	Phase
⏚	Tierra	Ground	Terra	Terra	Terra	Schutzleiter

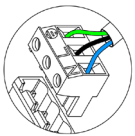
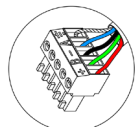
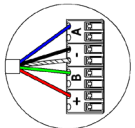
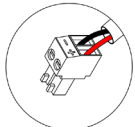

1

3

4

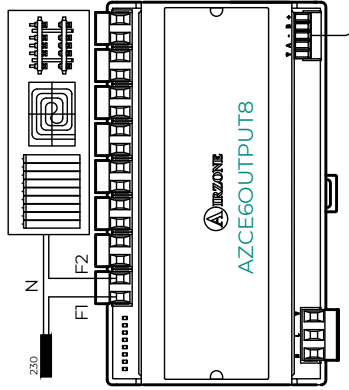

AZCE6BLUEZERO

AZCE6LITEC

AZCE6THINKR

AZCE6LITER

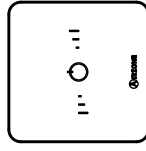
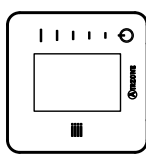
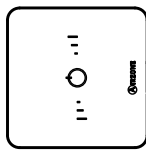
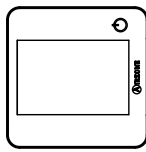

3

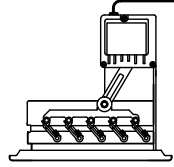
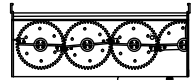
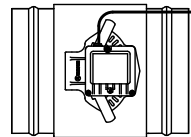
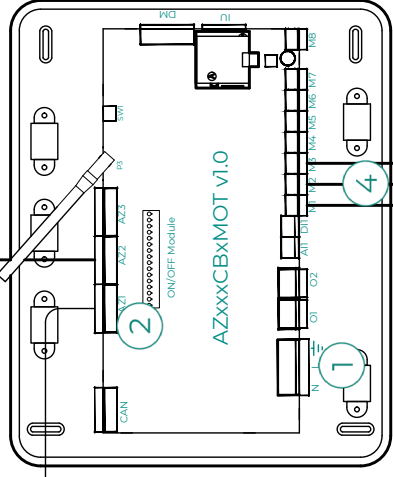

CPCC

CPRC

RINT

4

Index

ENVIRONMENTAL POLICY	3
BEFORE STARTING	7
ELEMENTS AND INSTALLATION	8
> Main control board (AZCE8CB1MOT)	8
> Assembly	8
> Connection	8
> Temperature probe (AZX6SONDPROTEC)	12
> Control Module of Radiant Elements (AZCE6OUTPUT8)	13
> Assembly	13
> Connection	13
> Wired Thermostat	15
> Elements	15
> Assembly	15
> Connection	15
> Wireless thermostats	16
> Elements	16
> Assembly	16
> Airzone Control Gateway-3 Speed Fancoil (AZX6FANCOILZ)	17
> Elements	17
> Assembly	17
> Connection	18
> Airzone Control Gateway-0-10 V Fancoil (AZX6010VOLTSZ)	19
> Elements	19
> Assembly	19
> Connection	20
> Airzone Control Gateway-Electromechanical Unit (AZX6ELECTROMECH)	21
> Elements	21
> Assembly	21
> Connection	22
> Webserver Airzone Cloud	24
> Elements	24
> Assembly	25
> Connection	26
> Supermaster Controller (AZX6CMASTER [S/E] [B/G])	28
> Assembly	28
> Connection	28
> Production control board	29

> Elements	29
> Assembly	29
> Connection	30
> Airzone-KNX Integration Gateway (AZX6KNXGTWAY)	34
> Elements	34
> Assembly	34
> Connection	34
> Airzone Consumption Meter (AZX6ACCCON)	35
> Assembly	35
> Connection	35
> Reset	35
SYSTEM INSTALLATION	36
> Control board Installation	36
> Thermostat installation	36
> Connecting the motorized elements	37
> Connection to the indoor unit	37
> Communications gateway option	37
> Control gateway option	37
> O1 port option	37
> Other peripherals	38
> Power supply to the system	38
CHECKING THE INSTALLATION	39
INITIAL CONFIGURATION	40
> Airzone Blueface zero	40
> Airzone Think	41
> Airzone Lite	43
> Checking the initial configuration	44
> System reset	44
> Zone reset	44
SYSTEM ADVANCED SETTINGS	45
> Airzone Blueface zero	45
> Airzone Think	45
> Airzone Cloud	45
> System parameters	46
> Zone parameters	49
INCIDENTS	50
> Warnings	50
> Errors	50
NAVIGATION TREES	60
> Airzone Blueface zero	60

> Screensaver	60
> Main screen	60
> Advanced settings	61
> Screensaver	61
> Main screen	61
> Airzone Think	62
> Screensaver	62
> Main screen	62
> Advanced settings	63
> Screensaver	63
> Main screen	63

Environmental policy

EN



- Never dispose of this equipment with household waste. Electrical and electronic products contain substances that can be harmful to the environment if not properly handled. The crossed-out waste bin symbol indicates separate collection of electrical devices, which must be separated from other urban waste. For correct environmental management, at the end of its useful life the equipment should be taken to the collection centers provided for this purpose.
- The parts that make it up can be recycled. Therefore, please respect the regulations in force regarding environmental protection.
- If you replace the equipment, the original equipment must be returned to your dealer or deposited at a specialized collection center.
- Violations are subject to the penalties and measures stipulated in environmental protection law.

Before Starting



- The system must be installed by a qualified technician.
- This product must not be modified or disassembled under any circumstances.
- Do not handle the system with wet or damp hands.
- In the case of any malfunction of this appliance, do not repair it yourself. Contact the sales distributor or service dealer for repair or disposal of the product.



- Check that the HVAC installation has been installed according to the manufacturer's requirements, complies with local regulations in force and is working correctly before you install the Airzone system.
- Place and connect the elements in your installation in accordance with current regulations covering electrical installations.



- All connections must be made with the power supply completely turned off.
- Take care not to short circuit any of the system's connections.
- Please refer carefully to the wiring diagram and these instructions when wiring.
- Connect all wiring securely. Loose wiring may cause overheating at the connection points and is a possible fire hazard.
- Do not locate the Airzone communication bus close to power lines, fluorescent lights, actuators, etc. as this may cause interference in communications.
- The connection to the external power supply must include a main switch or other method of disconnection that includes a constant separation for all polarities, in accordance with appropriate local and national regulations. The system will



automatically restart if the power supply is turned off. **Use separate circuits for the unit that is to be controlled and the power supply to the system.**

- Check the polarity of each device's connectors. A wrong connection can seriously damage the product.
- To connect to the system, use Airzone cable: four-wire cable (2x0.22 mm² twisted shielded wires for data communications and 2x0.5 mm² wires for power supply).
- A Blueface zero thermostat must be used to enable all the Airzone system functionalities.
- Recommendations for the placing of the thermostats:



- For equipment using R32 refrigerant, verify the compliance with the local refrigerant regulation.
- The room size installation requirements mentioned in the manual of the ducted indoor unit, to which the Easyzone is connected, remain applicable to each and every separate room served by the Airzone unit.
- Ducts connected to Easyzone shall not contain a potential ignition source.

Elements and Installation

EN

MAIN CONTROL BOARD (AZCE8CB1MOT)

For further information, see the [technical fact sheet](#).

Assembly

The system's main control board is delivered in a screwed box for surface mounting. The location and installation of this element must comply with the current electronic regulations.

1. Locate the main control board close to the AC unit to be controlled.
2. Unscrew the cover to fix the rear part to the wall.
3. Once all connections have been made, screw the cover back on.

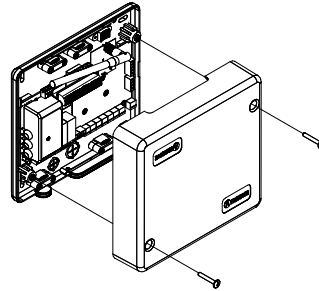

Connection

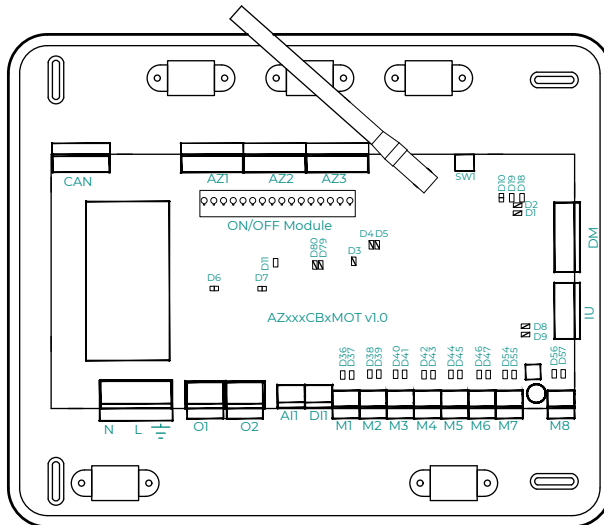

Important: If you have an Easyzone EZ8 system, you have the option of incorporating a zone On/Off control module (AZCE6ACCOFF) on the main control board.

For further information on the On/Off module, see the [technical fact sheet](#).

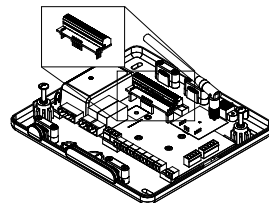

AZ1 - AZ2 - AZ3

The Airzone connection bus is used to connect all the internal elements independent of the main control board and can control up to 8 zones.

To connect the Airzone connection bus, there are three 5-pin terminals. This system allows star and bus connection. Use 2x0.5 + 2x0.22 mm² Airzone cable. Fix the cables with the screws on the terminal, following the color code.

Important: For elements with external power supply at 110/230 VAC, it is only necessary to connect poles "A" and "B" of the bus for communications.

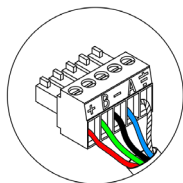

- A Blue
- Black
- B Green
- + Red
- Shield

For increased safety, fix the cables to the main control board using the turrets:

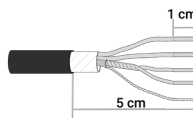
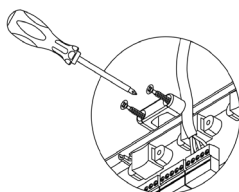

SW1

The system main control board has wireless communication for connecting wireless Airzone elements. These devices are associated by opening the association channel on the main control board. To do this, press SW1 until LED D19 turns red. For 15 minutes, the system will keep the wireless association channel open.

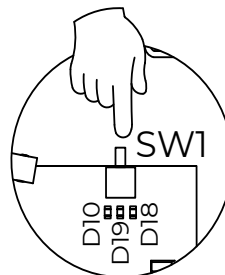

DMI

The automation bus allows several systems to be interconnected in order to manage all of them, using the control peripherals offered by Airzone or their integration into a higher-level control network.

To connect the automation bus, there is one 5-pin terminal. This system only uses bus connections. Fix the cables with the screws on the terminal, following the color code.

Important: For elements with external power supply at 110/230 VAC, it is only necessary to connect poles "A", "B" and "Shield" of the communications bus. Only use the shield on the connector on the main control board side.

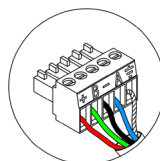

- A Blue
- Black
- B Green
- + Red
- Shield

IU

The AC unit bus makes it possible to connect various control gateways (AZX6GTC/AZQ6QADAPT/AZX6010VOLTSZ/AZX6FANCOILZ/AZX6ELECTROMECH) to the installed AC unit.

To connect the AC unit bus, there is one 4-pin terminal. The connection of these elements is point to point. Fix the cables with the screws on the terminal, following the color code.

Important: For elements with external power supply at 110/230 VAC, it is only necessary to connect poles "A", "B" and "Shield" of the communications bus. Only use the shield on the connector on the main control board side.

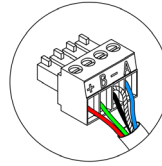

A	Blue
-	Black Shield
B	Green
+	Red

To connect integrated gateways, disconnect the AC unit bus terminal and fit the connector and the gateway fixing post.

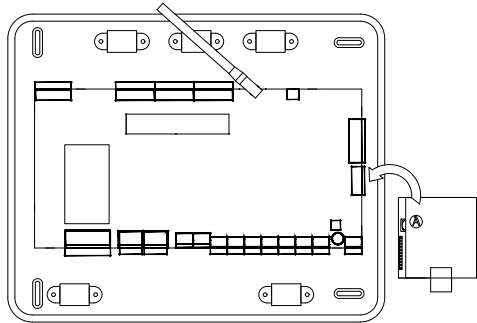

M1...M8

The 12 V outputs enable connecting the Airzone motorized elements in each zone so that they can be managed through the system's main control board, maximum 8 motorizations per control board, up to 2 motorizations per output.

For connecting the actuator outputs, it has eight 2-pin terminals. Fix the cables with the screws on the terminal, following the color code.

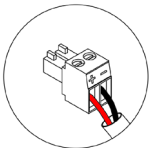

+	Red
-	Black

DII

This input sets the Stop mode on the AC unit, closing all system dampers when an alarm warning is received and blocking the operation mode. This input is configured as normally closed. For proper system operation, this contact is shipped with a bridge from the factory.

AII

Allows the return temperature of an AC unit to be measured by means of an external probe. The use of this probe is recommended when working with electromechanical or NON Inverter units, where the return temperature of the AC unit must be controlled.

O2

This output can be configured for the control of controlled mechanical ventilation units (CMV) or for the management of a boiler (see Advanced settings section on the Blueface zero thermostat - System parameters).

- CMV configuration

Status	Stop	Ventilation	Cooling	Air heating	Radiant heating
Demand ON	OFF	ON	ON	ON	ON
Demand OFF	OFF	ON	ON	ON	ON

- Boiler configuration

Status	Stop	Ventilation	Cooling	Air heating	Radiant heating
Demand ON	OFF	OFF	OFF	OFF	ON
Demand OFF	OFF	OFF	OFF	OFF	OFF

The technical characteristics of the CMV/Boiler relays are I_{max} 1 A at 24-48 V voltage free. To control higher power elements, the use of contactors of the power to be controlled is recommended.

O1

This output is designed for the Stop-Start of AC units, in the event that only this type of control is required. The operation logic of this output is as follows:

Status	Stop	Ventilation	Cooling	Air heating	Radiant heating
Demand ON	OFF	ON	ON	ON	OFF
Demand OFF	OFF	OFF	OFF	OFF	OFF

The technical characteristics of the Stop-Start relays are I_{max} 1 A at 24-48 V voltage free. To control higher power elements, the use of contactors of the power to be controlled is recommended.

N L

This connector supplies power to the system main control board and consequently to the elements connected to it. External power supply at 110/230 VAC.

The power connection to the module is via a 3-pin terminal. Fix the cables with the screws on the terminal, following the color code.

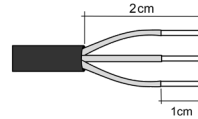
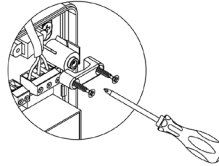
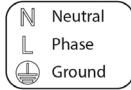
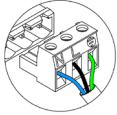

The connection to the external power supply must include a main switch or other method of disconnection that includes a constant separation for all polarities, in accordance with appropriate local and national regulations. The system will automatically restart if the power supply is turned off. **Use separate circuits for the unit that is to be controlled and the power supply to the system.**

Once all the connections have been made, make sure the cover of the main control board is correctly replaced.

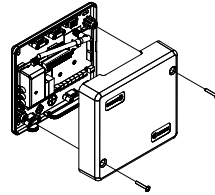

TEMPERATURE PROBE (AZX65ONDPROTEC)

For further information, see the [technical fact sheet](#).

Connects to the temperature probe (All) connector. Protects the AC unit from the water returning to the boiler.

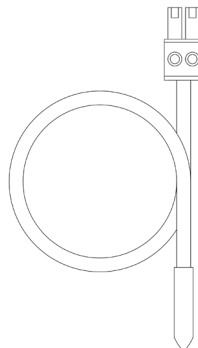

CONTROL MODULE OF RADIANT ELEMENTS (AZCE6OUTPUT8)

For further information, see the [technical fact sheet](#).

Assembly

This device is DIN rail mounted. This module is externally powered at 110/230 VAC. The location and assembly of this module must comply with current electronic regulations.

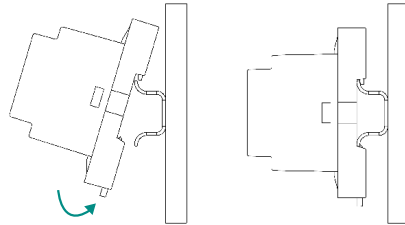

Note: To remove the module, pull the tab downwards to release it.

Connection

The control module of radiant elements is a device that is connected to the Airzone connection bus on the main control board.

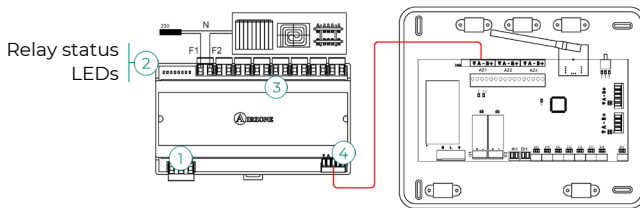

The characteristics of the control relays ③ are I_{max} 10 A at 110/230 VAC voltage free. To control higher power elements, the use of contactors of the power to be controlled is recommended. Remember to connect the neutral directly from the circuit to the element to be controlled.

The operation of the relays is indicated as follows:

OX = demand of the radiant element in zone X.

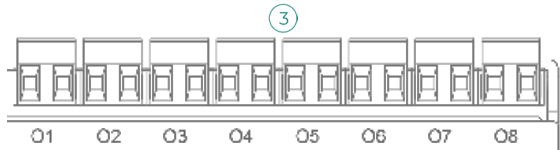

For connection to the Airzone connection bus on the main control board ④, there is one 5-pin terminal. Fix the cables with the screws on the terminal, following the color code.

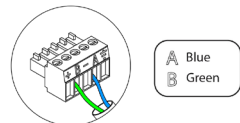

The power connection to the module is via a 3-pin terminal ①. Fix the cables with the screws on the terminal, following the polarity.

Once powered, the control module of radiant elements performs a sequential opening and closing of all relay outputs. This operation is repeated once a week to ensure correct operation of the valves.

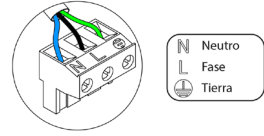

The connection to the external power supply must include a main switch or other method of disconnection that includes a constant separation for all polarities, in accordance with appropriate local and national regulations. The system will automatically restart if the power supply is turned off. **Use separate circuits for the unit that is to be controlled and the power supply to the system.**

WIRED THERMOSTAT

Elements

AZCE6BLUEZEROC

For further information, see the [technical fact sheet](#).

AZCE6THINKC

For further information, see the [technical fact sheet](#).

AZCE6LITEC

For further information, see the [technical fact sheet](#).

Assembly

Airzone wired thermostats are surface mounted on a support. Remember that the maximum recommended distance for this device is 40 meters. For wall mounting, follow these steps:

- Separate the back of the thermostat and make the relevant connections.
- Fix the back of the thermostat to the wall.
- Place the display over the fixed support.
- Place the anti-vandalism rods to better hold the thermostat in place (optional).

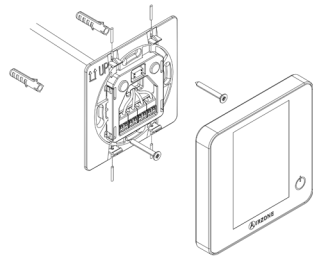

Connection

Airzone thermostats are elements that are connected to the Airzone connection bus on the main control board. Fix the cables with the screws on the terminal, following the color code.

Important: Use the tool provided to press on the fastening tabs.

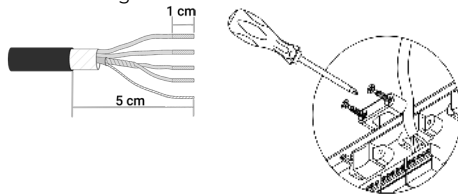

Main control board connection

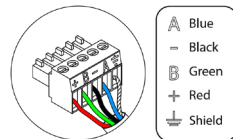

Thermostat connection

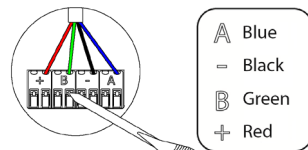

Press

WIRELESS THERMOSTATS

Elements

AZCE6THINKR

For further information, see the [technical fact sheet](#).

AZCE6LITER

For further information, see the [technical fact sheet](#).

Assembly

Airzone wireless thermostats are surface mounted on a support. Remember that the maximum recommended distance for this device is 40 meters.

- Remove the back of the thermostat and insert the CR2450 button battery.
- Fix the back of the thermostat to the wall.
- Place the display over the fixed support.
- Place the anti-vandalism rods to better hold the thermostat in place (optional).

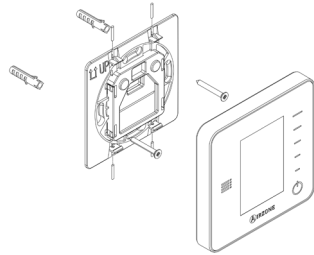

Note: If you wish to change the battery, please see the [User's Manual](#).

AIRZONE CONTROL GATEWAY-3 SPEED FANCOIL (AZX6FANCOILZ)

For further information, see the [technical fact sheet](#).

Elements

EN

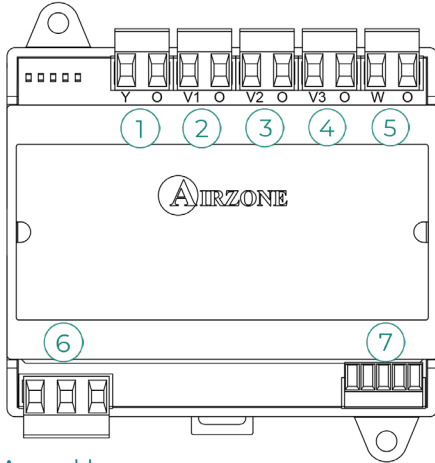

No.	Description
1	Cooling air demand
2	Speed 1
3	Speed 2
4	Speed 3
5	Heating air demand
6	Power supply
7	AC unit bus

Assembly

This device is DIN rail or wall mounted. This module is externally powered at 110/230 VAC. The location and assembly of this module must comply with current electronic regulations.

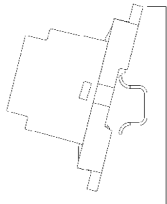

Mounted using DIN rail

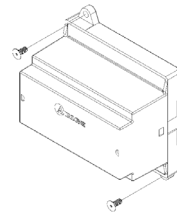
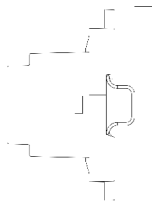

Mounted on wall

Note: To remove the module on DIN rail, pull the tab downwards to release it.

Connection

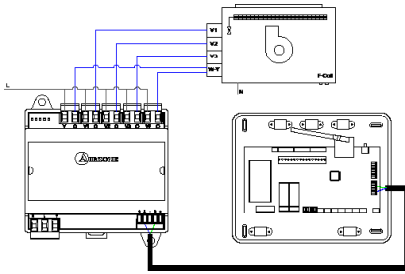

2-pipe installation

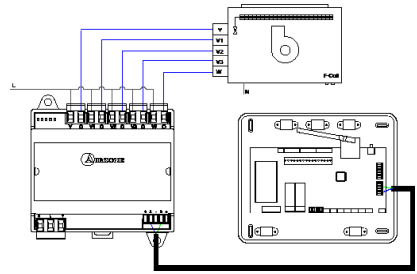

4-pipe installation

The characteristics of the control relays (1)(2)(3)(4)(5) are I_{max} 10 A at 110/230 VAC voltage free. To control higher power elements, the use of contactors of the power to be controlled is recommended.

For connection to the main control board AC unit bus (7) there is one 4-pin terminal. Fix the cables with the screws on the terminal, following the color code. Only use the shield on the connector on the main control board side.

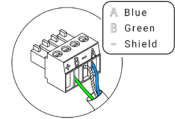

The power connection to the module (6) is via a 3-pin terminal. Fix the cables with the screws on the terminal, following the polarity.

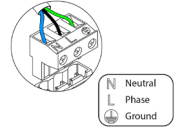

The connection to the external power supply must include a main switch or other method of disconnection that includes a constant separation for all polarities, in accordance with appropriate local and national regulations. The system will automatically restart if the power supply is turned off. **Use separate circuits for the unit that is to be controlled and the power supply to the system.**

AIRZONE CONTROL GATEWAY-0-10 V FANCOIL (AZX6010VOLT SZ)

For further information, see the [technical fact sheet](#).

Elements

EN

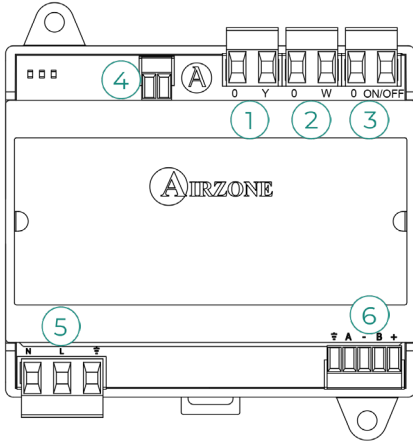

No.	Description
1	Cooling air demand
2	Heating air demand
3	Ventilation demand
4	Control of fan
5	Power supply
6	AC unit bus

Assembly

This device is DIN rail or wall mounted. This module is externally powered at 110/230 VAC. The location and assembly of this module must comply with current electronic regulations.

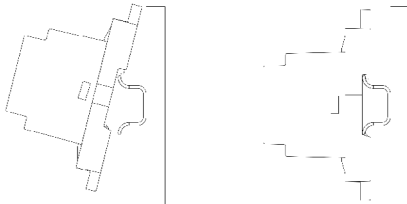

Mounted using DIN rail

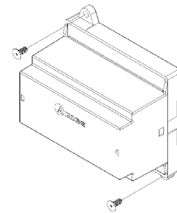

Mounted on wall

Note: To remove the module on DIN rail, pull the tab downwards to release it.

Connection

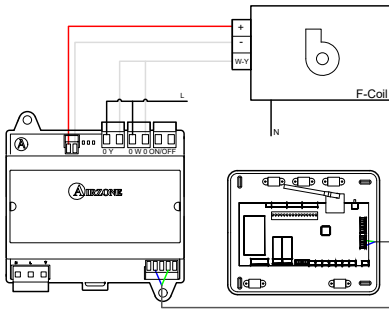

2-pipe installation

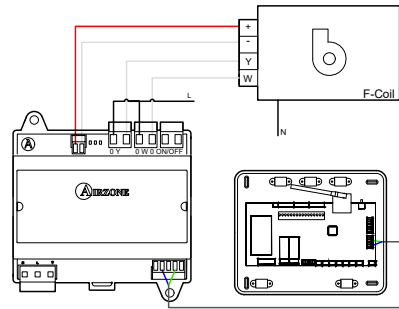

4-pipe installation

The characteristics of the control relays ① ② ③ are I_{max} 10 A at 110/230 VAC voltage free. To control higher power elements, the use of contactors of the power to be controlled is recommended.

For connection to the main control board AC unit bus ⑥ there is one 4-pin terminal. Fix the cables with the screws on the terminal, following the color code. Only use the shield on the connector on the main control board side.

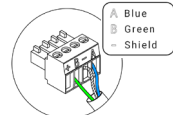

The power connection to the module ⑤ is via a 3-pin terminal. Fix the cables with the screws on the terminal, following the polarity.

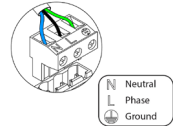

The connection to the external power supply must include a main switch or other method of disconnection that includes a constant separation for all polarities, in accordance with appropriate local and national regulations. The system will automatically restart if the power supply is turned off. **Use separate circuits for the unit that is to be controlled and the power supply to the system.**

AIRZONE CONTROL GATEWAY-ELECTROMECHANICAL UNIT (AZX6ELECTROMECH)

For further information, see the [technical fact sheet](#).

Elements

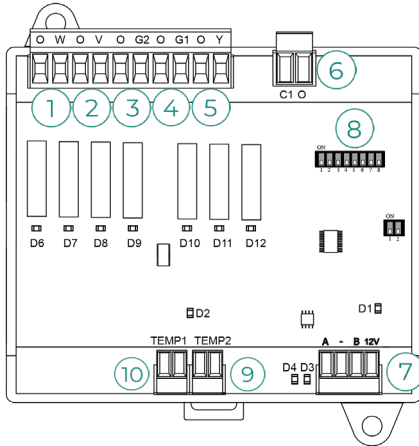

No.	Description
1	Heating mode
2	Ventilation mode
3	Compressor 2
4	Compressor 1
5	Cooling mode
6	Boiler
7	AC unit bus
8	Microswitch
9	Boiler probe
10	Unit probe

Assembly

This device is DIN rail or wall mounted. This module is powered via the AC unit bus of the main control board. The location and assembly of this module must comply with current electronic regulations.

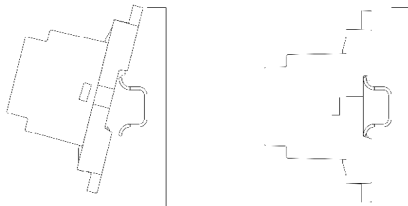

Mounted using DIN rail

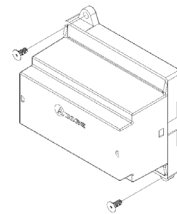

Mounted on wall

Note: To remove the module on DIN rail, pull the tab downwards to release it.

Connection

EN

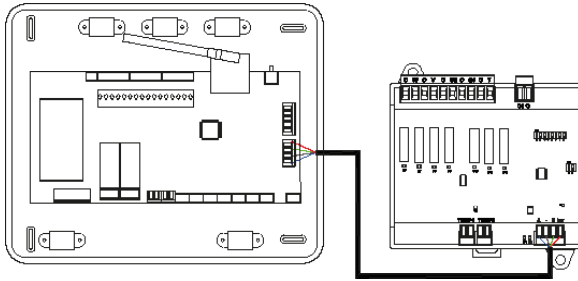

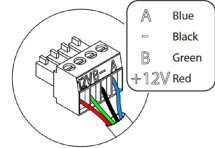

The characteristics of the control relays ①②③④⑤ are 24/48 VAC voltage free. To control higher power elements, the use of contactors of the power to be controlled is recommended.

For connection to the main control board AC unit bus ⑦ there is one 4-pin terminal. Fix the cables with the screws on the terminal, following the color code. Only use the shield on the connector on the main control board side.



The connection to the external power supply must include a main switch or other method of disconnection that includes a constant separation for all polarities, in accordance with appropriate local and national regulations. The system will automatically restart if the power supply is turned off. **Use separate circuits for the unit that is to be controlled and the power supply to the system.**

The operation logic of the microswitch ⑧ is as follows:

Meaning		
	Compressor start up time	ON: 4 min
		OFF: 10 s
	Steady ventilation	ON: permanently on except when in Stop mode
		OFF: only if there is demand
	1 or 2 stage unit	ON: 2 stages
		OFF: 1 stage

The operation logic of the relays ①②③④⑤⑥ is as follows:

HVAC	Demand	①	②	③	④	⑤	⑥
Stop	-	-	-	-	-	-	-
Ventilation	Yes	-	ON	-	-	-	-
	No	-	-	-	-	-	-
Cooling air (1 stage)	Yes	-	ON	-	ON*	ON	-
	No	-	-	-	-	ON	-
Cooling air (2 stages)	If return temp. < 28°C	ON	ON	ON	ON	ON	-
	If return temp. > 28°C	ON	ON	-	ON*	ON	-
	No	ON	-	-	-	ON	-
Heating air (1 stage)	Yes	ON	ON	ON	ON*	-	-
	No	ON	-	-	-	-	-
Heating air (2 stage)	If return temp. < 18°C	ON	ON	ON	ON	-	-
	If return temp. > 18°C	ON	ON	-	ON*	-	-
	No	ON	-	-	-	-	-
Radiant heating	Yes	ON	-	-	-	-	-
	No	ON	-	-	-	-	-
Combined heating	Dif. > Z°C	ON	ON	ON	ON	-	ON
	Dif. < Z°C	ON	-	-	-	-	ON
	No	ON	-	-	-	-	-

Note: The activation of compressor outputs ③ and ④ alternate.

WEBSERVER AIRZONE CLOUD

Elements

Webserver Airzone Cloud Wi-Fi Dual 2.4-5G (AZX6WSC5GER)

For further information, please refer to the [technical datasheet](#).

EN

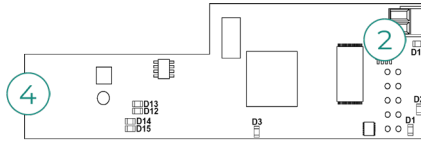

Webserver HUB Airzone Cloud Dual 2.4-5G/Ethernet (AZX6WSPHUB)

For further information, please refer to the [technical datasheet](#).

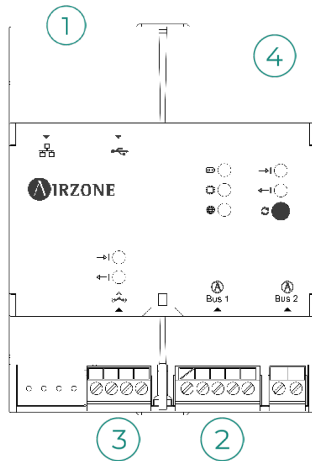

No.	Description
①	Ethernet
②	Domotic Bus connection
③	Integration gateway
④	WiFi

Assembly

The Webserver Airzone Cloud Wi-Fi Dual 2.4-5G (AZX6WSC5GER) is integrated in the domotic bus of the system's control board or in the external domotic bus of the production control board. It has a 5-pin terminal. Disconnect the terminal to which you wish to connect the Webserver and engage the connector.

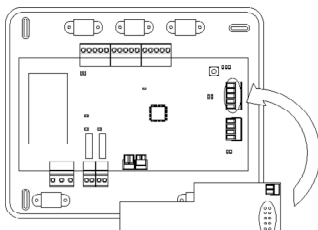

System control board - AZX6WSC5GER

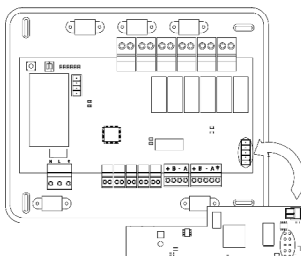

AX6CCPGAWI - AZX6WSC5GER

Note: Remove the fixing post from the Webserver for mounting on the CCPGAWI

The Webserver HUB (AZX6WSPHUB) is DIN rail- or surface-mounted. The location and the assembly of this module must be compliant with the applicable electronic regulations.

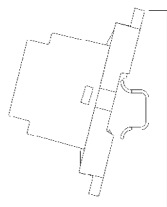

DIN-rail mounting

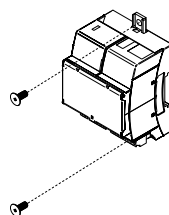
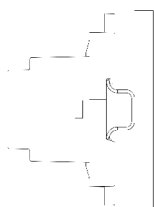

Wall mounting

Note: To remove the module in the DIN rail, pull the reed downwards to release it.

Connection

For connection to other system control boards, use the 2-pin terminal to connect the Webserver Airzone Cloud to the control board's domotic bus. Attach the wires with the terminal screws following the colour code.

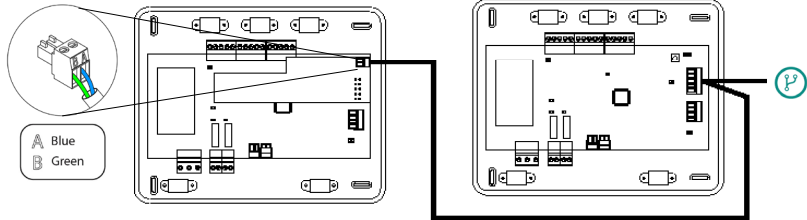

AZX6WSC5GR from a system control board to other system control boards

If the Webserver Airzone Cloud is connected to the CCP, use the CCP's internal domotic bus to connect to the system control board.

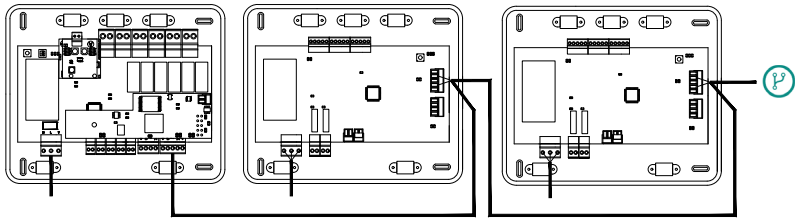

AZX6WSC5GR from AX6CCPGAWI to system control boards

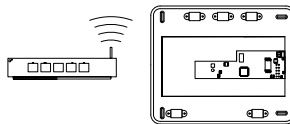

ROUTER - AZX6WSC5GR

The connection icon  indicates that the same connection can be made for up to 32 systems.

Note: Remember that for this module to operate properly, all the control boards must be addressed (see the Advanced system configuration section)

The Webserver HUB is connected to the system's control board domotic bus.

There is one 5-pin terminal available for connection to the domotic bus ② of the control board. Attach the wires with the terminal screws following the colour code. Use the ground only in the connector on the side of the control board.

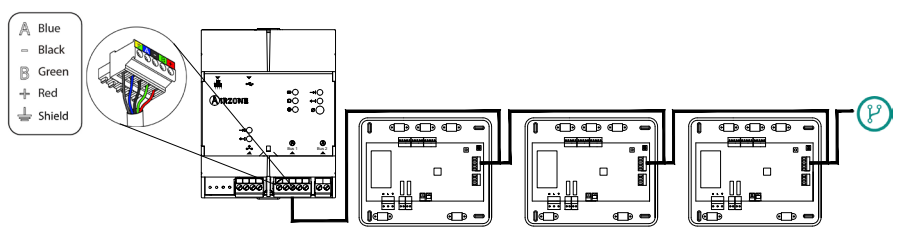

AZX6WSPHUB from a system control board to other system control boards

To connect the Webserver HUB to a CCP, use the latter's external domotic bus 2.

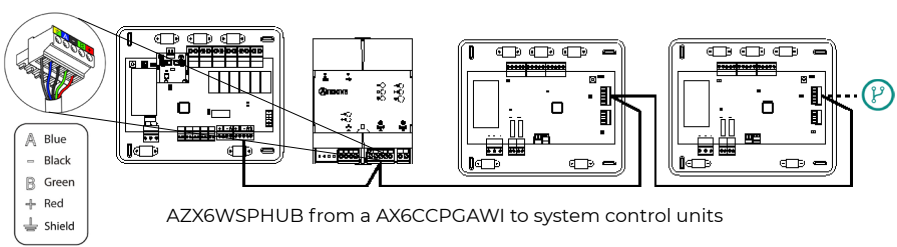

AZX6WSPHUB from a AX6CCPGAWI to system control units

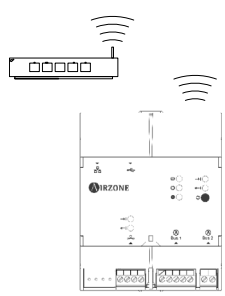

ROUTER (Wi-Fi) - AZX6WSPHUB

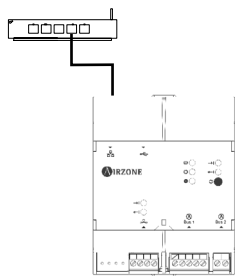

ROUTER (Ethernet) - AZX6WSPHUB



All Airzone systems must be connected to the Internet to provide technical support.

- AZX6WSC5GER / AZX6WSPHUB: **Only one Webserver per installation** needs to be connected (control up to 32 systems).

SUPERMASTER CONTROLLER (AZX6CSMASTER [S/E] [B/G])

Important: This device is not compatible with the production control board (AZX6CCP).

Assembly

EN

Surface mounted (AZX6CSMASTERS):

- Separate the back of the thermostat from the wall support.
- Attach the support directly to the wall or by fixing to the switch box.
- Place the back part on the already fixed support by passing the cable through the hole. Make sure that it is secured by the tabs on the support. Make the necessary connections.
- Place the display over the back part.

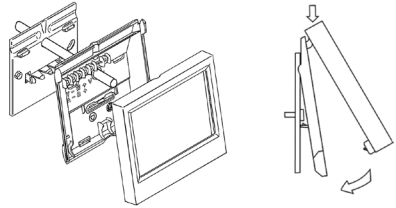

For further information, see the [technical fact sheet](#).

Embedded (AZX6CSMASTERE):

The embedded supermaster controller is installed in the wall in 100x100 mm screwed junction boxes. Compatible mounting boxes are:

- Solera 362 (100x100 mm)
- Jangar 2174 (100x100 mm)
- IDE CT110 (100x100 mm)
- Fematel Ct35 (100x100 mm)

For mounting, follow these steps:

- Remove the display frame from the rest of the assembly and make the relevant connections.
- Use the washers and screws to fix the display to the embedded box.
- Replace the frame. Make sure that it is properly secured.

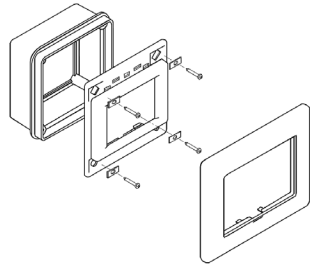

For further information, see the [technical fact sheet](#).

Connection

The Supermaster controller is an element that connects to the automation bus on the system's main control board.

For the surface-mounted supermaster, use the tabs on the back of the supermaster. Fix the cables with the screws on each tab, following the color code.

In the case of the embedded supermaster, there is one 5-pin terminal located on the rear of the supermaster. Fix the cables with the screws on the terminal, following the color code.

Note: To configure it, follow the steps in the [User's Manual](#).

Remember that, for this module to work correctly, all the main control boards in the installation must be addressed (see System advanced settings section).

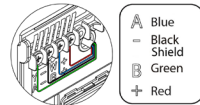

- A Blue
- Black Shield
- B Green
- + Red

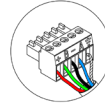

- A Blue
- Black Shield
- B Green
- + Red
- ↓ Shield

PRODUCTION CONTROL BOARD

Elements

AZX6CCPGAWI

For further information, see the [technical fact sheet](#).

EN

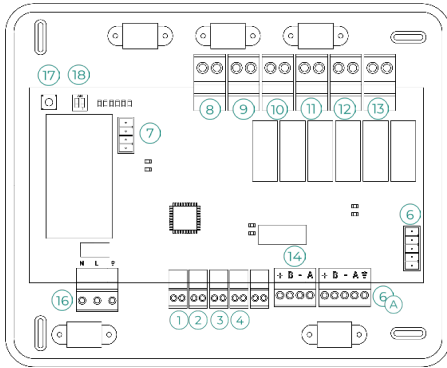

Important: This element is not compatible with the supermaster controller (AZX6CSMASTER).

Assembly

The production control board is delivered in a screwed box for surface mounting. The location and installation of this element must comply with the current electronic regulations. To mount the production control board, follow these steps:

- Locate the production control board close to the AC unit to be controlled.
- Unscrew the cover to fix the rear part to the wall.
- Once all connections have been made, screw the cover back on.

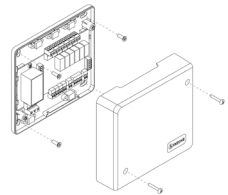

Connection

Digital inputs

The production control board is equipped with 4 digital inputs for external control of Airzone systems. These inputs are configured as normally open. For connection, the use of shielded cable is recommended.

- ① **DHW:** This input activates the DHW mode, whereby all Acuazone/Innobus Pro32 and Flexa 4.0 systems that are working in air heating will stop and display the DHW message on the zone thermostats. This function is recommended for air to water installations when the air to water unit starts to produce DHW for the production of heating and air conditioning.
- ② **HEATING:** This input activates the semi-forced heating mode in all the systems in the installation. It allows the selection of the modes: Stop, Heating and Ventilation.
- ③ **COOLING:** This input activates the semi-forced cooling mode in all the systems in the installation. It allows the selection of the modes: Stop, Cooling, Dry and Ventilation.
- ④ **STOP:** This input activates the Stop mode in all the systems in the installation.

Domotic Bus ⑥

The outdoor domotic bus allows several systems to be interconnected in order to manage all of them, using the control peripherals offered by Airzone or their integration into a higher-level control network.

To connect the **A** domotic bus, there are two 5-pin terminals. This system only uses bus connections. Fix the cables with the screws on the terminal, following the color code.

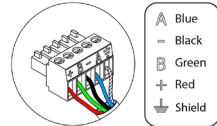

Note: Remember that, for this main control board to work correctly, all the main control boards in the installation must be addressed (up to 32 systems) (see System advanced settings section).

In the case of the Airzone Cloud Webserver connection, remove the Webserver fixing post and fit the connector on the outdoor domotic bus.

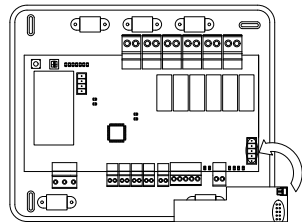

Connector bus for air to water gateways 7

The AC unit bus makes it possible to connect various production unit control gateways to the installed air-water unit.

To connect these integrated gateways, disconnect the AC unit bus terminal and fit the connector and the gateway fixing post.

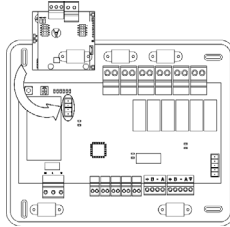

Connection of gateway
AZX6GAW to AZX6CCPGAW

Control relays

This device has 6 relays for controlling the installation. The characteristics of the control relays are I_{max} 10 A at 110/230 VAC voltage free. To control higher power elements, the use of contactors of the power to be controlled is recommended.

Important: Remember to connect the neutral directly from the circuit to the element to be controlled.

Depending on the type of installation configured, the control relays will have a logic adapted to the installation:

- **Aerothermal**

Mode	Demand	Control relays					
		8	9	10	11	12	13
Stop	Off	-	-	-	-	-	-
	Air	ON	-	ON	-	-	-
Cooling	Radiant	ON	-	-	ON	-	-
	Off	-	-	-	-	-	-
	Air	-	ON	-	-	ON	-
Heating	Radiant	-	ON	-	-	-	ON
	Off	-	-	-	-	-	-
	On	-	-	-	-	-	-
Dry	Off	-	-	-	-	-	-
	On	-	-	-	-	-	-
Ventilation	On	-	-	-	-	-	-
	Off	-	-	-	-	-	-

- **2 pipes / 4 pipes**

Mode	Demand	Control relays					
		⑧	⑨	⑩	⑪	⑫	⑬
Stop	Off	-	-	-	-	-	-
Cooling	Air	ON	-	ON	-	-	-
	Radiant	ON	-	-	ON	-	-
	Off	ON	-	-	-	-	-
Heating	Air	-	ON	-	-	ON	-
	Radiant	-	ON	-	-	-	ON
	Off	-	ON	-	-	-	-
Dry	On	ON	-	-	-	-	-
	Off	ON	-	-	-	-	-
Ventilation	On	-	-	-	-	-	-
	Off	-	-	-	-	-	-

- **RadianT***

Mode	Demand	Control Relays					
		⑧	⑨	⑩	⑪	⑫	⑬
Stop	Off	-	-	-	-	-	-
Cooling	Radiant	ON	-	-	ON	-	-
	Off	ON	-	-	-	-	-
Heating	Radiante	-	ON	-	-	-	ON
	Off	-	ON	-	-	-	-
Dew Warning Active	On	ON	-	ON	-	-	-
	Off	ON	-	ON	-	-	-

**Only for Airzone RadianT365 system (AZRA6)*

For Acuazone and Innobus Pro 32 systems versions v.4.4.1 or higher: In any configuration of the Acuazone central operating logic, zones with air flow stage configured as DX (Direct Expansion) will not generate air demand in the production control board. Remember that in both zoned or mixed configurations, when the air flow stage of a zoned area is modified, the same configuration will apply to the rest of the zones in the group.

Important: In order to optimize the production temperature of the air to water units, the following combinations will not generate air demand in the production control board:

- Airzone 3.0 controller gateway (AZX6GTCxxx) in the Flexa 4.0 and Innobus Pro8 system main control boards.
- Airzone communication gateway (AZX6QADAPTxxx) in the Flexa 4.0 and Innobus Pro8 system main control boards.
- Airzone control gateway-Electromechanical unit (AZX6ELECTROMECH) in Flexa 4.0 and Innobus Pro8 system main control boards.
- Airzone individual unit zone module (AZDI6MCIFR [C/R] / AZDI6MCxxx [C/R] / AZDI6ZMOxxx [C/R]) in Acuazone e Innobus Pro32 (v.4.4.0 or lower) systems when configured as a zoning system or mixed system.

Integration bus output 14

It has a 4-pin terminal for integration. Only available in configurations without webserver.

Power supply 16

This connector supplies power to the production control board and consequently to the elements connected to it. External power supply at 110/230 VAC. The power connection to the module is via a 3-pin terminal. Fix the cables with the screws on the terminal, following the color code.

For increased safety, fix the cables to the main control board using the turrets.

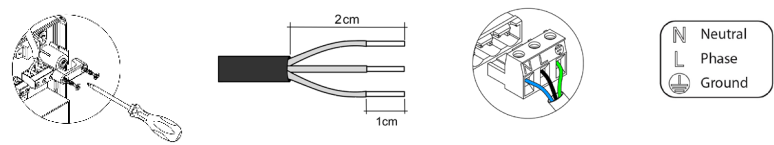

The connection to the external power supply must include a main switch or other method of disconnection that includes a constant separation for all polarities, in accordance with appropriate local and national regulations. The system will automatically restart if the power supply is turned off. **Use separate circuits for the unit that is to be controlled and the power supply to the system.**





SW1 17

A short press on SW1 forces the cloud production control board to search for the systems connected to it and to set the addressing configuration. To reset the CCP, press SW1 for 10 seconds.



SW2 18

The SW2 microswitch configures the type of installation to be controlled by the production control board. The operation logic of the microswitch is as follows:

Meaning			
 1 2	 1 2	 1 2	 1 2
Aerothermal	2 pipes	3/4 pipes	Radiant*

**Only for Airzone RadianT365 system (AZRA6)*

Once all the connections have been made, make sure the cover of the main control board is correctly replaced.

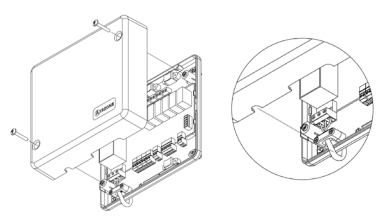

AIRZONE-KNX INTEGRATION GATEWAY (AZX6KNXGTWAY)

For further information, see the [technical fact sheet](#).

Elements

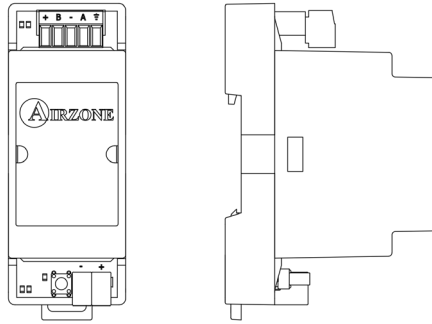

Assembly

This device is DIN rail mounted. It is powered by the main control board automation bus and the installation's KNX bus. The location and assembly of this module must comply with current electronic regulations.

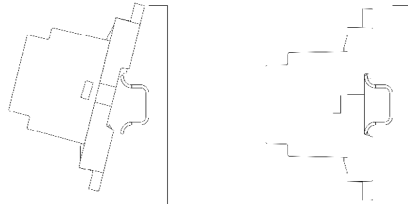

Note: To remove the module, pull the tab downwards to release it.

Connection

The Airzone-KNX integration gateway is connected to the automation bus on the main control board. To do this, there is one 5-pin terminal. Fix the cables with the screws on the terminal, following the color code.

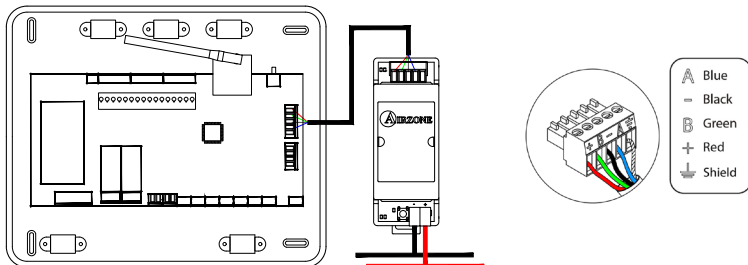

To configure it, follow the steps described in the [KNX Installation Manual](#).

AIRZONE CONSUMPTION METER (AZX6ACCCON)

For further information, see the [technical fact sheet](#).

Assembly

This device is DIN rail mounted. This module is externally powered at 110/230 VAC. The location and assembly of this module must comply with current electronic regulations.

EN

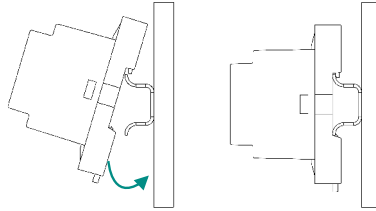

Note: To remove the module, pull the tab downwards to release it.

Connection

The Airzone consumption meter is an element that is connected by means of an ammeter clamp (1) to the wiring of the outdoor unit to measure the installation's consumption.

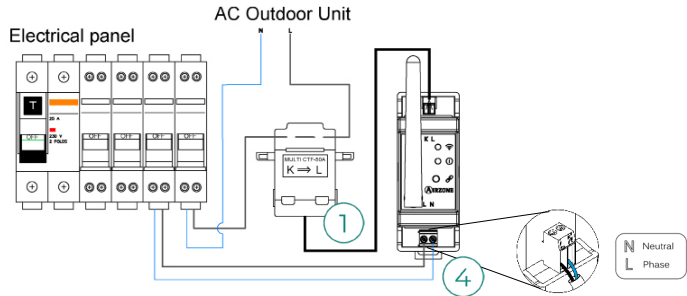

The power connection to the module (4) is via a 2-pin terminal. Fix the cables with the screws on the terminal, following the polarity.

To connect to the Airzone system main control board, carry out the following steps:

1. Open the system's wireless channel.
2. Press  to associate the consumption meter.
3. The LED (1) will be displayed in search status (blue) and will change to associated (green). If it doesn't, please refer to the self-diagnostics section.

Reset

If you need to reset the consumption meter to factory settings, press and hold the button  until the LED (1) changes to search status (blue). Wait for the LEDs to return to their normal status and then repeat the initial configuration.

System Installation

EN

CONTROL BOARD INSTALLATION

1. Locate the control board close to the unit to be controlled.
2. Unscrew the cover securing the back part to the wall.
3. Make all the connections and screw the cover again.

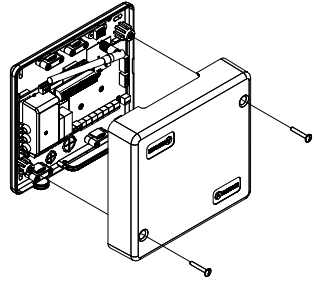

THERMOSTAT INSTALLATION

1. Remove the back of the thermostat.
2. Fix the back of the thermostat to the wall.
3. Connect the main control board to any of the three terminals **AZ1, AZ2 o AZ3**. Fix the cables using the main control board turrets.
If your thermostat is a wireless thermostat, insert the CR2450 button battery.
4. Place the display over the fixed support.
5. Place the anti-vandalism rods (optional) to better hold the thermostat in place.

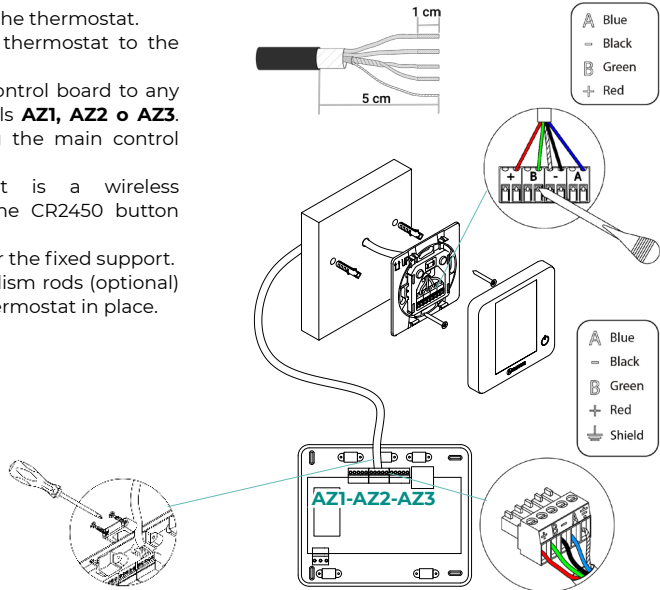

CONNECTING THE MOTORIZED ELEMENTS

Connect each output (**M1...M8**) to the actuator of its corresponding control zone. Do not connect more than two actuators per output. Use the Airzone cable (2x0.75 mm²) for the connection. Highest recommended length 20 m.

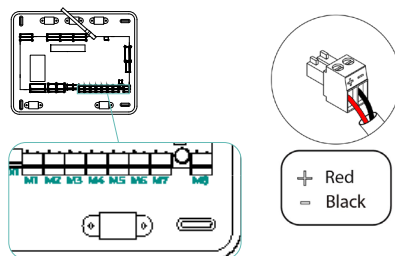

CONNECTION TO THE INDOOR UNIT

Communications gateway option

Connect the communication gateway to the **IU** port of the main control board. Follow the instructions of the gateway datasheet. It is recommended to install the thermostat of the unit.

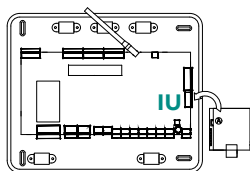

Control gateway option

Connect the communication gateway to the **IU** port using Airzone wire 2x0.22 mm² (use the shield only on the connector of the main control board).

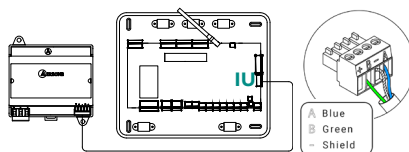

O1 port option

Use the main control board **O1** port to perform the start-stop of the unit following the manufacturer's instructions. I_{max} 1 A, V_{max} 24 / 48 Vdc.

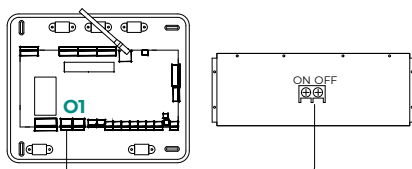

OTHER PERIPHERALS

Follow the instructions on their technical data sheet.

Important: For elements with external power supply at 110/230 VAC, it is only necessary to connect poles "A" and "B" of the bus for communications.

EN

POWER SUPPLY TO THE SYSTEM

Use input power supply to power the main control board at 110/230 VAC as well as any other control elements that require external power supply. Use 3x1.5 mm² cable. For added security, secure the wires using the turret.

i *The connection to the external power supply must include a main switch or other method of disconnection that includes a constant separation for all polarities, in accordance with appropriate local and national regulations. The system will automatically restart if the power supply is turned off. Use separate circuits for the unit that is to be controlled and the power supply to the system.*

Once all the connections have been made, make sure the cover of the main control board is correctly replaced.

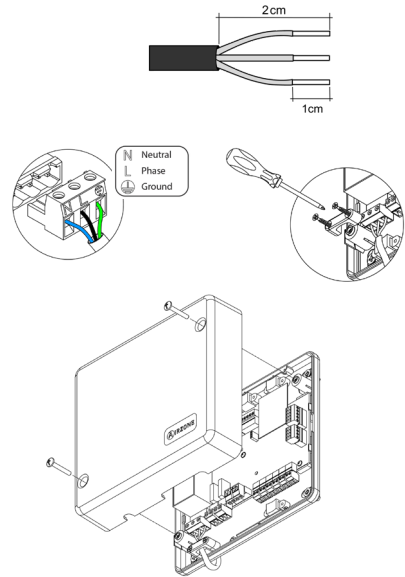

Checking the Installation

Check the following items:

1. Status of the main control board LEDs and of the other control elements connected. Consult the Self-diagnostics section on each element's technical fact sheet.
2. The main control board LEDs indicating the opening of motorized elements light up in sequence.
3. Power supply to wired and wireless thermostats.

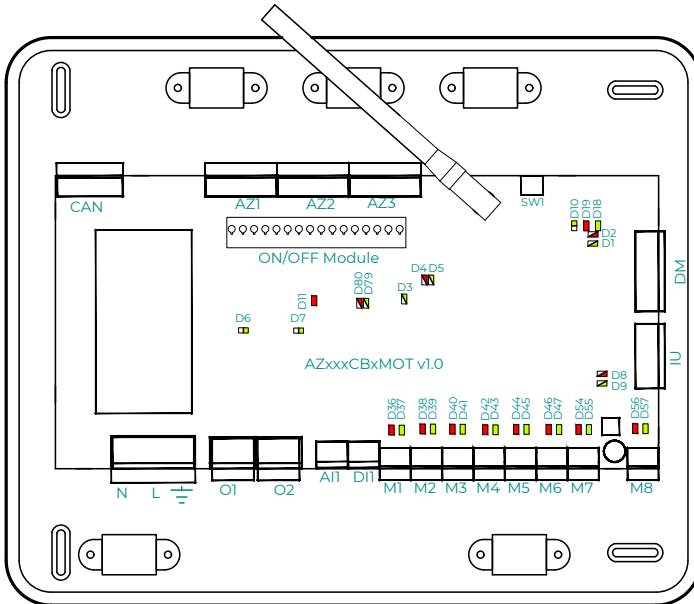

-  Blinking
-  Steady
-  Switches

- M1...M8
-  (Green) Damper opening
-  (Red) Damper closing

Initial Configuration

EN

AIRZONE BLUEFACE ZERO

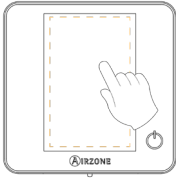

Languages:

- Spanish
- English
- French
- Italian
- Portuguese
- German

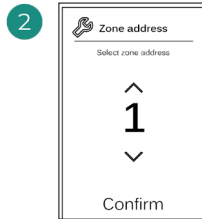

Select the zone associated to this thermostat. Each zone has a corresponding control output (actuator output or radiant element control relay output).

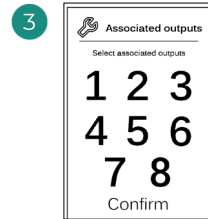

The system allows you to associate more than one control output to a zone if needed. It is therefore possible to manage several control outputs from a single thermostat.



Master: Allows the control of all installation parameters.

Zone: Only allows the control of the zone parameters.

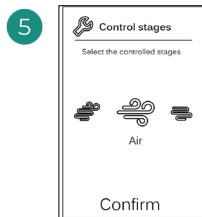

Stages to be controlled:

- Air
- Radiant
- Combined

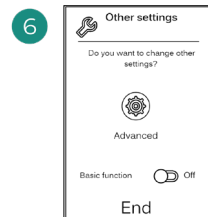

Finish the process, access the advanced settings and/or activate the basic function (the latter allows on/off, speed setting, operation mode setting and temperature setting).

AIRZONE THINK

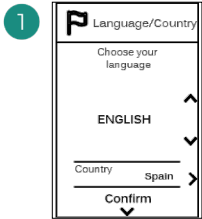
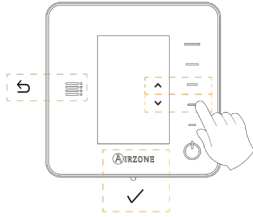

Languages:

- Spanish
- English
- French
- Italian
- Portuguese
- German

2

Wireless Think
 Open the wireless association channel. To do so, click SW1. Once opened, you have 15 minutes to perform the association. You can also open the wireless association channel through the Blueface zero thermostats.

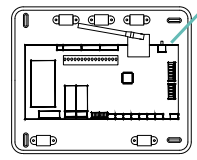

SW1

IMPORTANT: Remember not to have more than one channel open in the same installation at the same time.

Wired Think
 Go to step 4.

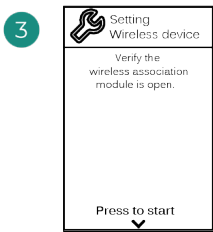

Start the search for the wireless channel.

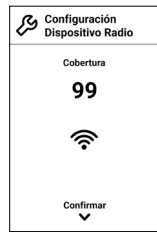

Check that the signal range is optimal (minimum 30%).



Select the zone associated to this thermostat. Each zone has a corresponding control output (actuator output or radiant element control relay output).

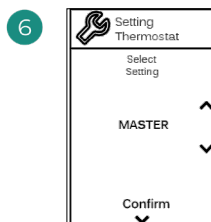
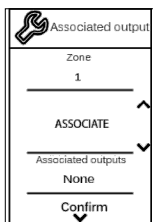
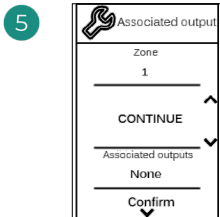

The system allows you to associate more than one control output to a zone if needed. It is therefore possible to manage several control outputs from a single thermostat.

Master: Allows the control of all installation parameters.

Zone: Only allows the control of the zone parameters.

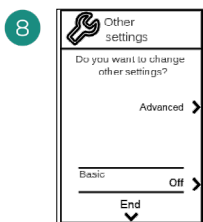
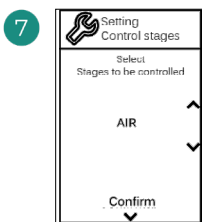

*Stages to be controlled:

- Air
- Radiant
- Combined

Finish the process, access the advanced settings and/or activate the *basic function (the latter allows on/off, speed setting, operation mode setting and temperature setting).

*Not available on 3.5.0 or later version AZCE6THINKR

AIRZONE LITE



1

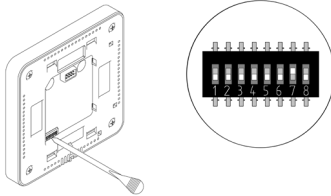

Select the zone associated to this thermostat by raising the microswitch corresponding to the zone.

2

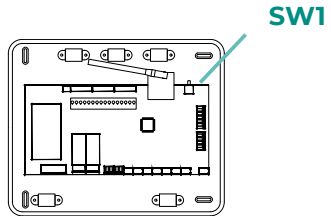

Wireless Lite

Open the wireless association channel. To do so, click SW1. Once opened, you have 15 minutes to perform the association. You can also open the wireless association channel through the Blueface zero thermostats.

IMPORTANT: Remember not to have more than one channel open in the same installation at the same time.

Wired Lite

Go to step 3.

3

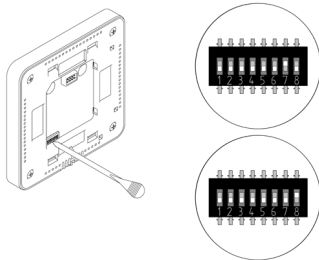

Select other control outputs associated to the zone if necessary. The zone address will be the one with the lowest number selected (for example, associated output 8 to the zone address 7).

4

If you want to configure other thermostat settings you must access the zone advanced settings menu from an Airzone Blueface zero thermostat.

The icon  will blink 5 times in green to indicate that the association is correct. If the icon blinks once in red, this indicates that the zone is occupied, and if it blinks twice in red, it means that the thermostat is not in signal range.

Remember: Should it be necessary to change the zone number, first reset the thermostat and initiate the association sequence.

CHECKING THE INITIAL CONFIGURATION

Check the following items:

1. **AC unit-system communication:** Set the Airzone system to an operation mode other than Stop and turn on the zone to generate demand. Verify that the mode imposed on the master thermostat appears on the indoor unit thermostat and that the set-point temperature changes on the same.
2. **AC unit-system communication:** Set the Airzone system to Stop mode and verify that the AC unit turns off and dampers open.
3. **Opening/closing of the dampers and control outputs:** Turn on and generate demand in all the zones. Then turn each zone off and on to check that the associated control outputs are correct.
4. Check that the **static pressure** in the ducted AC unit is in accordance with the conditions of the airflow distribution network in which it is installed (see the manufacturer's manual for the AC unit if you need to modify this parameter).

SYSTEM RESET

If you need to return the system to factory settings, press and hold **SW1** until **LED D19** stops blinking. Wait for the LEDs to return to their normal status and then repeat the initial configuration.

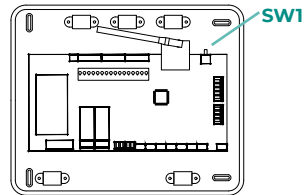

ZONE RESET

For Blueface zero and Think thermostats, follow the steps indicated in the Advanced settings menu, Zone parameters.

For Lite thermostats, lower all microswitches and replace the thermostat in its base. The icon  will blink twice in green confirming that the reset has been completed.

System Advanced Settings

AIRZONE BLUEFACE ZERO

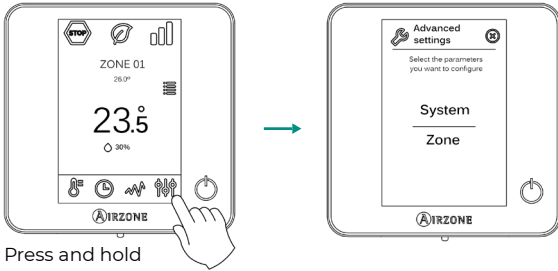

AIRZONE THINK

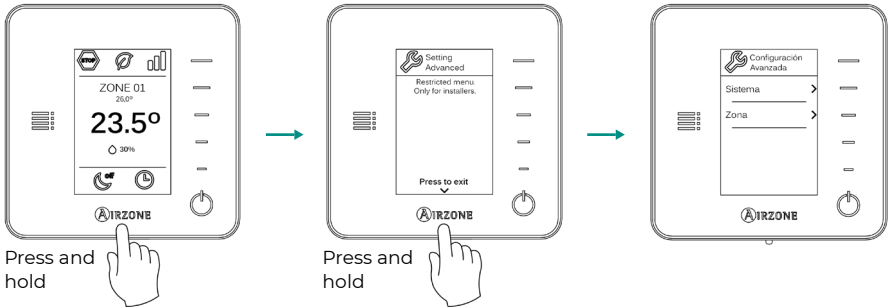

AIRZONE CLOUD

Advanced system configuration can be performed from the Airzone Cloud application (see Airtools section of the [Airzone Cloud Installation Manual](#)).

The following parameters can be configured:



















- System parameters
- Zone parameters
- Production parameters



SYSTEM PARAMETERS

- **System address.** (Not available on systems with BACnet gateway) This allows you to define the number of the system in your installation. By default, it displays the value 1. The system will show the free address values with a maximum value of 99.

If you have address 1 and have an Airzone production control board (AZX6CCPGAWI) in the installation, you can use the Supermaster function, which imposes the operation mode of system 1 on the other systems connected to the AZX6CCPGAWI in a semi-forced way:

Operation mode of system 1	Available operation modes of the other systems
	
	   
	   
	  
	 

- **Temperature range¹.** This allows you to select the maximum temperature for heating mode (19 – 30 °C) and minimum temperature for cooling mode (18 – 26 °C), in steps of 1 °C. If you want, you can disable any of the modes. By default, the maximum heating temperature is set to 30 °C and the minimum cooling temperature to 18 °C.
- **Combined stage¹.** (Only available in installations with AZCE6OUTPUT8 modules) This allows you to activate/deactivate the combined stage of the "Control stages" parameter in the user "Zone settings" menu.
- **Hysteresis Config¹.** This defines the temperature differential between the room temperature and the set-point temperature to begin to apply the RadianT algorithm, which aims to prevent underfloor heating installations overheating. In installations with radiators, set this value to 0 °C. By default, it is set to 0 °C.
- **Type of opening*¹.** This allows you to enable/disable the proportionality of the system dampers. Proportionality scales the opening or closing of the damper in 4 steps according to the temperature demand of the zone, adjusting the zone airflow rate. By default, it is set to All/Nothing.

**Note: Changing this parameter affects all motorized dampers in the installation. It is not recommended for RINT and RIC smart grilles.*

¹ Parameters not available in Airzone Blueface zero thermostats

- **Standby mode¹.** *(Only for Airzone Cloud)* Configuration of the operation logic of the motorized elements when there is no demand on the system. This is disabled by default. If enabled, from Airzone Cloud only the following can be configured:
 - Standby mode for cooling: allows you to activate or deactivate Standby in cooling mode
 - Standby mode for heating: allows you to activate or deactivate Standby in heating mode
 - Heating Hysteresis: sets a hysteresis value in heating mode (by default 3°C)
 - Cooling Hysteresis: sets a hysteresis value in cooling mode (by default 1°C)
- **Relay settings¹.** *(Only for Airzone Cloud)* This allows you to change the operation logic of the main control board's CMV/Boiler relay. By default, it is set to CMV.
- **Filter maintenance¹.** *(Only for Airzone Cloud)* It is used to enable or disable the warning, edit hours of operation or reset the filter maintenance count.
- **Return temperature¹.** **(Not available on 3.5.0 or later version AZCE6THINKR)** *(Only available in installations with AZX6SONDPROTEC protection probe)* This allows you to define the system's cut-off temperatures for the protection of the AC unit in heating mode (32 °C, 34 °C and 36 °C) and cooling mode (6 °C, 8 °C and 10 °C). By default, the system's heating cut-off temperature is set to 34 °C and the cooling cut-off temperature is set to 8 °C.
- **Q-Adapt¹.** *(Only for Airzone Think thermostats)*
 1. **In direct expansion units.** This allows you to define the airflow control algorithm that best fits the duct installation. The options available are:
 - **Maximum:** the system operates at maximum speed regardless of the number of zones.
 - **Power:** the system operates at a higher speed than in Standard mode to ensure airflow is increased.
 - **Standard (by default):** the system changes speed depending on the number of zones.
 - **Silence:** the system operates at a lower speed than in Standard mode to improve noise reduction.
 - **Minimum:** the system operates at minimum speed regardless of the number of zones.
 2. **In fancoil units 0-10V.** This allows you to set the minimum (1.5 V by default) and maximum (10 V by default) working voltage of the fan of the controlled AC unit, in 1 V steps. The minimum voltage will correspond to the desired minimum speed of the AC unit and the maximum voltage will correspond to the maximum speed. The average speed will correspond to the midpoint between the two.
- **Radio channel.** This allows you to enable/disable the system's wireless association channel.
- **Information.** *(Only for Airzone Think thermostats)* This allows you to display information about:
 - **Zone:** firmware, zone, association, actuator or communications status.
 - **System:** firmware, IAQ firmware, settings and information on system and installation controllers.
 - **Devices:** indicates the elements connected to the system.
 - **Webserver:** firmware, IP address, gateway, MAC and PIN.
- **Reset system.** *(Only available for Airzone Blueface zero master thermostats)* This allows you to reset the system by returning it to factory settings. To reconfigure the thermostats, go to the "Initial configuration" section.

¹ Parameters not available in Airzone Blueface zero thermostats

- **Centralized control.** This allows you to define whether or not your installation has a centralized controller. By default, it will be configured as deactivated.
- **BACnet¹.** (*Only in installations with AZX6BACNET*) This parameter shows the device ID, uplink port, IP address, subnet mask and gateway IP and allows you to modify them. Click on the desired value, modify the parameters and click on the option to confirm. The default values are:
 - Device ID: 1000
 - Port: 47808
 - IP address: DHCP
- **Protection mode¹.** (*Only for Airzone Cloud*) This allows you to disable the delay in the closing of the motorized elements.

¹ Parameters not available in Airzone Blueface zero thermostats

ZONE PARAMETERS

- **Associated outputs.** This displays and allows you to select the control outputs associated to the thermostat.
- **Thermostat settings*.** This allows you to set up a thermostat as Master or Zone.

**Note: It cannot be configured as Master if there is already another thermostat configured as such.*

- **Use mode¹.** This allows you to configure the thermostat for the system's different zones in Basic or Advanced mode. By default, it is set to Advanced. The parameters that can be controlled in Basic mode are:

- On/Off
- Set-point temperature
- Operation mode (only if this is the master thermostat)
- Fan speed

If you need to reset the thermostat to Advanced mode, access the Advanced settings menu and activate Advanced use mode.

- **Control stages.** *(Only available in installations with AZCE6OUTPUT8 modules)* This allows you to configure the heating and cooling stages in the selected zone or all zones in the system. The options to configure are:
 - **Air:** enables heating/cooling by air in the zone selected.
 - **Radiant (not available in cooling stages):** enables radiant heating in the zone selected.
 - **Combined (not available in cooling stages):** enables air and radiant heating in the selected zone and allows the user to select the heating stage desired in that zone: Air, Radiant or Combined (see Zone settings section on the Blueface zero thermostat, Heating stages).
 - **Off:** disables the heating/cooling stage in the zone selected.
- **Offset.** This allows you to correct the room temperature measured in the different zones or in all of them, due to deviations produced by sources of heat/cold nearby, with a correction factor between - 2.5 °C and 2.5 °C in steps of 0.5 °C. By default, it is set to 0 °C.
- **Reset thermostat.** *(Not available in remote zones)* This allows you to reset the thermostat by returning to the initial settings menu.

¹ Parameters not available in Airzone Blueface zero thermostats

Incidents

EN

In the case of Airzone Blueface zero and Think thermostats, a warning will appear on the display screen.

WARNINGS

Anti-freezing. This is displayed if the function is enabled.

Active window. Indicates that the air conditioning has been suspended in the zone due to an open window. Only available in systems that have enabled the control of windows.

DHW. Domestic hot water activated. If your system integrates DHW management control in its production unit and this is activated, this message will appear on your Blueface zero and the air conditioning in that zone will be suspended.

Low battery. Low battery warning.

Filter maintenance. This indicates that filter maintenance should be performed.

ERRORS

In the case of any of the following errors, please contact your installer:

Communication errors

- 1** Thermostat – Main control board
 - 8** Lite thermostat – Main control board
 - 9** Gateway – Airzone system
 - 10** BACnet gateway – Main control board
 - 11** Gateway – Indoor unit
 - 12** Webserver – Airzone system
 - 13** Control module of radiant elements – Main control board
 - 14** Expansion module – Main control board
 - 15** Consumption meter – Main control board
 - 17** Lutron gateway – Airzone system
 - C-02** Production control board – Main control board
 - C-09** Air to water gateway – Production control board
 - C-11** Air to water gateway – Air to water unit
- AC unit error** Anomaly in the AC unit

Other errors

- 5** Open circuit in temperature probe
- 6** Short circuit in temperature probe
- 16** Measuring error in consumption meter
- 19** Alarm jumper error

In the case of Airzone Lite thermostats, if the On/Off icon  blinks rapidly in red, it means communication with the main control board has been lost.

Error 1: Thermostat (wired) - Main control board

This issue does not allow the zone to be controlled. Check whether the error appears on all thermostats; if it does, check that the main control board is operating properly. To resolve this issue, make the following checks:

1. Status of the main control board: Check that the power supply is correct.
2. Status of the main control board: Correct operation of the Airzone connection bus LEDs.
3. Connections: Check that the polarity of the connections to the main control board and the thermostat is correct.
4. Wired: Check that the voltage between poles (A/-) and (B/-) is 1.8 VDC.
5. Restart the zone and reassociate it to the system:
 - Blueface zero thermostats: Press on the word Reset to restart the device. If the error persists, press and hold the icon and reset the thermostat. Carry out the initial configuration of the system.
 - Think thermostats: Press and hold on **AIRZONE** and perform the initial system configuration process.
6. Restart the system: If you restart the system, this error may appear on the thermostats due to the restart. This message should disappear in approximately 30 seconds once the restart has been completed.

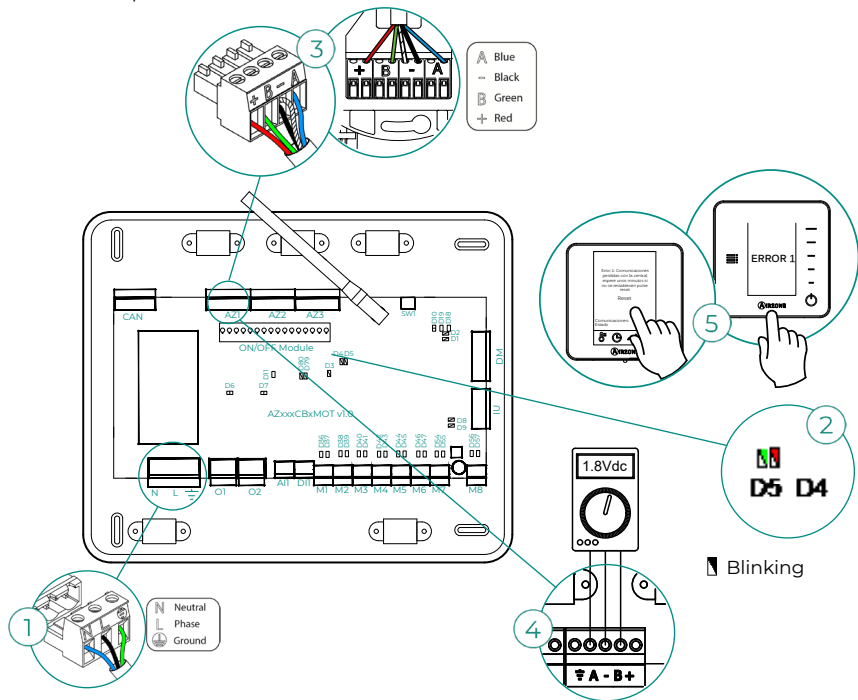

Error 1: Thermostat (wireless) - Main control board

This issue does not allow the zone to be controlled. Check whether the error appears on all thermostats; if it does, check that the main control board is operating properly. To resolve this issue, make the following checks:

1. Thermostat status: Check the thermostat's signal range from the main control board by checking the Information parameter (see the section System advanced settings, System parameters), or by bringing the thermostat closer to the main control board. If it re-establishes communication, it will be necessary to relocate the thermostat because it was not in signal range.
2. Status of the main control board: Check that the power supply is correct.
3. Status of the main control board: Check the correct functioning of the wireless communication LEDs.
4. Restart the zone and reassociate it to the system. To do this, press and hold on **AIRZONE** and perform the initial system configuration process. Remember that, in order to associate wireless devices, you should first open the wireless association channel, either through the SW1 button on the main control board or from any thermostat in the Radio channel parameter of the System advanced settings menu, Zone parameters.
5. Restart the system: If you restart the system, this error may appear on the thermostats due to the restart. This message should disappear in approximately 30 seconds once the restart has been completed.

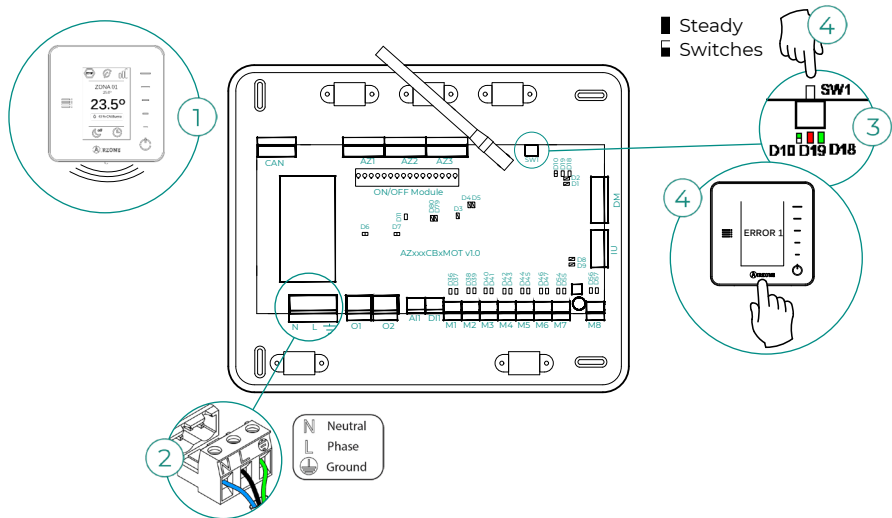

Error 5: Open circuit in temperature probe

The zone loses the room temperature measurement, leaving the zone unable to generate demand. In the event of such an incident, the device must be replaced or sent for repair.

Error 6: Short circuit in temperature probe

The zone loses the room temperature measurement, leaving the zone unable to generate demand. In the event of such an incident, the device must be replaced or sent for repair.

Error 8: Thermostat Lite (wired) - Main control board

The zone loses the room temperature measurement of an associated wired Lite thermostat, leaving the zone disabled and unable to generate demand. From your Blueface zero thermostat, check whether the Lite thermostat has lost communications. To resolve this issue, make the following checks:

1. Connections: Check that the polarity of the connections to the main control board and the sensor is correct.
2. Wired: Check that the voltage between poles (A /-) and (B /-) is 1.8 VDC.
3. Check whether the thermostat in question has the microswitch that corresponds to the associated zone selected. If not, activate it by pulling up the switch to the desired value.

Remember: Should it be necessary to change the zone number, first reset the thermostat and initiate the association sequence.

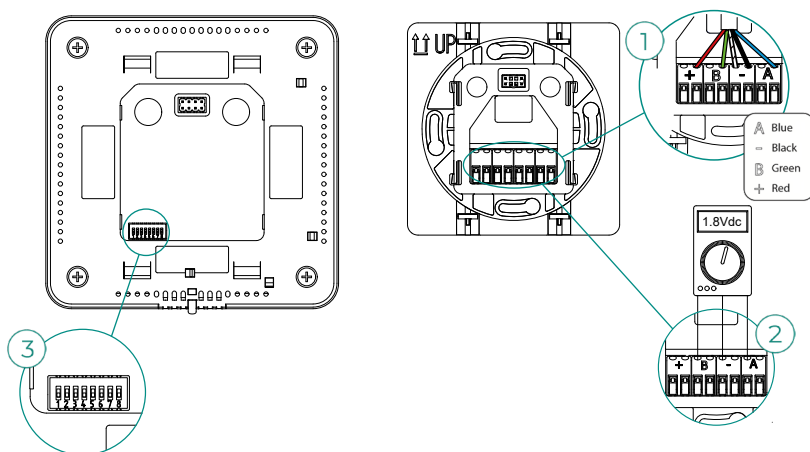

Error 8: Thermostat Lite (wireless) - Main control board

The zone loses the room temperature measurement of an associated wireless Lite thermostat, leaving the zone disabled and unable to generate demand. From your Blueface zero thermostat, check whether the Lite thermostat has lost communications. To resolve this issue, make the following checks:

1. Power supply: Check the battery's status and, if in doubt, replace it with a new battery.
2. Check whether the Lite thermostat in question has the microswitch that corresponds to the associated zone selected. If not, activate it by pulling up the switch to the desired value. Remember that, in order to associate wireless devices, you should first open the wireless association channel, either through the SW1 button on the main control board or from any thermostat in the Radio channel parameter of the System advanced settings menu, Zone parameters.

Remember: Should it be necessary to change the zone number, first reset the thermostat and initiate the association sequence.

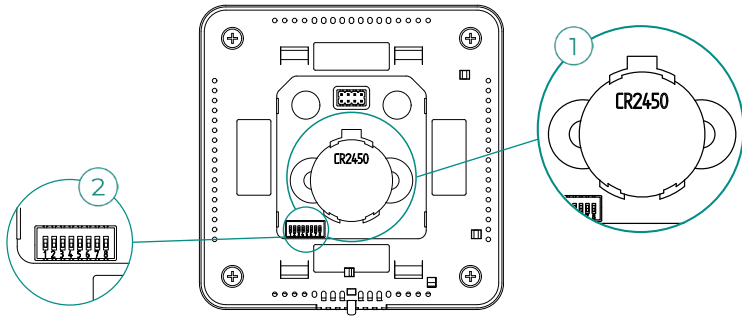

Error 9: Gateway - Airzone system

The system loses communication with the gateway and therefore with the AC unit. The system will open all its zones and disable control from the system's thermostats, thus allowing the AC unit to operate from the manufacturer's thermostat. To resolve this issue, make the following checks:

1. Check that the gateway is properly connected to the main control board's IU port.
2. If the gateway is a DIN rail format, check that the polarity of the connectors of the gateway and the main control board's IU port is correct.
3. Check that the status of the connected gateway's LEDs is correct. To do so, make use of the troubleshooting section or your gateway's technical fact sheet.

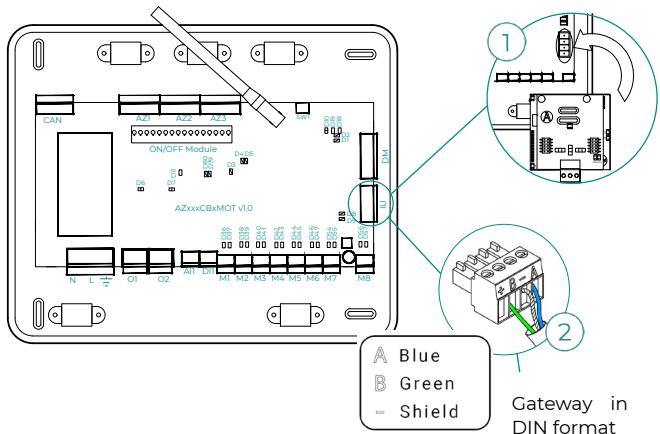

Error 10: BACnet gateway - Main control board

The system loses communication with the gateway. Check that the gateway is properly connected to the main control board's DM1 port.

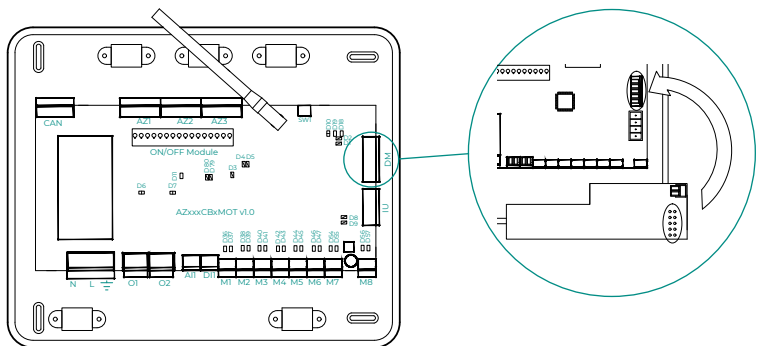

Error 11: Gateway - Indoor unit

The gateway loses communication with the AC unit. The system will open all its zones and disable control from the system's thermostats, thus allowing the AC unit to operate from the manufacturer's thermostat. To resolve this issue, make the following checks:

1. Check that the AC unit is powered. To do this, check that the AC unit's thermostat is switched on.
2. Check whether the AC unit operates properly independently of the system. To do so, disconnect the AC unit from the Airzone system and activate the unit from the AC unit's thermostat.
3. Connections: Check that the polarity of the connections to the gateway and indoor unit is correct. Consult your gateway's technical fact sheet.
4. Wired: In DIN rail gateways, check that the voltage between poles (A /-) and (B /-) is 1.8 VDC.
5. Check that the status of the connected gateway's LEDs is correct. To do so, make use of the troubleshooting section or your gateway's technical fact sheet.

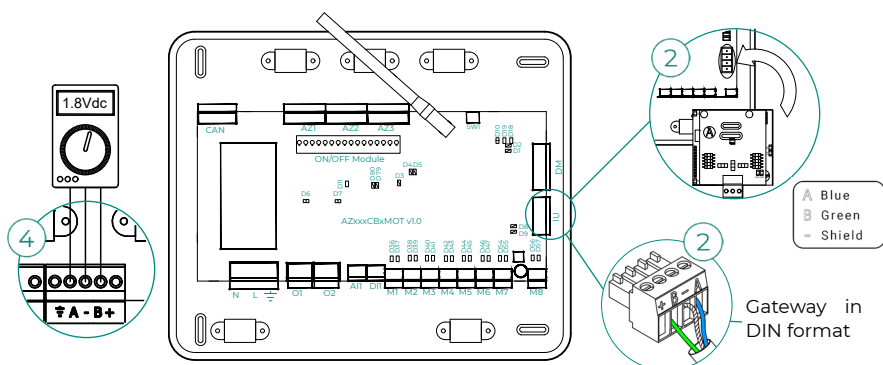

Error 12: Webserver - Airzone system

The system loses communication with the Webserver. To resolve this issue, make the following checks:

1. Check that the Webserver is properly connected to the main control board's automation port.
2. If the Webserver is a DIN rail format, check that the polarity of the connectors of the Webserver and the main control board's automation port is correct.
3. Check that the status of the Webserver's LEDs is correct. To do so, make use of your Webserver's self-diagnostics section or technical fact sheet.

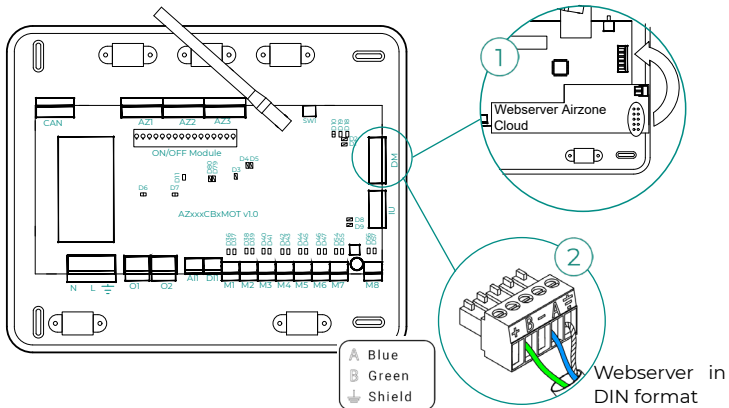

Error 13: Control module of radiant elements - Main control board

This issue does not allow the system to control the device. To resolve this issue, make the following checks:

1. Status of control module of radiant elements: Check that the power supply is correct.
2. Status of control module of radiant elements and the main control board: Correct operation of the Airzone connection bus LEDs (AZ).
3. Connections: Check that the polarity of the connections to the main control board and the control module of radiant elements is correct.
4. Wired: Check that the voltage between poles (A/-) and (B/-) is 1.8 VDC.

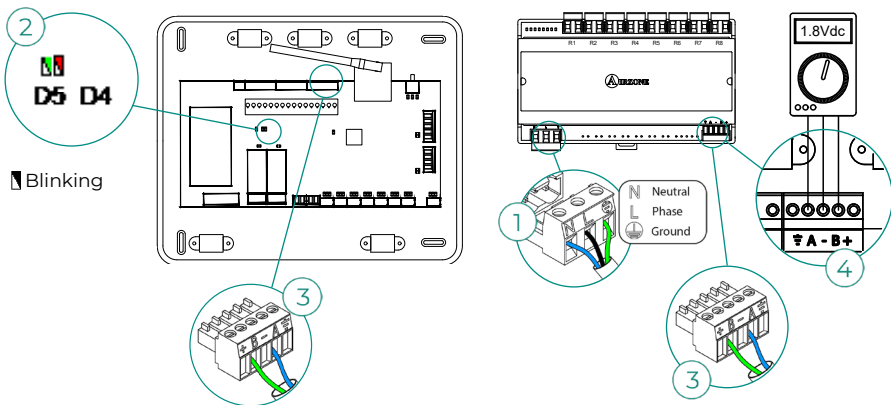

Error 15: Consumption meter - Main control board

This incident doesn't allow you to measure the AC unit's consumption. To resolve this issue, make the following checks:

1. Signal range of the device: Check the signal range of the meter with the main control board; to do so, check the LED  on the meter. If it is not in signal range (red LED), bring the meter closer to the main control board. If it recovers communications, it will be necessary to relocate it because it was out of range.
2. Status of the consumption meter: Check that the power supply is correct.

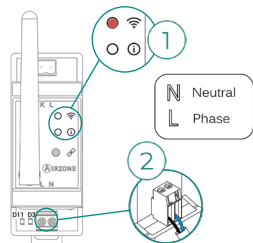

Error 16: Measuring error in consumption meter

This incident doesn't allow you to measure the AC unit's consumption. To resolve this issue, make the following checks:

Check that the ammeter clamp is properly connected to the AC unit wiring.

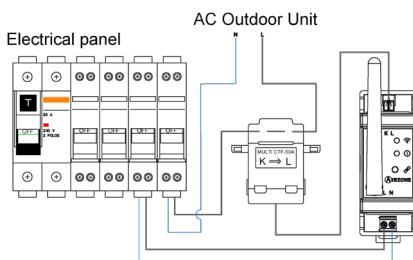

Error 17: Lutron gateway - Airzone system

The system loses communication with the gateway. Check that the gateway is properly connected to the main control board's DM1 port.

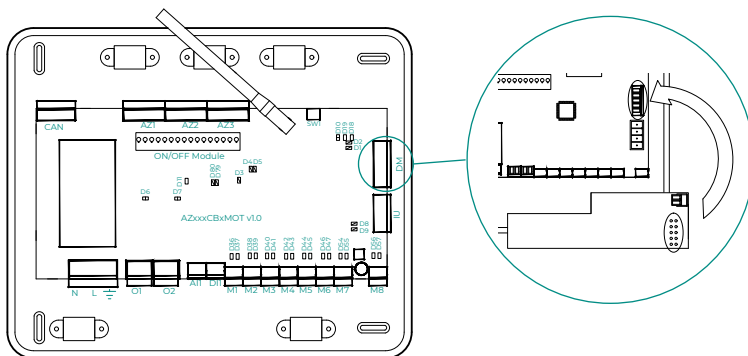

Error 19: Alarm jumper error

The system detects that the alarm jumper is not connected and forces it into Stop mode. Check to be sure that the alarm jumper is properly connected.

EN

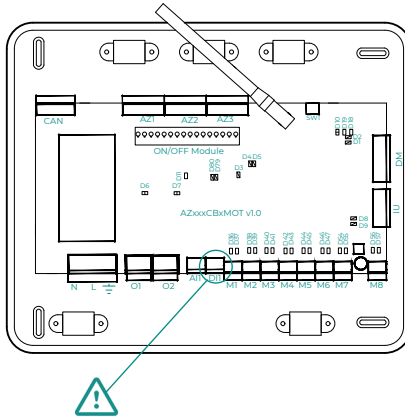

Error C-02: Production control board - Main control board

This issue does not allow the zone to be controlled. To resolve this issue, make the following checks:

1. CCP status: Check that the power supply is correct.
2. Status of the main control board: Check the correct functioning of the automation bus LEDs.
3. Connections: Check that the polarity of the connections to the CCP and the main control board are correct.

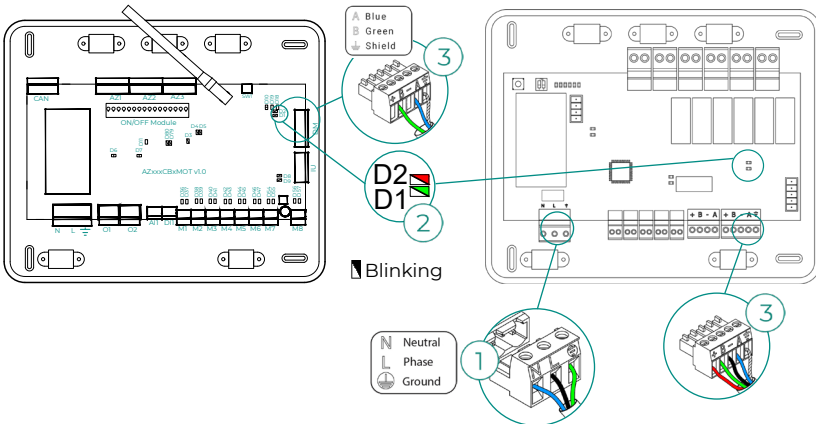

Error C-09: Air to water gateway - Production control board

The gateway loses communication with the air to water unit. Control of the system will be disabled, thus allowing the air to water unit to operate from the manufacturer's thermostat. To resolve this issue, make the following checks:

1. Check that the gateway is properly connected to the production control board's AC unit port.
2. Check that the status of the connected gateway's LEDs is correct. To do so, make use of the troubleshooting section or your gateway's technical fact sheet.

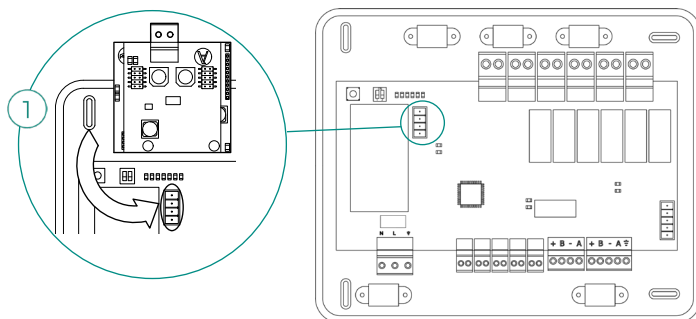

Error C-011: Air to water gateway - Air to water unit

The gateway loses communication with the air to water unit. Control of the system will be disabled, thus allowing the air to water unit to operate from the manufacturer's thermostat. To resolve this issue, check that the gateway is properly connected to the CCP's automation bus and the connection between it and the indoor unit. For more information on the connection between your gateway and the indoor unit, refer to your gateway's data sheet.

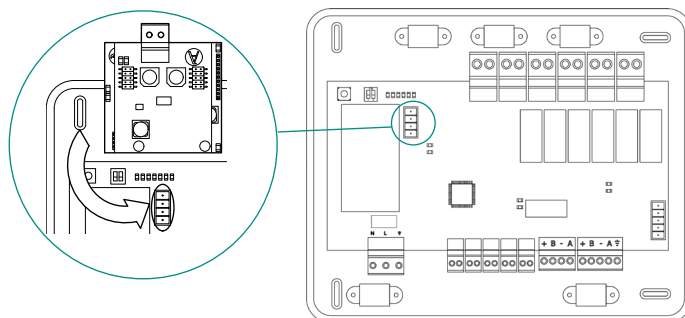

AC unit error: Anomaly in the AC unit

Consult the type of incident on the AC unit's thermostat and perform the repair actions indicated by the manufacturer.

Navigation Trees

AIRZONE BLUEFACE ZERO

Screensaver

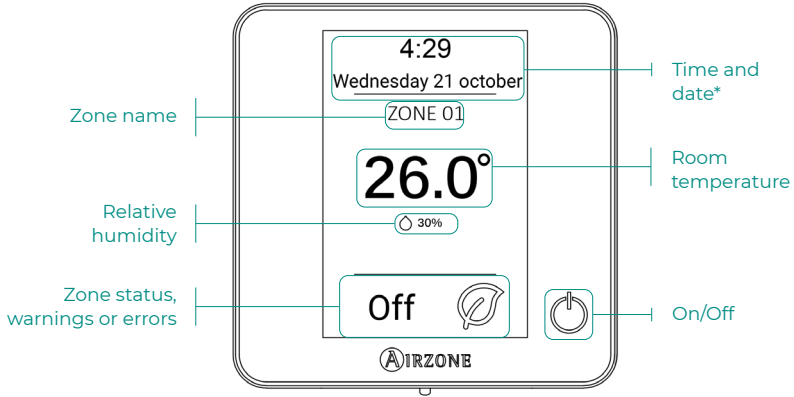

***Note:** If the system has Webserver, weather information will also appear.

Main screen

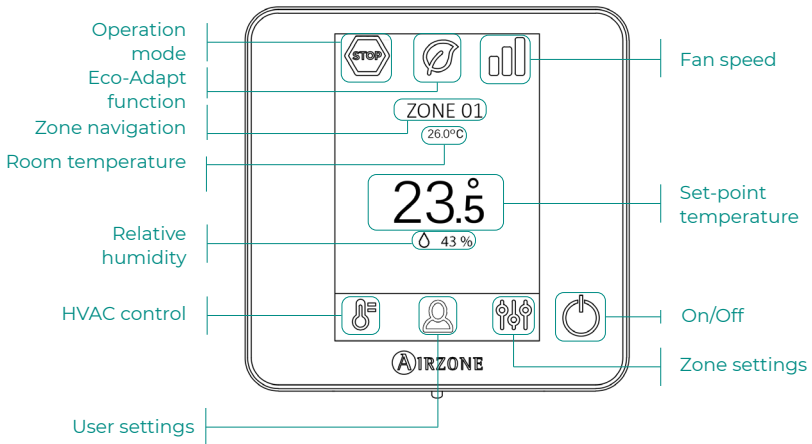

Screensaver

- Time and date*
- Current zone
- Room temp.*
- Relative humidity*
- Zone status
- Weather information

*Configurable values

Touch any place on the screen

Main screen

Operation mode

- Cooling
- Heating
- Dry
- Ventilation
- Stop

ECO-Adapt

- Off
- A
- A+
- A++

Fan speed

- Automatic
- High
- Medium
- Low

User settings

- Lang./Country
- Brightness
- Information

Current zone

- HVAC control

Room temp.

- ON/OFF

Set-point temp.

+Temp.
-Temp.

Zone settings

- Sleep mode
- Anti-freezing
- Grille angle**
- Control stages**
- Q-Adapt
- Lite settings

Relative humidity

Press and hold on the zone settings icon

Advanced settings

Zone

- Associated outputs
- Thermostat settings
- Control stages**
- Offset
- Reset thermostat

System

- System address**
- Radio channel
- Reset system
- Centralized control

** Available in function of the installation type and the system settings.

AIRZONE THINK

Screensaver

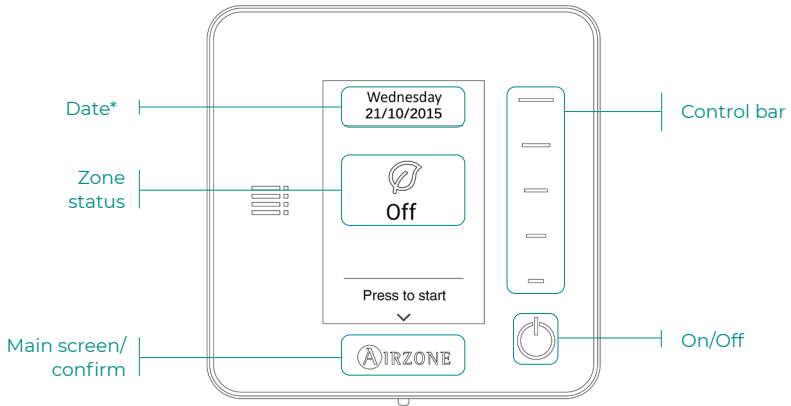

**Note: If the system has Webserver, weather information will also appear.*

Main screen

Access the main screen by pressing "Airzone" from the screensaver:

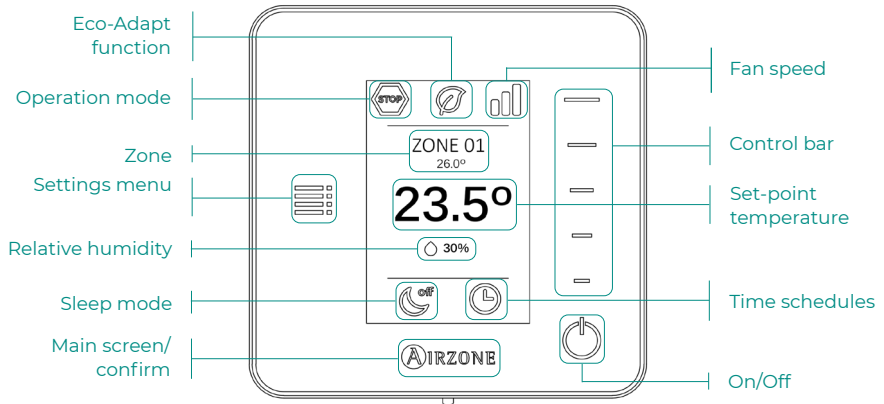

Screensaver

- Date*
- Current zone*
- Zone status
- Weather information*
- Airzone

**Depending on the devices connected* *Press on Airzone*

Main screen

INFORMATIVE ICONS

<p>Operation mode</p> <ul style="list-style-type: none"> Cooling Heating Dry Ventilation Stop 	<p>ECO-Adapt</p> <ul style="list-style-type: none"> Off A A+ A++ 	<p>Fan speed</p> <ul style="list-style-type: none"> Automatic High Medium Low 	<p>Relative humidity</p> <p> Sleep mode</p>
<p>Current zone</p>	<p>Room temp.</p>	<p>Set-point temp.</p> <p>+Temp.</p> <p>-Temp.</p>	<p> Time schedules</p>

CAPACITIVE BUTTONS

<p> On/Off</p>	<p>Airzone</p>	<p>Settings menu</p> <ul style="list-style-type: none"> Mode** Speed** Sleep mode Zone navigation 	<p>Control bar</p>
-----------------------	-----------------------	--	---------------------------

Press and hold twice on Airzone

Advanced settings

<u>Zone</u>	<u>System</u>
Associated outputs	System address**
Thermostat settings	Temperature range
Use mode	Combined stage**
Control stages**	Hysteresis Config.
Offset	Type of opening
Reset thermostat	Q-Adapt
	Relay settings
	Centralized control
	Return temperature
	Radio channel
	Information

*** Available in function of the installation type and the system settings*



airzonecontrol.com

Marie Curie, 21
29590 Málaga
Spain

v 600



CE

