

**UTP-RX08AH**  
**UTP-RX12AH**

## **INSTALLATION MANUAL**

RB UNIT

For authorized service personnel only.

English

## **INSTALLATIONSANLEITUNG**

KÄLTEMITTEL-ABZWEIGUNGS-GERÄT

Nur für autorisiertes Fachpersonal.

Deutsch

## **MANUEL D'INSTALLATION**

UNITÉ DE DÉRIVATION DE RÉFRIGÉRANT

Pour le personnel agréé uniquement.

Français

## **MANUAL DE INSTALACIÓN**

UNIDAD DE DERIVACIÓN DE REFRIGERANTE

Únicamente para personal de servicio autorizado.

Español

## **MANUALE DI INSTALLAZIONE**

UNITÀ REFRIGERANTE SECONDARIA

A uso esclusivo del personale tecnico autorizzato.

Italiano

## **ΕΓΧΕΙΡΙΔΙΟ ΕΓΚΑΤΑΣΤΑΣΗΣ**

ΜΟΝΑΔΑ ΔΙΑΚΛΑΔΩΣΗΣ ΨΥΚΤΙΚΟΎ

Μόνο για εξουσιοδοτημένο τεχνικό προσωπικό.

Ελληνικά

## **MANUAL DE INSTALAÇÃO**

UNIDADE DE DERIVAÇÃO DE REFRIGERANTE

Apenas para técnicos autorizados.

Português

## **РУКОВОДСТВО ПО УСТАНОВКЕ**

МОДУЛЬ ВЕТКИ ОХЛАЖДЕНИЯ

Только для авторизованного обслуживающего персонала.

Русский

## **MONTAJ KILAVUZU**

SOĞUTUCU DAĞITIM ÜNİTESİ

Yalnızca yetkili servis personeli için.

Türkçe

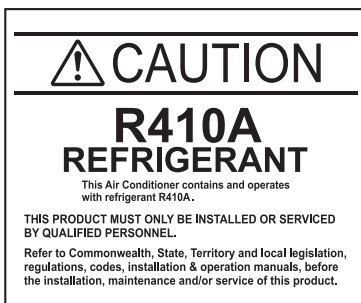

**FUJITSU GENERAL LIMITED**



[Original instructions]

**PART NO. 9366247067-02**

# INSTALLATION MANUAL

PART NO. 9366247067-02  
VRF system RB unit

## Contents

1. SAFETY PRECAUTIONS.....	1
2. ABOUT THIS PRODUCT .....	1
2.1. Precautions for using R410A refrigerant.....	1
2.2. Special tools for R410A.....	1
2.3. Accessories.....	2
2.4. Optional parts.....	2
3. CONNECTION SPECIFICATIONS.....	2
4. PIPING SPECIFICATIONS.....	2
5. INSTALLATION WORK .....	2
5.1. Selecting an installation location.....	2
5.2. Installation dimensions.....	3
5.3. Hanger bolt installation.....	4
5.4. Hanging metal fixtures.....	4
5.5. Installation of the unit.....	4
6. PIPE INSTALLATION .....	5
6.1. Pipe selection.....	5
6.2. Selecting the pipe material.....	6
6.3. Pipe connection.....	6
6.4. Installing heat insulation.....	6
7. ELECTRICAL WIRING.....	7
7.1. Safety precautions for electrical wiring.....	7
7.2. Electrical requirement.....	7
7.3. Wiring.....	7
8. FIELD SETTING.....	10
8.1. PC board layout.....	10
8.2. Address setting.....	11
8.3. Function setting.....	11
9. EXTERNAL INPUT.....	11
9.1. Input select.....	11
9.2. Cooling/heating priority function.....	12
10. MERGING 2 OR 4 BRANCHES.....	12
10.1. Connection specifications.....	12
10.2. Pipe installation (pipe selection).....	12
10.3. Electrical wiring.....	13
10.4. Field setting.....	14
11. TEST RUN.....	14
11.1. Test run using Outdoor unit (PC board).....	14
11.2. Test run using Remote Controller.....	14
12. CHECK LIST.....	14
13. INDICATOR LAMP STATUS.....	14

## 1. SAFETY PRECAUTIONS

- Be sure to read this Manual thoroughly before installation.
- The warnings and precautions indicated in this Manual contain important information pertaining to your safety. Be sure to observe them.
- Hand this Manual, together with the Operating Manual, to the customer. Request the customer to keep them on hand for future use, such as for relocating or repairing the unit.

 <b>WARNING</b>	This mark indicates procedures which, if improperly performed, might lead to the death or serious injury of the user.
Never touch electrical components immediately after the power supply has been turned off. Electrical shock may occur. After turning off the power, always wait 10 minutes or more before touching electrical components.	
Request your dealer or a professional installer to install this unit in accordance with this Installation Manual. An improperly installed unit can cause serious accidents such as water leakage, electric shock, or fire. If this unit is installed in disregard of the instructions in the Installation Manual, it will void the manufacturer's warranty.	
Do not turn ON the power until all work has been completed. Turning ON the power before the work is completed can cause serious accidents such as electric shock or fire.	
If refrigerant leaks while work is being carried out, ventilate the area. If the refrigerant comes in contact with a flame, it produces a toxic gas.	
Installation work must be performed in accordance with national wiring standards by authorized personnel only.	
During installation, make sure that the refrigerant pipe is attached firmly before you run the compressor. Do not operate the compressor under the condition of refrigerant piping not attached properly with 2-way or 3-way valve open. This may cause abnormal pressure in the refrigeration cycle that leads to breakage and even injury.	
When installing and relocating the air conditioner, do not mix gases other than the specified refrigerant (R410A) to enter the refrigerant cycle. If air or other gas enters the refrigerant cycle, the pressure inside the cycle will rise to an abnormally high value and cause breakage, injury, etc.	
Be sure to always use the parts accessories or the specified parts for installation. Failure to use the specified parts may cause the equipment to fail, water leakage, electric shock or fire.	
Install the equipment in a location that is out of reach of children.	
Be sure to check that there are no refrigerant leaks after installation is completed. If there is refrigerant gas leak indoors and comes into contact with an open flame from such sources as a fan heater, bunsen burner, or stove, it can generate toxic fumes.	
Do not turn OFF the breaker (or the disconnect switch) connected to the RB unit during operations except in an emergency. Doing so may cause a compressor malfunction. When turning OFF the RB unit power, first stop refrigerant system operations, and then turn OFF the breaker (or disconnect switch) connected to the RB unit.	

This product is not intended to be used by people (including children) with physical, sensory or mental disability, or persons lacking experience or knowledge unless they have been given by the through a person responsible for their safety, supervision or instruction concerning the use of the device.

 <b>CAUTION</b>	This mark indicates procedures which, if improperly performed, might possibly result in personal harm to the user, or damage to property.
Read carefully all security information before use or install the air conditioner.	
Do not attempt to install the air conditioner or a part of the air conditioner by yourself.	
This unit must be installed by qualified personnel with a capacity certificate for handling refrigerant fluids. Refer to regulation and laws in use on installation place.	
The installation must be carried out in compliance with regulations in force in the place of installation and the installation instructions of the manufacturer.	
This unit is part of a set constituting an air conditioner. It must not be installed alone or with non-authorized by the manufacturer.	
Always use a separate power supply line protected by a circuit breaker operating on all wires with a distance between contact of 3mm for this unit.	
The unit must be correctly grounded and the supply line must be equipped with a differential breaker in order to protect the persons.	
The units are not explosion proof and therefore should not be installed in explosive atmosphere.	
Do not turn on the power until all installation work is complete.	
This unit contains no user-serviceable parts. Always consult authorized service personnel to repairs.	
When moving, consult authorized service personnel for disconnection and installation of the unit.	
Children should be monitored to ensure they do not play with the device.	
It is not necessary to provide drainage for this unit.	
This equipment is for indoor use only.	

## 2. ABOUT THIS PRODUCT

### 2.1. Precautions for using R410A refrigerant

 <b>WARNING</b>	Do not introduce any substance other than the prescribed refrigerant into the refrigeration cycle. If air enters the refrigeration cycle, the pressure in the refrigeration cycle will become abnormally high and cause the piping to rupture.
If there is a refrigerant leakage, make sure that it does not exceed the concentration limit. If a refrigerant leakage exceeds the concentration limit, it can lead to accidents such as oxygen starvation.	
Do not touch refrigerant that has leaked from the refrigerant pipe connections or other area. Touching the refrigerant directly can cause frostbite.	
If a refrigerant leakage occurs during operation, immediately vacate the premises and thoroughly ventilate the area. If the refrigerant comes in contact with a flame, it produces a toxic gas.	







### 2.2. Special tools for R410A

 <b>WARNING</b>	To install a unit that uses the R410A refrigerant, use dedicated tools and piping materials that have been manufactured specifically for R410A use. Because the pressure of the R410A refrigerant is approximately 1.6 times higher than the R22, failure to use dedicated piping material or improper installation can cause rupture or injury. Furthermore, it can cause serious accidents such as water leakage, electric shock, or fire.
--	--

Tool name	Contents of change
Gauge manifold	Pressure is huge and cannot be measured with a conventional (R22) gauge. To prevent erroneous mixing of other refrigerants, the diameter of each port has been changed. It is recommended to use a gauge manifold with a high pressure display range -0.1 to 5.3 MPa and a low pressure display range -0.1 to 3.8 MPa.
Charging hose	To increase pressure resistance, the hose material and base size were changed.
Vacuum pump	A conventional (R22) vacuum pump can be used by installing a vacuum pump adapter. Be sure that the pump oil does not back flow into the system. Use one capable for vacuum suction of -100.7 kPa (5 Torr, -755 mmHg).
Gas leakage detector	Special gas leakage detector for HFC refrigerant R410A.

## 2.3. Accessories

Do not discard the accessories required for installation until the installation work is complete.

Name and shape	Q'ty	Application
Installation Manual 	1	This manual
Washer 	8	For suspending the RB unit from ceiling
Cable tie 	08AH: 9 12AH: 13	For mounting the transmission cable
Coupler heat insulation 	2	For strainer (Φ60)
Cabinet insulation (230×230 mm) 	1	For installation onto the cabinet.
Closed-end pipe A (large) 	3	For gas piping. (Φ12.7 [O.D.])
Closed-end pipe B (small) 	3	For liquid piping. (Φ6.35 [O.D.])

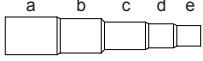
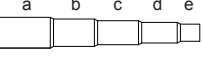
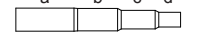
Reducer type	Q'ty
Reducer-A 	1
Reducer-B 	1
Reducer-C 	1

## 2.4. Optional parts

The following optional parts are available.

Description	Model No.	Application
External connect kit	UTY-XWZXZ6	For external input (Dry contact terminal / CNA01, CNA101, CNA201, CNA301)
	UTY-XWZXZB	For external input (Apply voltage terminal / CNA02, CNA102, CNA202, CNA302)
Separation tube kit	UTP-EX060A	To connect an indoor unit of 8.0 < Q (indoor unit capacity) ≤ 18.0 kW
	UTP-EX096A <sup>*1</sup>	To connect an indoor unit of 18.0 < Q (indoor unit capacity) ≤ 28.0 kW

\*1) To use UTY-EX096A, two additional sets of UTP-EX060A must be prepared.

## 3. CONNECTION SPECIFICATIONS

### Basic connection specifications

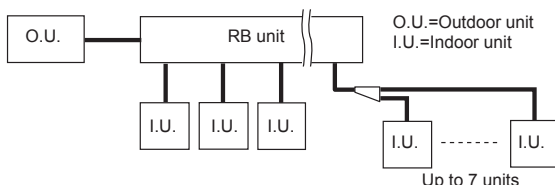

Table 1) Connection specifications

Maximum capacity of connectable indoor units (Q)	UTP-RX08AH	Q ≤ 72.0 kW
	UTP-RX12AH	Q ≤ 95.0 kW
Maximum capacity of connectable indoor units per branch (Q)	Capacity per branch	Q ≤ 8.0 kW
	To provide an indoor unit with a capacity exceeding 8.0 kW, refer to "10. MERGING 2 OR 4 BRANCHES".	
Maximum number of connectable indoor units per branch	Up to 7 units	

• The total capacity of the indoor units connected downstream is calculated as follows.

Example of calculation: In the case that the model codes of the connected indoor units are 04, 07, and 09.  
 $Q = 1.1 \text{ kW} + 2.2 \text{ kW} + 2.8 \text{ kW} = 6.1 \text{ kW}$   
 → Good

Table 2) Indoor unit model codes and model selection capacity

Model code	04	07	09	12	14	18	24	30
Indoor unit capacity (Kw)	1.1	2.2	2.8	3.6	4.0 4.5	5.6	7.1	8.0 9.0

Model code	34	36	45	54	60	72	90	96
Indoor unit capacity (Kw)	10.0	11.2	12.5	14.0	18.0	22.4	25.0	28.0

• For connectable indoor units, refer to the catalogue or the Design & Technical manual.  
 • You must connect the indoor units with 1 or more branches.

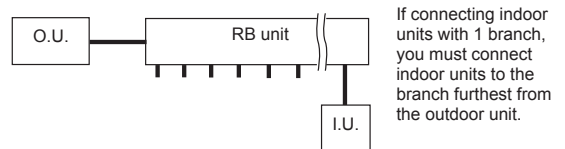

### Restrictions on installation related to serial connections

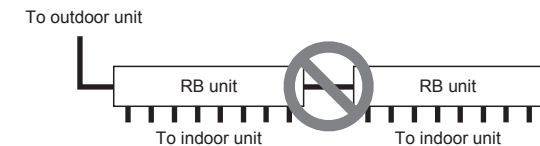

No more RB unit can be connected downstream of this RB unit (UTP-RX08AH/12AH).

## 4. PIPING SPECIFICATIONS

For details of piping specifications, refer to the outdoor unit installation manual.

## 5. INSTALLATION WORK

### 5.1. Selecting an installation location

#### ⚠ WARNING

Take into consideration whether the place you install the main unit can fully withstand its weight.  
 For hanger bolts, use embedded inserts or embedded foundation bolts in the case of new installation, and use a hole-in-anchor if already installed, and attach in a way so that the unit's weight can be supported.

#### ⚠ CAUTION

Do not install this unit in the following areas:

- Area with high salt content, such as at the seaside. It will deteriorate metal parts, causing the parts to fail or the unit to leak water.
- Area filled with mineral oil or containing a large amount of splashed oil or steam, such as a kitchen. It will deteriorate plastic parts, causing the parts to fail or the unit to leak water.
- Area that generates substances that adversely affect the equipment, such as sulfuric gas, chlorine gas, acid, or alkali. It will cause the copper pipes and brazed joints to corrode, which can cause refrigerant leakage.
- Area containing equipment that generates electromagnetic interference. It will cause the control system to malfunction, preventing the unit from operating normally.
- Area that can cause combustible gas to leak, contains suspended carbon fibers or flammable dust, or volatile inflammables such as paint thinner or gasoline. If gas leaks and settles around the unit, it can cause a fire.
- Area where small animals may live. It may cause failure, smoke or fire if small animals enter and touch internal electrical parts.
- Area where animals may urinate on the unit or ammonia may be generated.

**CAUTION**

Install this unit, power supply cable and transmission cable at least 1 m away from a television or radio receivers. The purpose of this is to prevent TV reception interference or radio noise. (Even if they are installed more than 1 m apart, you could still receive noise under some signal conditions.)

If children under 10 years old may approach the unit, take preventive measures so that they cannot reach the unit.

Select the place to install the product after taking into consideration the following conditions, and after obtaining approval from the customer.

- Install this unit in a location that has strong support and no vibrations.
- Install in a location that has enough space for this unit installation.
- Install in a well-ventilated area.
- Install in a location that is not exposed to high temperatures or humidity over a long periods.
- Do not install the unit in or near the areas where quietness is a priority (bedroom etc.). Refrigerant noise may be heard from the piping.

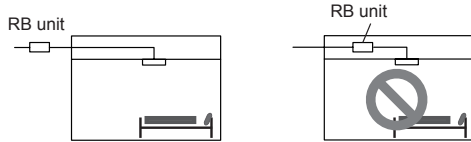

**5.2. Installation dimensions**

- Provide a service access for maintenance and inspection purposes as shown in the figure below. Be sure to prepare service access in control box side.
- It is not necessary to provide drainage for this unit.
- Install the RB unit without slant. (within ±2°).
- Use M8 or M10 for the hanger bolt size when hanging.

Product mass (kg)	
UTP-RX08AH	50.0
UTP-RX12AH	72.0

Example) UTP-RX12AH

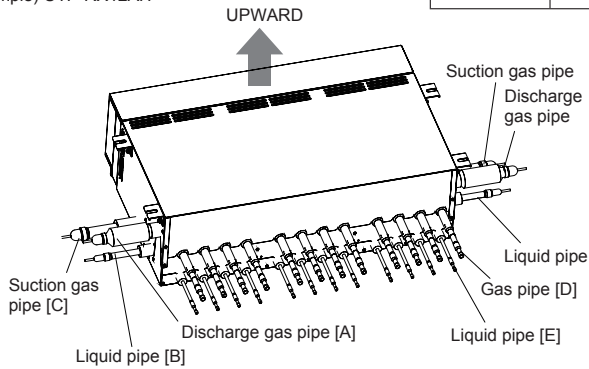

**5.2.1. Ceiling hanging**

Be sure to install so that the top side faces up.

■ UTP-RX12AH

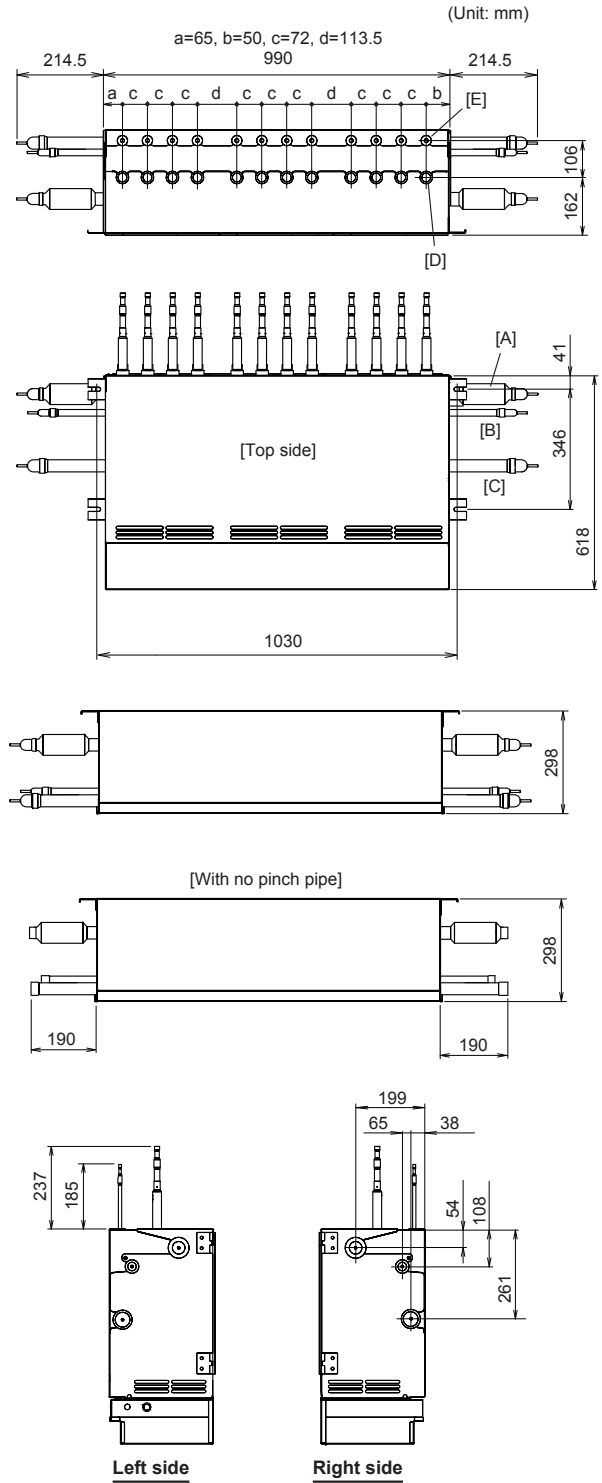

■ UTP-RX08AH

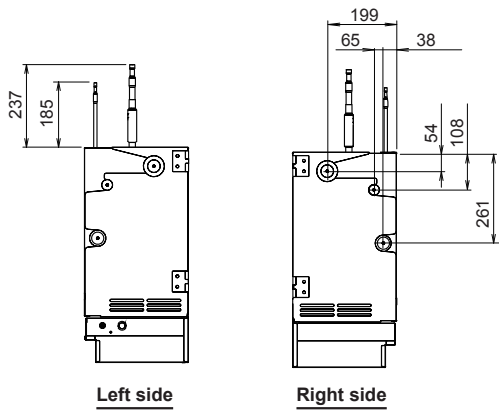
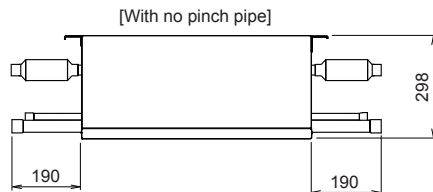
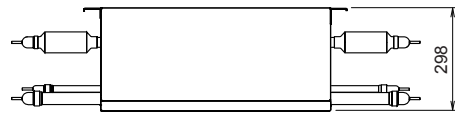
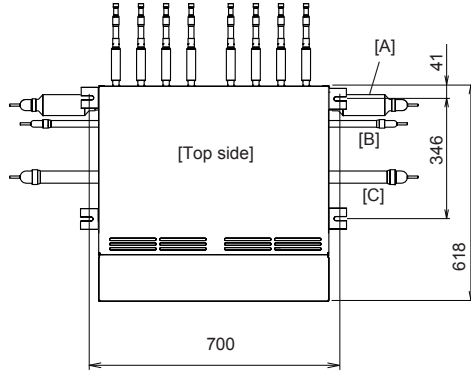
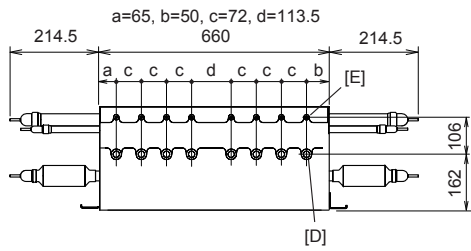

Left side

Right side

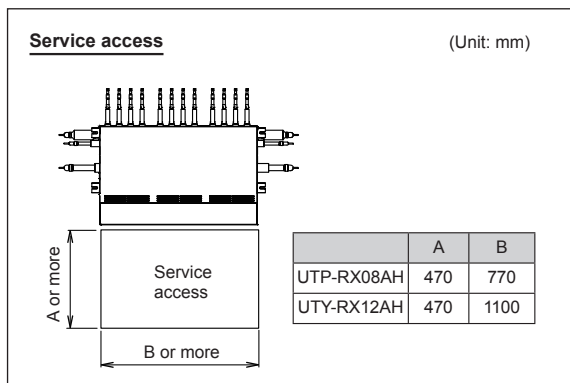

**Installation limit**

(Unit: mm)

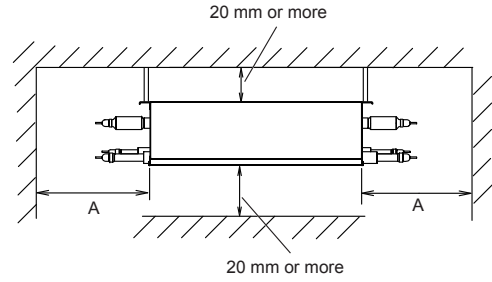

With piping connection: A=500 mm or more  
Without piping connection: A=280 mm or more

**5.3. Hanger bolt installation**

**WARNING**

Take into consideration whether the place you install the main unit can fully withstand its weight, and, if necessary, install a hanger bolt after reinforcing with a beam.

Use a M8 or M10 size hanger bolt.

**5.4. Hanging metal fixtures**

Support the connected piping within 1 m in front of and behind the main unit using hanging metal fixtures. If you place excessive weight on the main units hanging metal fixture, the unit may fall off.

**5.5. Installation of the unit**

**WARNING**

Perform installation in a location which can properly withstand the weight of the unit. Failure to install in a faulty installation may cause the equipment to fail, water leakage, electric shock or fire.

During installation, secure the hanger bolt so it does not come off.

**CAUTION**

Be sure to provide adequate maintenance space when installing the unit above the ceiling. (Refer to the installation restrictions contained in "5.2. Installation dimensions".)

**5.5.1. Removing the pinch pipe**

Melt the brazing filler metal on connecting part using a torch and remove the pinch pipe.

■ **If using the R-side**

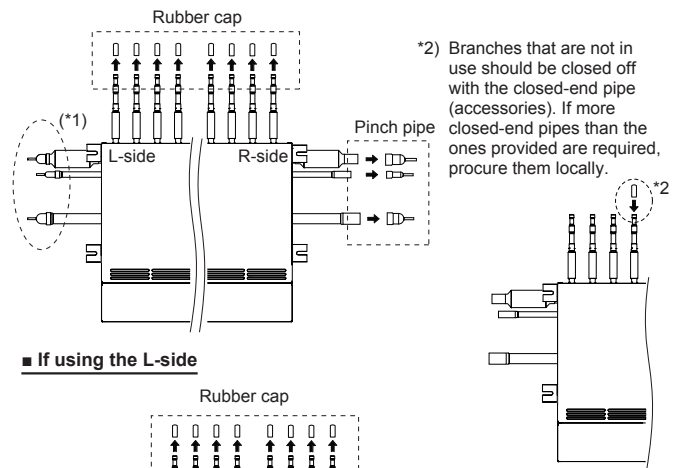

■ **If using the L-side**

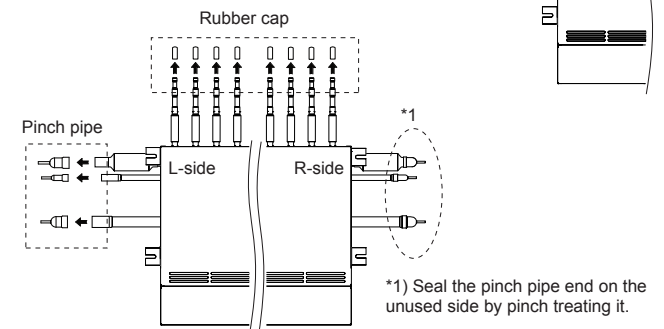

### 5.5.2. Fix the unit (When hanging from the ceiling)

- Attach the hanger to the hanger bolts as shown in the overview diagram below. (in 4 places)
- After checking that the equipment is horizontal, firmly fixed in place with the nuts (locally purchased) and washers (accessories).

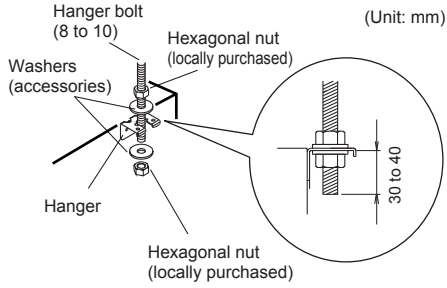

## 6. PIPE INSTALLATION

### 6.1. Pipe selection

(1) Select the piping to connect to the RB unit.

Type A) If connecting 1 indoor unit downstream of the RB unit

Select the connection pipe from Table 1, based on the total capacity of indoor units connected downstream.

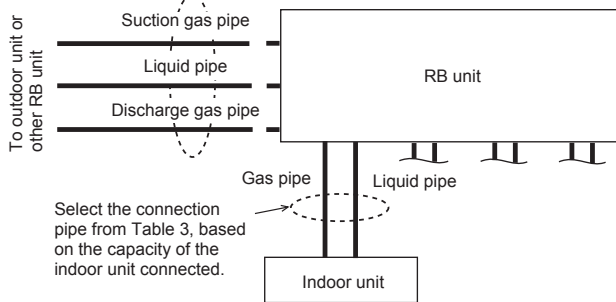

Type B) If connecting 2 or more indoor units downstream of the RB unit

Select the connection pipe from Table 1, based on the total capacity of indoor units connected downstream.

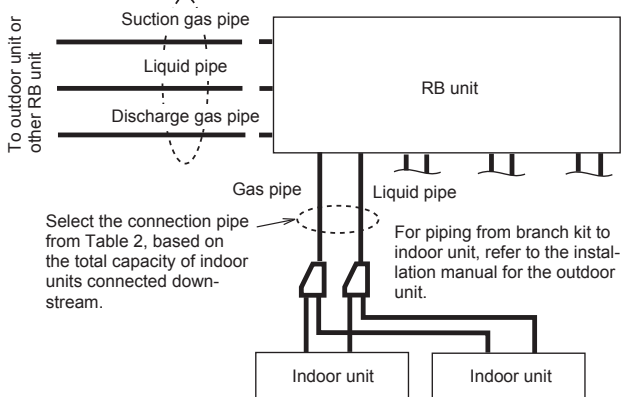

(2) If the size of the selected pipe is different from Table 4, use reducers (accessories) to make the diameters match.

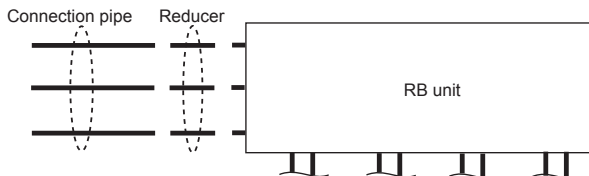

Table 1) Indoor unit total capacity and RB unit upstream side connection pipe sizes

Total capacity of indoor unit (kW)	Upstream of RB unit Outside diameter [mm(in)]		
	Liquid pipe	Discharge gas pipe	Suction gas pipe
1.1 to 11.1	ø9.52 (3/8") + Reducer	ø12.70 (1/2") + Reducer	ø15.88 (5/8") + Reducer
11.2 to 13.9	ø9.52 (3/8") + Reducer	ø12.70 (1/2") + Reducer	ø19.05 (3/4") + Reducer
14.0 to 22.3	ø12.70 (1/2") + Reducer	ø15.88 (5/8") + Reducer	ø22.22 (7/8") + Reducer
22.4 to 28.0	ø12.70 (1/2") + Reducer	ø19.05 (3/4") + Reducer	ø22.22 (7/8") + Reducer
28.1 to 44.7	ø12.70 (1/2") + Reducer	ø19.05 (3/4") + Reducer	ø28.58 (1-1/8") + Reducer
44.8 to 46.9	ø15.88 (5/8") + Reducer	ø19.05 (3/4") + Reducer	ø28.58 (1-1/8") + Reducer
47.0 to 56.0	ø15.88 (5/8") + Reducer	ø22.22 (7/8") + Reducer	ø28.58 (1-1/8") + Reducer
56.1 to 80.0	ø15.88 (5/8") + Reducer	ø28.58 (1-1/8")	ø34.92 (1-3/8")
80.1 to 95.0	ø19.05 (3/4")	ø28.58 (1-1/8")	ø34.92 (1-3/8")

• If there is a plan or possibility of adding indoor units in the future, select a pipe diameter that can support the increased connected capacity.

Table 2) Indoor unit total capacity and RB unit downstream side connection pipe sizes

Total capacity of indoor unit (kW)	Downstream of RB unit Outside diameter [mm(in)]	
	Gas pipe	Liquid pipe
2.2 to 8.0	ø15.88 (5/8")	ø9.52 (3/8")

• To make sure that the piping diameters match, cut the RB unit outlet branch first before connecting it to the mating pipe.

Table 3) Indoor unit capacity and connection pipe sizes

Indoor unit capacity (kW)	Downstream of RB unit Outside diameter [mm(in)]	
	Gas pipe	Liquid pipe
1.1, 2.2, 2.8, 3.6, 4.0, 4.5	ø12.70 (1/2")	ø6.35 (1/4")
5.6, 7.1, 8.0	ø15.88 (5/8") *1	ø9.52 (3/8") *1
Over 8.0	To connect an indoor unit with a capacity exceeding 8.0 kW, an optionally available separation tube kit must be used to merge 2 or 4 outlet pipe branches. For more detail, refer to the separation tube kit installation manual.	

\*1) To make sure that the piping diameters match, cut the RB unit outlet branch first before connecting it to the mating pipe.

Table 4) RB unit pipe size

Outdoor unit side Outside diameter [mm(in)]			Indoor unit side Outside diameter [mm(in)]	
Suction gas pipe	Discharge gas pipe	Liquid pipe	Gas pipe	Liquid pipe
ø34.92 (1-3/8")	ø28.58 (1-1/8")	ø19.05 (3/4")	Φ12.7 (1/2")	Φ6.35 (1/4")

(3) Indoor unit model codes and model selection capacity

Model code	04	07	09	12	14	18	24	30
Indoor unit capacity (Kw)	1.1	2.2	2.8	3.6	4.0 4.5	5.6	7.1	8.0 9.0

Model code	34	36	45	54	60	72	90	96
Indoor unit capacity (Kw)	10.0	11.2	12.5	14.0	18.0	22.4	25.0	28.0

**■ Cut the indoor side pipe of the RB unit with a pipe cutter.**

Liquid pipe :  $\phi 6.35(1/4") \rightarrow \phi 9.52(3/8")$   
 Gas pipe :  $\phi 12.7(1/2") \rightarrow \phi 15.88(5/8")$

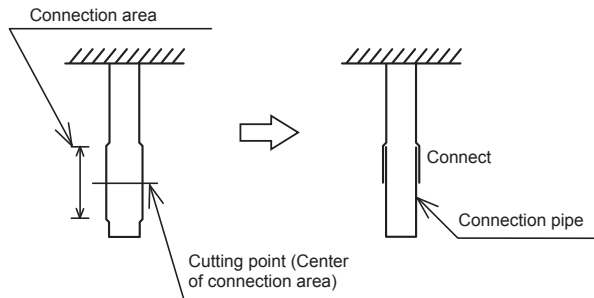

NOTE: Insert the connection pipe firmly until it touches the RB unit pipe.

**CAUTION**

- Use a pipe cutter to cut a pipe. When removing burrs after pipe cutting, make sure that loose particles do not get into the pipe.

**6.2. Selecting the pipe material**

**Copper pipes**

It is necessary to use seamless copper pipes and it is desirable that the amount of residual oil is less than 40 mg/10 m. Do not use copper pipes having a collapsed, deformed or discolored portion (especially on the interior surface). Otherwise, the expansion valve or capillary tube may become blocked with contaminants. As an air conditioner using R410A incurs pressure higher than when using conventional refrigerant (R22), it is necessary to choose adequate materials. Thicknesses of copper pipes used with R410A are as shown in the table. Never use copper pipes thinner than that in the table even when it is available on the market.

**Thicknesses of Annealed Copper Pipes (R410A)**

Pipe outside diameter [mm (in)]	Thickness [mm] *1	Material
$\phi 6.35 (1/4")$	0.80	COPPER JIS H3300 C1220T-O or equivalent (Allowable tensile stress $\geq 33 (N/mm^2)$ )
$\phi 9.52 (3/8")$	0.80	
$\phi 12.70 (1/2")$	0.80	
$\phi 15.88 (5/8")$	1.00	
$\phi 19.05 (3/4")$	1.20	COPPER JIS H3300 C1220T-H or equivalent (Allowable tensile stress $\geq 61 (N/mm^2)$ )
$\phi 22.22 (7/8")$	1.00	
$\phi 28.58 (1-1/8")$	1.00	
$\phi 34.92 (1-3/8")$	1.20	

\*1) Endurance pressure of the pipes 4.2MPa

**6.3. Pipe connection**

**6.3.1. Brazing**

**CAUTION**

If air or different type of refrigerant enters the refrigeration cycle, the internal pressure in the refrigeration cycle will become abnormally high and prevent the unit from exerting its full performance.

Apply nitrogen gas while brazing the pipes.  
 Nitrogen gas pressure: 0.02 MPa  
 (= sufficient pressure to be felt on the back of your hand or more)

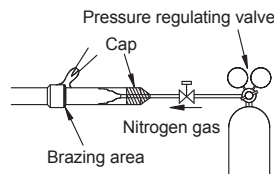

If a pipe is brazed without applying nitrogen gas, it will create an oxidation film. This can degrade performance or damage the parts in the unit (such as the compressor or valves).

Do not use flux to braze pipes. If the flux is the chlorine type, it will cause the pipes to corrode. In addition, if the flux contains fluoride, it will affect the refrigerant piping system due to deterioration of refrigerant oil.

For brazing material, use phosphor copper that does not require flux.

**6.3.2. Bending pipes**

The pipes are shaped by your hands. Be careful not to collapse them. Do not bend the pipes in an angle more than 90°. When pipes are repeatedly bent or stretched, the material will harden, making it difficult to bend or stretch them any more. Do not bend or stretch the pipes more than 3 times.

**CAUTION**

To prevent breaking of the pipe, avoid sharp bends. Bend the pipe with a radius of curvature of 100 mm or over.  
 If the pipe is bent repeatedly at the same place, it will break.

**6.3.3. Pipe connection**

The pipe can be connected by brazing

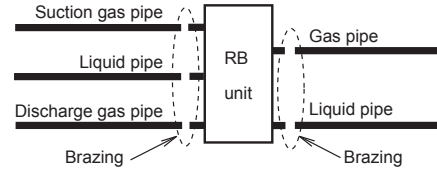

**6.4. Installing heat insulation**

**CAUTION**

Insulate the suction gas pipe, discharge gas pipe, liquid pipe, and gas pipe with heat insulation.

Use heat insulation with heat resistance above 120 °C. In addition, if the humidity level at the installation location of the refrigerant piping is expected to exceed 70%, install heat insulation around the refrigerant piping. If the expected humidity level is 70-80%, use heat insulation that is 15 mm or thicker and if the expected humidity exceeds 80%, use heat insulation that is 20 mm or thicker. If heat insulation is used that is not as thick as specified, condensation may form on the surface of the insulation. In addition, at 20 °C, use heat insulation with heat conductivity of 0.045 W/(m·K) or less.

**6.4.1. Piping insulation**

- (1) After the sealing test is complete, carry out insulation work.
- (2) Insulate all pipes and piping connection parts so that there is no gap in it.
- (3) Firmly connect the terminal part (a) so that no air comes in or out.
- (4) Do not squeeze the cable ties excessively so as to ensure that the insulation material is thick.

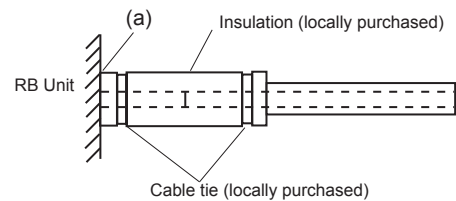

- Wind the coupler heat insulation (accessories) around the strainer section of the discharge gas piping.

**6.4.2. Installing cabinet insulation**

If the relative humidity of the area may rise above 80%, install cabinet insulation (accessories) in the following location:

(Unit: mm)

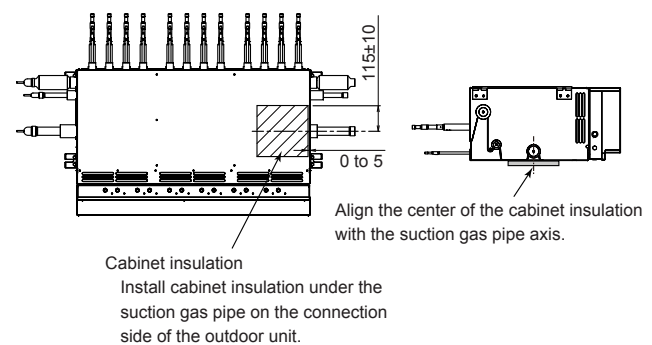

## 7. ELECTRICAL WIRING

### 7.1. Safety precautions for electrical wiring

 <b>WARNING</b>
Electrical work must be performed in accordance with this Manual by a person certified under the national or regional regulations. Be sure to use a dedicated circuit for the unit. An insufficient power supply circuit or improperly performed electrical work can cause serious accidents such as electric shock or fire.
Before starting work, check that power is not being supplied to the RB unit, indoor unit and outdoor unit.
For wiring, use the prescribed type of cables, connect them securely, making sure that there are no external forces of the cables applied to the terminal connections. Improperly connected or secured cables can cause serious accidents such as overheating the terminals, electric shock, or fire.
Securely install the electrical box cover on the unit. An improperly installed electrical box cover can cause serious accidents such as electric shock or fire through exposure to dust or water.
Use the included connection cables and power cables or ones specified by the manufacturer. Improper connections, insufficient insulation, or exceeding the allowable current can cause electric shock or fire.
Do not modify the power cables, use extension cables, or use any branches in the wiring. Improper connections, insufficient insulation, or exceeding the allowable current can cause electric shock or fire.
Match the terminal block numbers and connection cable colors with those of the indoor unit or outdoor unit. Erroneous wiring may cause burning of the electric parts.
Securely connect the connection cables to the terminal board. In addition, secure the cables with wiring holders. Improper connections, either in the wiring or at the ends of the wiring, can cause a malfunction, electric shock, or fire.
Always fasten the outside covering of the connection cable with the cable clamp. (If the insulator is chafed, electric discharge may occur.)
Install an earth leakage breaker. In addition, install the earth leakage breaker so that the entire AC main power supply is cut off at the same time. Otherwise, electric shock or fire could result.
Always connect the earth (ground) cable. Improper earthing (grounding) work can cause electric shocks.
Perform wiring work in accordance with standards so that the air conditioner can be operated safely and positively.
If the supply cable is damaged, it must be replaced by the manufacturer, its service agent or similarly qualified persons in order to avoid a hazard.

 <b>CAUTION</b>
Earth (Ground) the unit. Do not connect the earth (ground) cable to a gas pipe, water pipe, lightning rod, or a telephone earth (ground) cable. Improper earthing (grounding) may cause electric shock.
Do not connect power supply cables to the transmission terminals, as this will damage the product.
Never bundle the power supply cable and transmission cable, together. Separate these cable by 50 mm or more. Bundling these cables together will cause miss operation or breakdown.
When handling PC board, static electricity charged in the body may cause malfunction of the PC board. Follow the cautions below: <ul style="list-style-type: none"> <li>Establish an earth (ground) for the RB units, indoor units, outdoor units and peripheral devices.</li> <li>Cut power (breaker) off.</li> <li>Touch metal part of the RB units, indoor units and outdoor units for more than 10 seconds to discharge static electricity charged in the body.</li> <li>Do not touch terminals of parts and patterns implemented on PC board.</li> </ul>

### 7.2. Electrical requirement

<b>Voltage rating</b>	230 V
<b>Operating range</b>	198 to 264 V

- Select the power cable type and size in accordance with relevant local and national regulations.
- Specifications for local wiring power cord and branch wiring are in compliance with local code.
- Max. wire length: Set a length so that the voltage drop is less than 2%. Increase the wire diameter when the wire length is long.

Breaker should be installed at every refrigerant system. Do not use a breaker in a different refrigerant system.

Refer to the table for the breaker specifications of each installation condition. Perform the power crossover wiring within the range of the same refrigerant system. When the crossover wiring is done, make a connection for RB units to satisfy conditions A and B below.

#### A. Current breaker requirements

Model	MCA	MFA
UTP-RX08AH	1.04 A	20 A
UTP-RX12AH	1.56 A	20 A

MCA: Minimum Circuit Ampacity

MFA: Maximum Fuse Ampacity

When the power crossover wiring is done, make it so that the total of the MCA of the connected RB units and indoor units does not exceed the 15 A. For indoor unit MCA, refer to the indoor unit installation manual.

If the capacity of connected RB units and indoor units exceeds the upper limit, either add breakers or use a breaker with a greater capacity.

#### B. Earth leakage breaker requirements

Breaker capacity	Connectable RB units and indoor units
30 mA, 0.1 sec or less	44 or less *
100 mA, 0.1 sec or less	45 to 148

\* If the total number of units connected to the breaker exceeds 44, either add a 30mA breaker, or use breakers with a greater capacity.

#### 7.2.1. Cable specifications

Follow the specifications below for the power supply and transmission cable.

	Recommended cable size (mm <sup>2</sup> )	Cable type	Remark
Power supply cable	2.5	Type60245 IEC57 or equivalent	1ø 50 Hz 198 to 264 V 2 Cable + earth (ground)
Transmission cable	0.33	LONWORKS compatible cable	22 AWG LEVEL 4 (NEMA) non-polar 2 core, twisted pair solid core diameter 0.65 mm

### 7.3. Wiring

#### 7.3.1. Power supply cable

Keep the ground cable longer than the other cables.

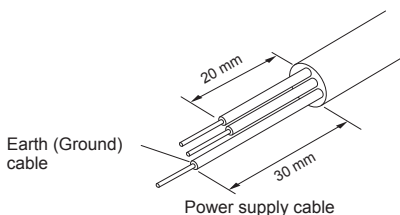

- Use ring terminals with insulating sleeves as shown in the figure below to connect to the terminal block.
- Securely clamp the ring terminals to the cables using an appropriate tool so that the cables do not come loose.
- Use the specified cables, connect them securely, and fasten them so that there is no stress placed on the terminals.



- (4) Use an appropriate screwdriver to tighten the terminal screws.  
Do not use a screwdriver that is too small, otherwise, the screw heads may be damaged and prevent the screws from being properly tightened.
- (5) Do not tighten the terminal screws too much, otherwise, the screws may break.
- (6) See the table for the terminal screw tightening torques.
- (7) Please do not fix 2 power supply cables with 1 screw.

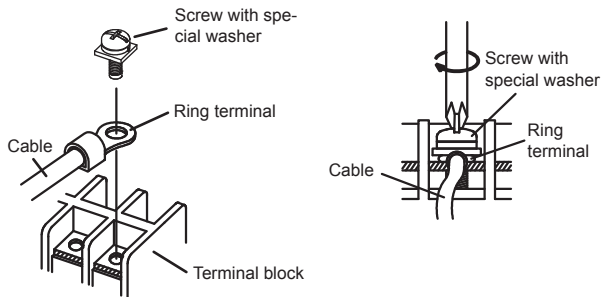
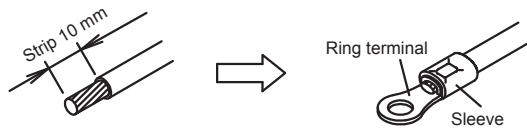

**⚠ WARNING**

Use ring terminals and tighten the terminal screws to the specified torques, otherwise, abnormal overheating may be produced and possibly cause heavy damage inside the unit.

**Tightening torque**

M4 screw (Power supply / L, N, GND)	1.2 to 1.8 N·m (12 to 18 kgf·cm)
--	-------------------------------------

**7.3.2. Transmission cable**

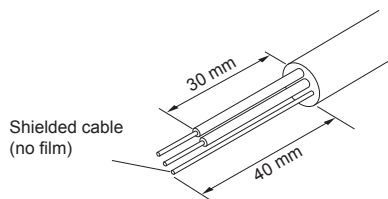

**GOOD**

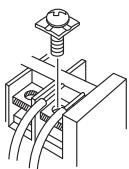

**PROHIBITED**

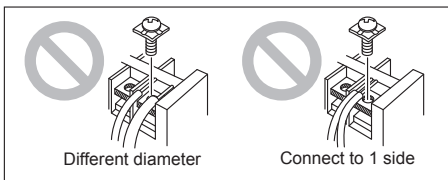

**⚠ WARNING**

Tighten the terminal screws to the specified torques, otherwise, abnormal overheating may be produced and possibly cause heavy damage inside the unit.

**Tightening torque**

M3 screw (Transmission / X1, X2)	0.5 to 0.6 N·m (5 to 6 kgf·cm)
-------------------------------------	-----------------------------------

**⚠ CAUTION**

To peel the film from the lead cable, use a dedicated tool that will not damage the conductor cable.

When installing a screw on the terminal block, do not cut the cable by overtightening the screw. On the other hand, an under tightened screw can cause faulty contact, which will lead to a communication failure.

### 7.3.3 Wiring method

The wiring example for RB units, outdoor units and indoor units is shown in the figure.

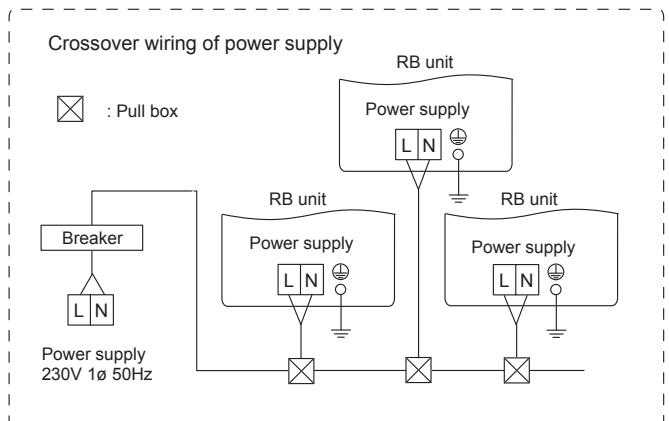
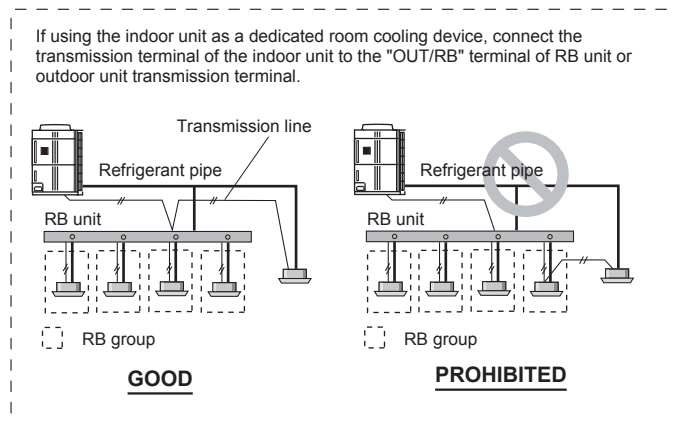
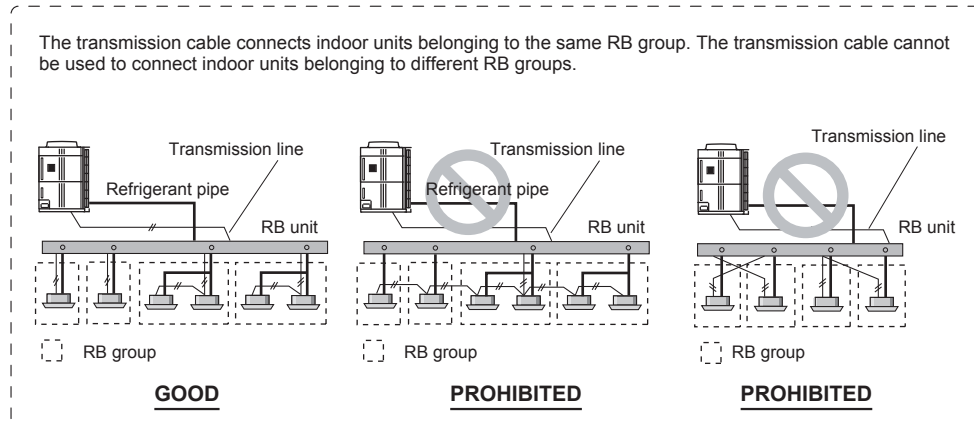
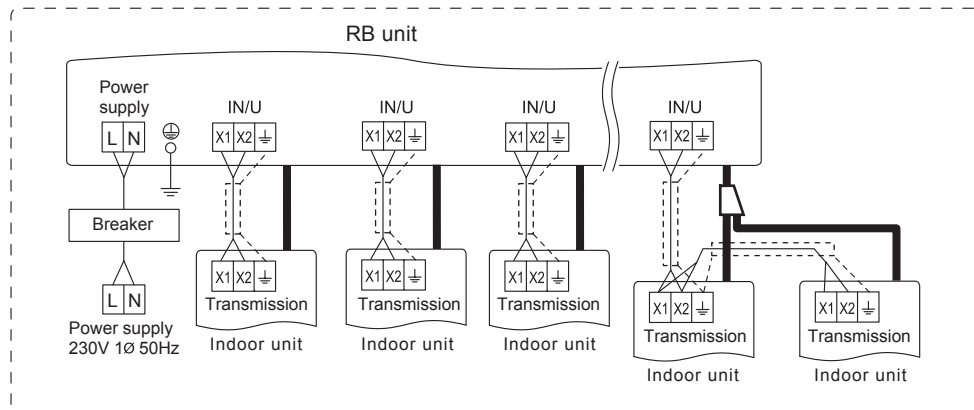
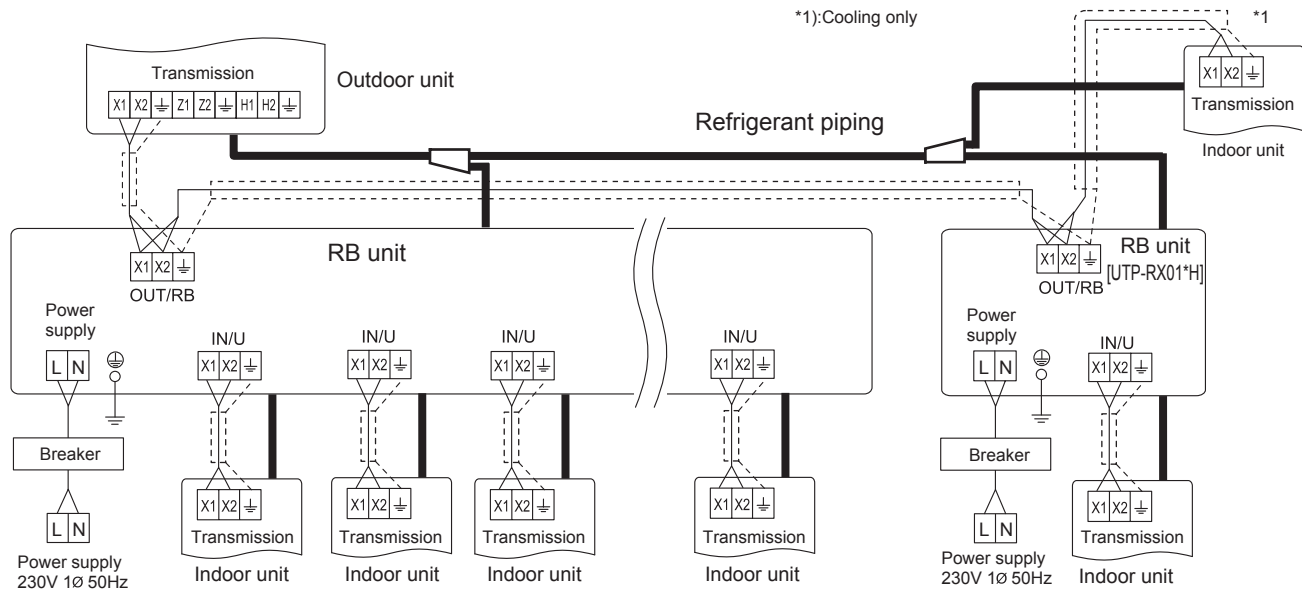

### 7.3.4. Work procedure

- (1) Remove the control box cover. (4 screws)

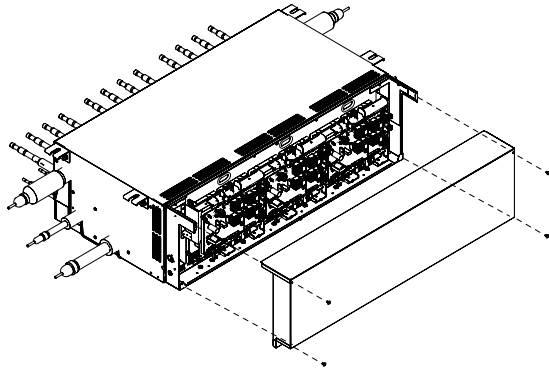

- (2) Connect the transmission cable to the transmission cable terminal.
- (3) Firmly attach the transmission cables using the accessory cable ties. RX08AH : Up to 9 locations, RX12AH : Up to 13 locations
- (4) Connect the power supply cable to the power supply cable terminal.
- (5) Firmly fix the power supply cable clamp in place.

Example) In the case of RX12AH:

Transmission cable  
(To indoor unit)

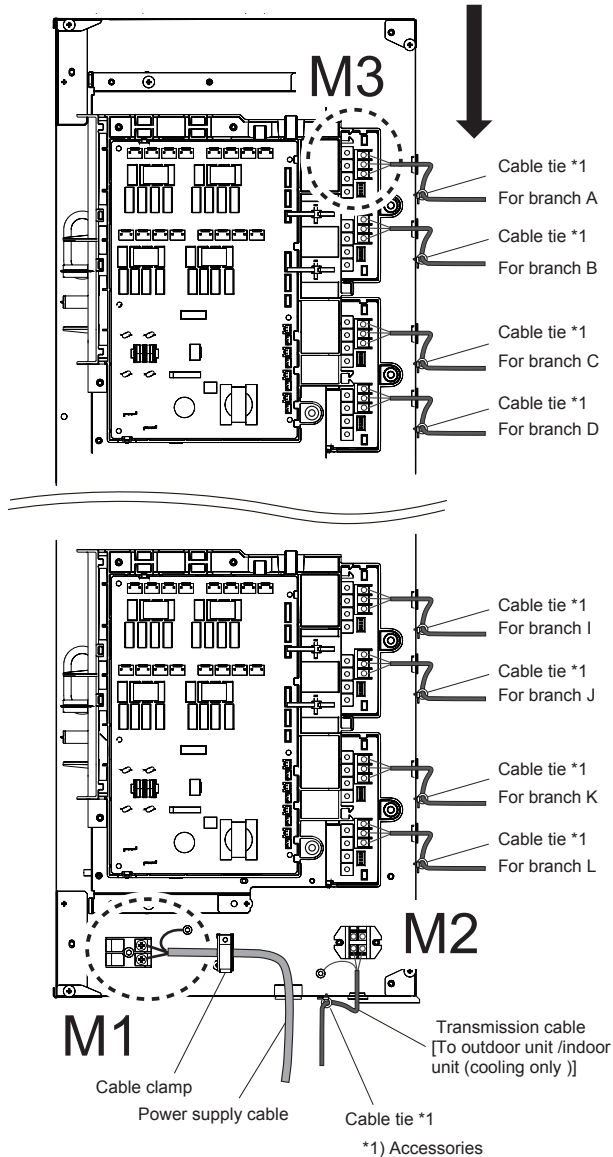

#### Detail M1 : Power supply cable

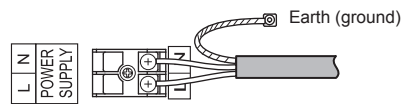

#### Detail M2 : Transmission cable

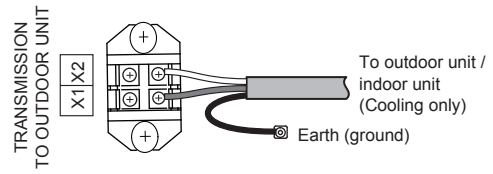

#### Detail M3 : Transmission cable



- (6) Fill the cable holes with putty in order to prevent small animals from entering.
- (7) Install the Control box cover. (4 screws)

## 8. FIELD SETTING

### CAUTION

Use an insulated screwdriver to set the dip switches.



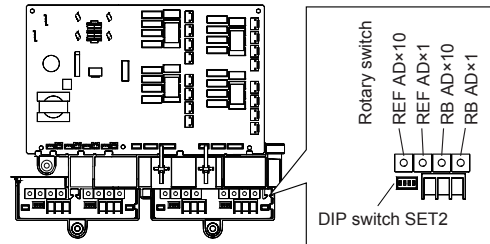

### 8.1. PC board layout

- Before turning ON the power supply, set the switches. (The switch settings will be disabled after the power supply has been turned ON.)



## 8.2. Address setting

- (1) RB unit address  
When connecting multiple RB units to 1 refrigerant system, set the address at RB AD SW.  
Rotary switch (RB AD × 1)...Factory setting "0"  
Rotary switch (RB AD × 10)...Factory setting "0"
- (2) Refrigerant circuit address  
In the case of multiple refrigerant systems, set REF AD SW for each refrigerant system. Set to the same refrigerant circuit address as the outdoor unit.  
Rotary switch (REF AD × 1)...Factory setting "0"  
Rotary switch (REF AD × 10)...Factory setting "0"

Setting	Type of switch	Setting range
RB unit address	<b>Manual address setting</b> Setting example "2"  RB AD × 10  RB AD × 1	0 to 63
	<b>Automatic address setting *1</b> Set this switch to 00 at factory setting.	
Refrigerant circuit address	<b>Manual address setting</b> Setting example "63"  REF AD × 10  REF AD × 1	0 to 99
	<b>Automatic address setting *1</b> Set this switch to 00 at factory setting.	

\*1) For details of automatic address setting, please refer to the outdoor unit installation manual.

- When merging two or four branches and then manually setting the address, set only the rotary switch where the transmission cable is connected.

## 8.3. Function setting

Set the DIP switch SET2, referring to the table.

DIP switch SET2

- (1) Operation mode selecting switch



SET 2		Operation mode	Remarks
1	2		
OFF	OFF	Priority given to the first command	Factory setting
ON	OFF	Priority given to external input of RB unit	—
OFF	ON	Priority given to administrative indoor unit	—
ON	ON	—	Setting forbidden

- (2) Cool/heat selection control time

SET 2		Cool/heat selection control time	Remarks
3	4		
OFF	OFF	6 min	Factory setting
ON	OFF	3 min	—
OFF	ON	—	Setting forbidden
ON	ON	—	Setting forbidden

- If the cool/heat selection control time is short, the sound of passing refrigerant may be loud during the cool/heat selection control process.
- Settings other than those in specified positions are not to be changed.
- To perform a function setting with 2 or 4 branches merged, use the same "DIP switch SET2" setting on all the branches merged.

## 9. EXTERNAL INPUT

- RB unit can be switched cooling priority and heating priority by using RB unit PC board terminal.
- The "external input priority mode" must be set by changing DIP switch SET2-1, 2 on PC board of RB unit.
- A twisted pair cable (22AWG) should be used. Maximum length of cable is 150m.
- Use an external input cable with appropriate external dimension, depending on the number of cables to be installed.
- The wire connection should be separate from the power cable line.

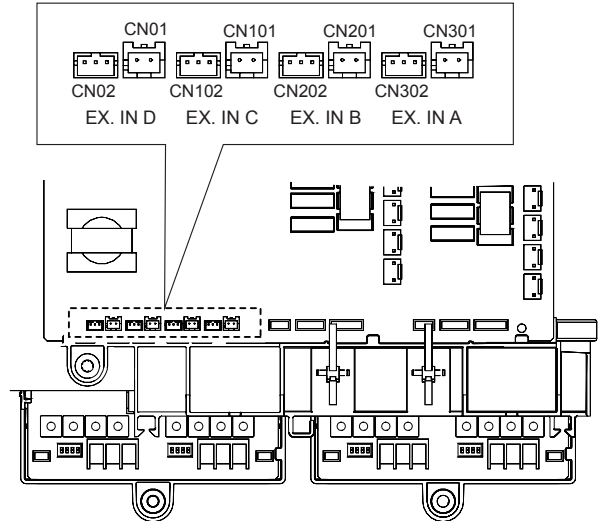

### 9.1. Input select

Use either one of these types of terminal according to the application. (Both types of terminals cannot be used simultaneously.)

#### ■ Dry contact terminal (CNA01, CNA101, CNA201, CNA301)

When a power supply is unnecessary at the input device you want to connect, use the Dry contact terminal (CNA01, CNA101, CNA201, CNA301).

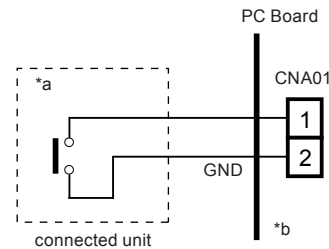

\*a: Select very low current use contacts (usable at DC12V, DC1mA or less).

\*b: The wiring is different from Apply voltage terminals. Be sufficiently careful when wiring.

When connected to Dry contact terminals of multiple RB units with a connected unit, insulate each RB unit with relay, etc. as shown on below example.

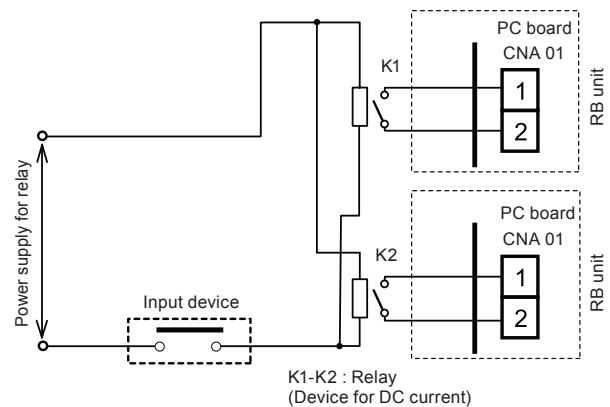

K1-K2 : Relay  
(Device for DC current)

**NOTE :** When connected to multiple RB units directly, it will cause breakdown.

**■ Apply voltage terminal (CNA02, CNA102, CNA202, CNA302)**

When a power supply must be provided at the input device you want to connect, use the Apply voltage terminal (CNA02, CNA102, CNA202, CNA302)

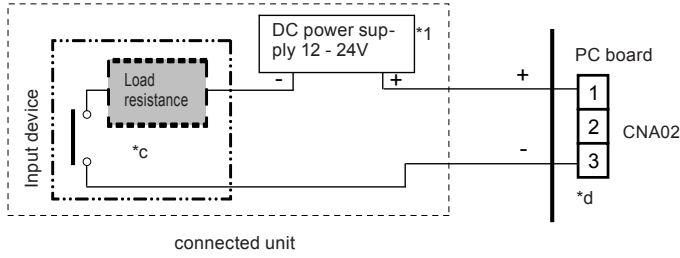

- \*1: Make the power supply DC12 to 24V. Select a power supply capacity with an ample surplus for the connected load. Do not impress a voltage exceeding 24V across pins 1-3.
- \*c: The allowable current is DC 5mA to 10mA. (Recommended: DC5mA) Provide a load resistance such that the current becomes DC10mA or less. Select very low current use contacts (usable at DC12V, DC1mA or less).
- \*d: The polarity is [+] for pin 1 and [-] for pin 3. Connect correctly.

When connected to Apply voltage terminals of multiple RB units with a connected unit, be sure to make a branch outside the RB unit using a pull box, etc. as shown on below example.

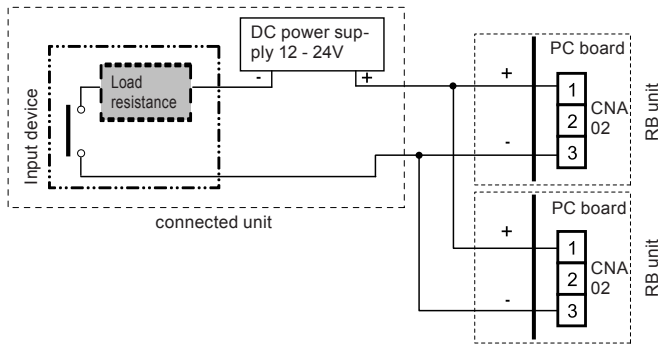

**9.2. Cooling/heating priority function**

**■ "Edge" input only**

Connector	Input signal	Command
CNA01 or CNA02	OFF → ON	Heating priority
	ON → OFF	Cooling priority

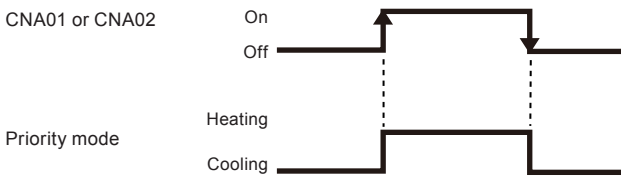

**10. MERGING 2 OR 4 BRANCHES**

- An indoor unit with a capacity exceeding 8.0 kW can be connected by merging 2 or 4 indoor-unit-side outlet branches.
- This chapter should be read only if 2- or 4-branch merging is planned.
- To connect an indoor unit with a capacity exceeding 8.0 kW, use the optionally available separation tube kit.
- For the installing of the separation tube kit, refer to the installation manual for the kit.

**10.1. Connection specifications**

**Typical examples**

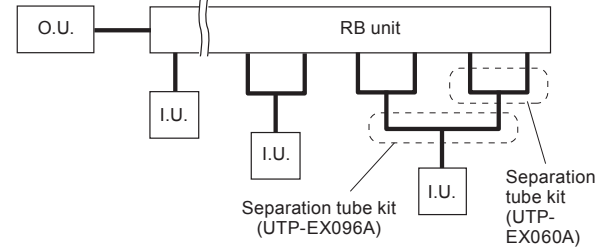

**Connection specifications**

Maximum capacity of connectable indoor units per branch (Q)	2-branch merging	8 < Q ≤ 18 KW
	4-branch merging	18 < Q ≤ 28 KW

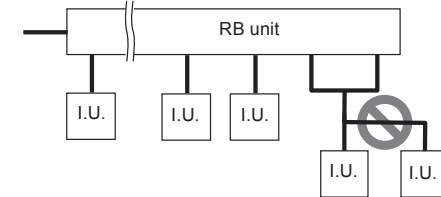

It is not possible to connect multiple indoor units downstream of the point where 2 or 4 branches are merged together.

**10.2. Pipe installation (pipe selection)**

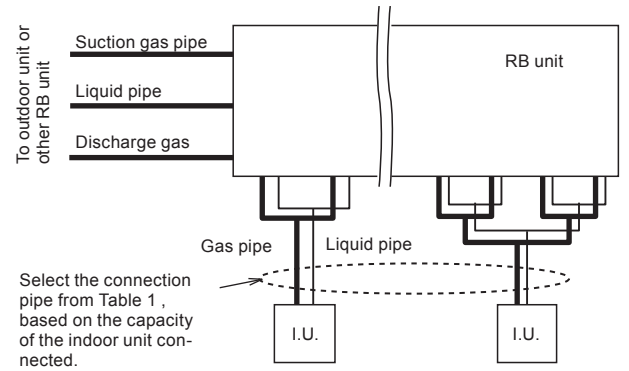

**Table1 ) Indoor unit capacity and connection pipe sizes**

Indoor unit capacity (kW)	Downstream of RB unit Outside diameter [mm(in)]	
	Gas pipe	Liquid pipe
9.0, 10.0	15.88(5/8") +Reducer	9.52(3/8")
11.2, 12.5, 14.0, 18.0	19.05(3/4")	9.52(3/8")
22.4, 25.0, 28.0	22.22(7/8")	12.70(1/2")

## 10.3. Electrical wiring

### 10.3.1 Wiring method

#### ■ 2-branch merging

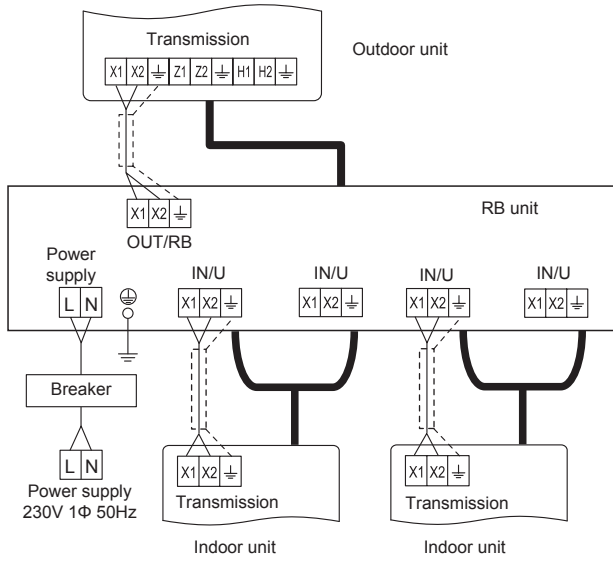

#### ■ 4-branch merging

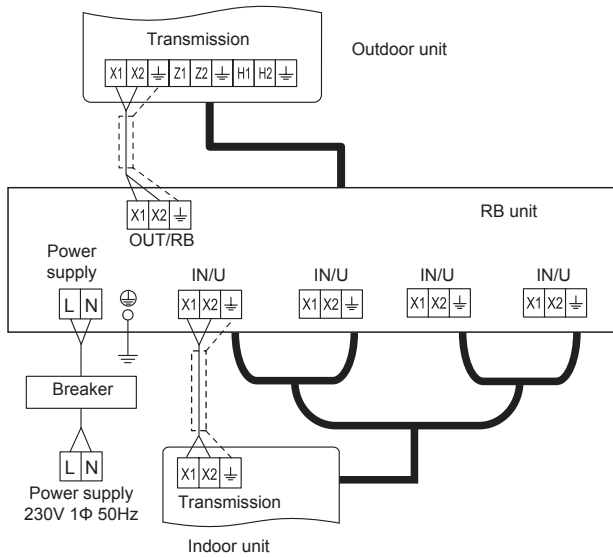

#### ■ When merging 2 branches

- (1) Connect the transmission cable according to the table information.
- (2) Set up the DIP switch S300 according to the table information.

- Only the types of branch combinations that are listed in the table can be merged. (For example, branches B and C cannot be merged with each other).

PC board	Branches that can be merged	DIP Switch S300 "CON-CURRENT OUTPUT"			Cable-connecting terminal block
		1 [4-3]	2 [3-2]	3 [2-1]	
For branches A-D	Branches A and B *1	OFF	OFF	ON	For branch B
	Branches C and D *2	ON	OFF	OFF	For branch D
	Branches A and B *3	ON	OFF	ON	For branch B
	Branches C and D	ON	OFF	ON	For branch D
For branches E-H	Branches E and F *1	OFF	OFF	ON	For branch F
	Branches G and H *2	ON	OFF	OFF	For branch H
	Branches E and F *3	ON	OFF	ON	For branch F
	Branches G and H	ON	OFF	ON	For branch H
For branches I-L	Branches I and J *1	OFF	OFF	ON	For branch J
	Branches K and L *2	ON	OFF	OFF	For branch L
	Branches I and J *3	ON	OFF	ON	For branch J
	Branches K and L	ON	OFF	ON	For branch L

#### \*1) Connection type 1

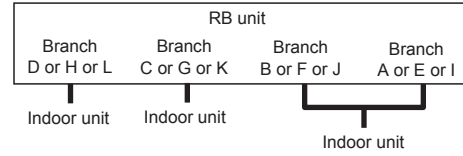

#### \*2) Connection type 2

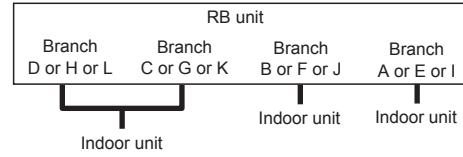

#### \*3) Connection type 3

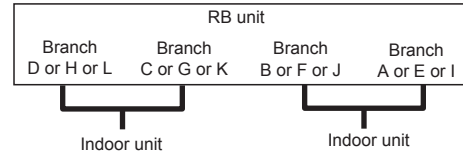

Example) To merge branches A and B or branches C and D

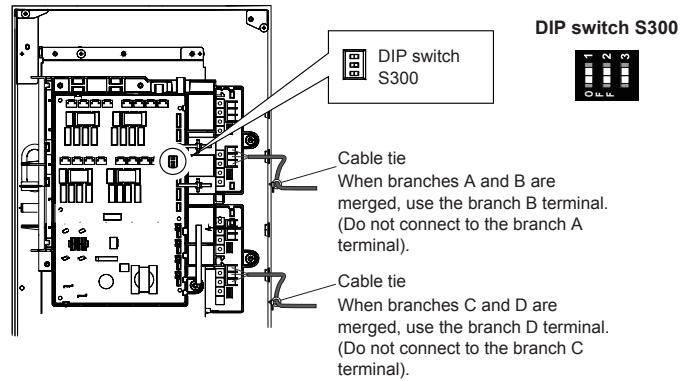

#### ■ When merging 4 branches:

- (1) Connect the transmission cable according to the table information.
- (2) Set up the DIP S300 according to the table information.

- Only the types of branch combinations that are listed in the table can be merged. (For example, branches B, C, D and E cannot be merged together).

PC board	Branches that can be merged	DIP Switch S300 "CON-CURRENT OUTPUT"			Cable-connecting terminal block
		1 [4-3]	2 [3-2]	3 [2-1]	
For branches A to D	Branches A to D	ON	ON	ON	For branch D
For branches E to H	Branches E to H	ON	ON	ON	For branch H
For branches I to L	Branches I to L	ON	ON	ON	For branch L

Example) To merge branches A, B, C and D together

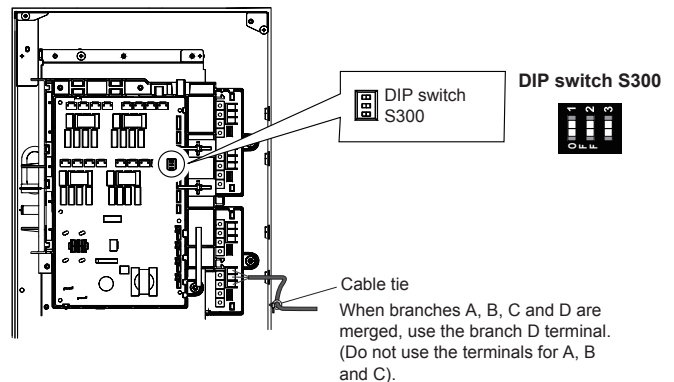

## 10.4. Field setting

### 10.4.1 Address setting

- For the basic setting method, refer to "8.2. Address setting".
- When merging 2 or 4 branches and then manually setting the address, set only the rotary switch where the transmission cable is connected.

#### ■ 2-branches merging

PC board	Branches that can be merged	Rotary switch setting
For branches A-D	Branches A and B *1	Set the branch B switch only
	Branches C and D *2	Set the branch D switch only
	Branches A and B *3 Branches C and D	Set the branch B and D switches only
For branches E-H	Branches E and F *1	Set the branch F switch only
	Branches G and H *2	Set the branch H switch only
	Branches E and F *3 Branches G and H	Set the branch F and H switches only
For branches I-L	Branches I and J *1	Set the branch J switch only
	Branches K and L *2	Set the branch L switch only
	Branches I and J *3 Branches K and L	Set the branch J and L switches only

- \*1) For detailed description about the connection, refer to "Connection type 1" above.  
 \*2) For detailed description about the connection, refer to "Connection type 2" above.  
 \*3) For detailed description about the connection, refer to "Connection type 3" above.

#### ■ 4-branches merging

PC board	Branches that can be merged	Rotary switch setting
For branches A-D	Branches A to D	Use branch D setting only
For branches E-H	Branches E to H	Use branch H setting only
For branches I-L	Branches I to L	Use branch L setting only

### 10.4.2 Function setting

- For the basic setting method, refer to "8.3. Function setting".
- To merge 2 or 4 branches with a function setting, use the same "DIP switch SET2" setting on all the branches being merged.

#### ■ 2-branches merging

PC board	Branches that can be merged	DIP switch SET2 setting
For branches A-D	Branches A and B *1	Use the same switch setting on branches A and B
	Branches C and D *2	Use the same switch setting on branches C and D
	Branches A and B *3 Branches C and D	Use the same switch setting on branches A and B Use the same switch setting on branches C and D
For branches E-H	Branches E and F *1	Use the same switch setting on branches E and F
	Branches G and H *2	Use the same switch setting on branches G and H
	Branches E and F *3 Branches G and H	Use the same switch setting on branches E and F Use the same switch setting on branches G and H
For branches I-L	Branches I and J *1	Use the same switch setting on branches I and J
	Branches K and L *2	Use the same switch setting on branches K and L
	Branches I and J *3 Branches K and L	Use the same switch setting on branches I and J Use the same switch setting on branches K and L

- \*1) For detailed description about the connection, refer to "Connection type 1" above.  
 \*2) For detailed description about the connection, refer to "Connection type 2" above.  
 \*3) For detailed description about the connection, refer to "Connection type 3" above.

## ■ 4-branches merging

PC board	Branches that can be merged	DIP switch SET2 setting
For branches A-D	Branches A to D	Use the same setting value on branches A, B, C and D
For branches E-H	Branches E to H	Use the same setting value on branches E, F, G and H
For branches I-L	Branches I to L	Use the same setting value on branches I, J, K and L

## 11. TEST RUN

### 11.1. Test run using Outdoor unit (PC board)

- Refer to the Installation Manual for the outdoor unit to perform the test run using the outdoor unit.

### 11.2. Test run using Remote Controller

- Refer to the Installation Manual for the remote controller to perform the test run using the remote controller.

## 12. CHECK LIST

Pay special attention to the check items below when installing the RB unit(s). After installation is complete, be sure to check the following check items again.

CHECK ITEMS	If not performed correctly	CHECK BOX
Has the RB unit been installed correctly?	Vibration, noise, RB unit may drop	
Has there been a check for gas leaks (refrigerant pipes)?	No cooling, No heating	
Has heat insulation work been completed?	Water leakage	
Is the voltage of the power source the same as that indicated on the label on the RB unit?	No operation, heat or burn damage	
Is the address setting correctly configured?	No operation	
Is DIP switch S300 correctly set?	No cooling. No heating. Abnormal noise heard.	
Are the wires and pipes all connected completely?	No operation, heat or burn damage	
Is the RB unit earthed (grounded)?	Short circuit	
Is the connection cable the specified thickness?	No operation, heat or burn damage	

## 13. INDICATOR LAMP STATUS

Power indicator lamp (Green)	Error indicator lamp (Red)	Status contents
⊙ (Lit)	—	Lit when the power is turned on.
⊙ (Lit)	⊙ (Lit)	The wiring is incorrect. The "IN/U" terminal of RB unit and outdoor unit transmission terminal are connected with the transmission cable. Correctly connect the wiring. When re-wiring, you must turn off the power.
⊙ (Lit)	● (Flashing)	There is a fault with the communication board or the main board.

- : 0.1s ON / 0.1s OFF