

# Wireless LAN control for air conditioner



[Original instructions]

PART No. 9382758004-05

## SETTING MANUAL

With installation instructions (For authorized service personnel only.)  
Available region: EU Member states

Before using this product, read these instructions thoroughly and keep this manual for future reference.

### Items to Check

\* Prepare the following items before using this product.

Wireless Router	This product uses a wireless router that supports IEEE802.11b/g/n wireless LAN standard. Set the connection to the wireless router with WPS to perform communications by wireless LAN. Refer to the operation manual of the wireless router you wish to use, if it supports IEEE802.11b/g/n or WPS.	
Smartphone or Tablet PC	Supported OS: <ul style="list-style-type: none"><li>• Android OS</li><li>• iOS</li></ul>	Please check the latest supported OS version at Google play or App store.

Android and Google Play are registered trademarks of Google Inc.

App store is a service mark of Apple Inc., registered in the U.S. and other countries.

IOS is a trademark or registered trademark of Cisco in the U.S. and other countries and is used under license.

For information on Wireless LAN (WLAN) control, and the full text of the following EU declaration of conformity, please refer to the following web site.

[www.fujitsu-general.com/global/support/](http://www.fujitsu-general.com/global/support/)

#### SIMPLIFIED EU DECLARATION OF CONFORMITY

The simplified EU declaration of conformity referred to in Article 10(9) shall be provided as follows: Hereby, FUJITSU GENERAL LIMITED declares that the radio equipment type UTY-TFSXZ1 (AP-WC1E), UTY-TFSXW1 (AP-WD1E) is in compliance with Directive 2014/53/EU.

English

Deutsch

Français

Español

Italiano

Ελληνικά

Português

Русский

Türkçe

# Contents

1. SAFETY PRECAUTIONS.....	3	7. SPECIFICATIONS.....	9
2. USAGE PRECAUTIONS.....	4	8. TROUBLESHOOTING.....	10
3. WIRELESS LAN USAGE PRECAUTIONS .....	5	9. SETTING DETAILS.....	12
4. PREPARATIONS FOR USE .....	7	10.WLAN ADAPTER INSTALLATION	
5. INITIALIZATION (Reset).....	8	(For authorized service personnel only) .....	13
6. OPERATING TIPS .....	9		

## Name of Parts

Wireless LAN indicator and button on WLAN adapter

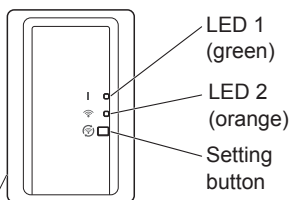

Wireless LAN label

MAC: \*\*\*\*\*  
SSID: AC-UTY-\*\*\*\*\*/  
PIN: \*\*\*\*\*

PIN code is not available for some models.  
Please check the Wireless LAN label.

## Accessories

The following installation accessories are supplied.

Name and Shape	Q'ty
Setting Manual (This manual)	1
Operating Manual (CD-ROM)	1 (*1)
WLAN adapter with cable (with attached wireless LAN label)	1
Tapping screws (M4, 25mm)	2 (*3)
EMI core	1 (*2, *3)

(\*1) For type UTY-TFSXZ1 (AP-WC1E), UTY-TFSXW1 (AP-WD1E) only.

(\*2) For details on use and method of installation, refer to the indoor unit installation manual.



(\*3) These accessories apply to WLAN adapter A only.

## NOTES

- The wireless LAN label attached to the WLAN adapter is necessary for wireless LAN setup.
- Be sure to keep the wireless LAN label by writing the details down or pasting it on the list in "9. SETTING DETAILS".
- The shape of the LED display and Setting button may differ from the illustration above depending on the product.



# 1. SAFETY PRECAUTIONS

- ◆ To prevent personal injury, or property damage, read this section carefully before you use this product, and be sure to comply with the following safety precautions.
- ◆ Incorrect operation due to failure to follow the instructions may cause harm or damage, the seriousness of which is classified as follows:



 <b>WARNING</b>	This mark indicates procedures which, if improperly performed, might lead to the death or serious injury of the user.
 <b>CAUTION</b>	This mark indicates procedures which, if improperly performed, might possibly result in personal harm to the user or damage to property.

 This mark denotes an action that is <b>PROHIBITED</b> .	 This mark denotes an action that is <b>COMPULSORY</b> .
--	---

## **WARNING**

-  • This product contains no user-serviceable parts. Always consult authorized service personnel for repairing, installation, and relocation of this product. Improper installation or handling will cause leakage, electric shock, or fire.
- In the event of a malfunction such as burning smell, immediately stop operation of the air conditioner, and disconnect all the power supply by turning off the electrical breaker or disconnecting the power plug. Then consult authorized service personnel.
-  • Do not repair, disassemble or remodel this product.
- Do not get this product wet or use it in locations with lots of moisture.
- Do not operate with wet hands.
- Do not install this product in locations where the use of wireless equipment is prohibited (e.g. hospitals).
- Do not use this product near persons with a pacemaker or similar devices.
- Do not use this product near automatic control equipment (e.g. automatic doors and fire alarms).

## **CAUTION**

-  • Disconnect all the power supply when you are not using this product for extended periods.
-  • Do not stand on slippery, uneven or unstable surfaces when you operate the unit.
- Do not press the buttons of this product any more strongly than is necessary.

## 2. USAGE PRECAUTIONS

- When you use this product, it will become possible to operate the air conditioner from locations where you cannot see it directly. This means that people in the room may be exposed to the unintended operation of the air conditioner. Check the condition of the room before using this product.
  - **Be sure to check on a regular basis that the power supply to the air conditioner is securely connected, and that dust has not built up in the surrounding area.**  
It may cause heating, or fire.
  - **Be sure to check in advance that there are no malfunctions of the air conditioner.**
  - **Be sure that the airflow from the air conditioner will not cause any adverse effects.**  
Objects may fall down causing personal injury, fire, or damage to property.
  - **If you know that there are people in the vicinity of the air conditioner, inform them in advance that you will be operating and stopping it from a distant location.**  
Sudden operation or stopping of the air conditioner may surprise a person and cause the person to fall down or tumble if the person is on a stand. Furthermore, rapid changes in the outside temperature/room temperature may cause deterioration in a person's physical condition. Do not use this product when there are people in the room who are not able to control the temperature by themselves (For example, infants, children, those with physical disabilities, elderly or sick persons.).
  - **Fully understand the reserved timer settings and other operations before using this product.**  
Unexpected operation or stopping of the air conditioner may cause deterioration in a person's physical condition or an adverse effect on animals or plants.
  - **Frequently check the settings and operating situation of the air conditioner when using this product from a distant location.**  
Rapid changes in the outside temperature/room temperature may cause deterioration in a person's physical condition or an adverse effect on animals or plants.
- If you operate the air conditioner from this product, there will be no flashing of the indicator lamps, nor any reception sounds from the air conditioner.
- If there is bad reception between this product and the wireless router, adjusting the wireless router position or direction of the antenna may improve the reception. It may also be possible to improve reception by moving the wireless router closer to this product or using a wireless LAN repeater.

## 3. WIRELESS LAN USAGE PRECAUTIONS

When you use a wireless LAN, there are precautions that you must follow in relation to radio waves, personal information, and so on. To use this product correctly, be sure to read the following precautions and the operating manual of the wireless LAN equipment you are using. We will assume no responsibility, unless legal liability is recognized, in regards to failures, other defects and damages incurred by use of this product that occur through incorrect use or during use by yourself or a third party.

### 3.1. Radio Wave Usage Precautions



#### CAUTION

Changes or modifications not expressly approved by the party responsible for compliance could void the user's authority to operate the equipment.

This transmitter must not be co-located or operated in conjunction with any other antenna or transmitter.

This equipment complies with FCC/IC radiation exposure limits set forth for an uncontrolled environment and meets the FCC radio frequency (RF) Exposure Guidelines and RSS-102 of the IC radio frequency (RF) Exposure rules. This equipment should be installed and operated keeping the radiator at least 20cm or more away from person's body.

#### NOTES

This device complies with Part 15 of FCC Rules and Industry Canada license-exempt RSS standard(s).

Operation is subject to the following two conditions:

- (1) this device may not cause interference, and
- (2) this device must accept any interference, including interference that may cause undesired operation of this device.

- Do not use this product in the following locations. Using this product in such locations may cause communications becoming unstable or not possible.
  - Near wireless communication equipment that uses the same frequency band (2.4GHz) as this product.
  - Places where there are magnetic fields from equipment such as microwave ovens, or static electricity or radio wave interference occurs.  
(Radio waves may not reach depending on the environment.)

## 3.2. Personal Information (Security-related) Usage Precautions

- There is a possibility of interception if you use wireless LAN equipment due to the use of radio waves regardless of whether you use encryption or not.
- Wireless LAN uses radio waves to exchange information between this product and the wireless router. This means it has the advantage of freely being able to make a LAN connection if within reach of radio waves. On the other hand, if the radio waves are within a certain range, they will reach all locations beyond obstacles (e.g. walls). Therefore, it is possible your communications may be intercepted and read or illegally intruded upon.
- Do not connect to equipment and networks which you are not authorized to use when setting up your wireless connection.
- Initialize the settings of this product when disposing it, or transferring it to a third party.

## 3.3. Others

- Use this product as regular wireless LAN equipment.
  - Do not use this product in hospitals or in/near locations with medical equipment.
  - Do not use this product within aircraft.
  - Do not use this product near electronic equipment that handles high-precision control or weak signals.

Examples of electronic equipment to be careful of:

Hearing aids, pacemakers, fire alarms, automatic doors and other automatic control equipment

- This is not a guarantee of wireless connection and performance with all wireless routers and in all residential environments. Radio waves may not reach or may be interrupted in the following situations.
  - Use in buildings made from concrete, rebars or metal
  - Installation near obstacles
  - Interference with wireless communication equipment using the same frequency
  - Places where there are magnetic fields from equipment such as microwave ovens, or static electricity or radio wave interference occurs
- Install and setup this product only after reading the operating manual of the wireless router.

## 4. PREPARATIONS FOR USE

### 4.1. Application software installation

- 1 *Open “Google Play” or “App Store” depending on the type of your smartphone or tablet PC.*
- 2 *Search for “FGLair”.*
- 3 *Install the application software (mobile app) following the instructions on your screen.*

### 4.2. User registration

- 1 *Open the installed mobile app.*
- 2 *Register the user (with either a smartphone or tablet PC) by following the instructions in the create an account section of the mobile app.*

### 4.3. Air conditioner registration

*Choose from the following modes to connect your air conditioner to your wireless router.*

#### NOTES:

- Before starting this setting, wait for **60 seconds or more** after the power supply is connected to the air conditioner (via breaker or plug). Confirm that the LED 1 is not flashing.
- Check that the smartphone or tablet PC is linked to the wireless router you are connecting the air conditioner. The setting will not work if it is not connected to the same wireless router.
- To control 2 or more air conditioners with the same smartphone or tablet PC, repeat the setup of the chosen mode.

*Register the air conditioner by following the instructions in the online manual on FUJITSU GENRAL web site.*

[www.fujitsu-general.com/global/support/](http://www.fujitsu-general.com/global/support/)

## <How to access the online manual>

- 1 Sign in to the mobile app.
- 2 Open the side menu of the mobile app then tap [HELP].
- 3 Tap [WLAN Support].

When the setup is completed, LED 1 and 2 will both flash 2 times.

## 5. INITIALIZATION (Reset)

Initialize (reset) this product in the following situations:

- Changing the wireless router
- Disposing this product
- Transferring this product to a third party

### ■ Unregister the air conditioner

Unregister the air conditioner by using the mobile app. (Refer to the operation manual of the mobile app for details.)

### ■ Initialization of the WLAN adapter

\*Lighting pattern: ○ Off ● On ☀ Flashing

- 1 Press and hold the Setting button for 10 seconds.
- 2 The initialization will be complete when all LED lamps flashes 3 times simultaneously (on/off at 0.5-second intervals).

**LED 1 will flash. (on/off=2sec/0.5sec)**

**After 60 seconds, the LED lamps will return to the original lighting pattern. (LED1: on, LED 2: on/off=2sec/2sec)**

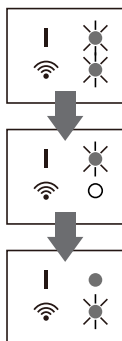

LED1: On  
LED2: 2sec/on  
2sec/off



■ To continue use

If you or a third party wishes to continue use of the product, follow the procedures in "4. PREPARATIONS FOR USE" to reconnect to a different wireless router.

**NOTES:**

Wireless LAN setup is not possible if the previous owner did not unregister or initialize this product. In this case, please contact your authorized service personnel.

## 6. OPERATING TIPS

- For how to operate the mobile app, refer to the operating manual of the mobile app.
  - You can only register 1 Email address and password per WLAN adapter. To add other users (smartphone or tablet PC) to the same WLAN adapter, please use the same Email address and password.
  - The air conditioner settings from the mobile app will not be reflected in the wireless remote controller.
  - It will not be possible to give operation instructions or carry out monitoring from the mobile app while the power supply is disconnected from the air conditioner (via breaker or plug).
  - The room temperature will be displayed in the mobile app during operation. However, the displayed room temperature may not be correct depending on the situation in the room, or the air conditioner operating status. Use this only as a reference.
  - If the mobile app and remote controller settings differ, the latest operation performed will take priority.
- \* If timer settings are done from the mobile app and from the wireless or wired remote controller, both timer settings will be active.

## 7. SPECIFICATIONS

Wireless LAN-compatible standard	IEEE802.11b/g/n
Frequency bands	2.4GHz (in the U.S. or Canada: 1ch ~ 11ch) (in the other regions: 1ch ~ 13ch)

Maximum radio-frequency power	80mW
Wireless LAN security	Open WEP WPA (PSK) WPA2_Personal (PSK) WPS for same-LAN Registration
Operating temperature	0 - 46 °C (32 - 114 °F)

**NOTES:**

This product can be used only in the available region. (Refer to the cover.)

## 8. TROUBLESHOOTING

Check the following items before requesting repairs to this product.

Parts/Elements	Situation	Solutions
Mobile app (Download and account registration)	I don't know how to download the mobile app.	Refer to "4.1. Application software installation".
	I am not able to use the mobile app	Check that the version of the OS on your mobile device is supported. Refer to "Items to Check".
	I have not received the e-mail when registering my account	Set the domain permissions so that it is not rejected as spam.
	The method of registering additional users is unclear	You can only register 1 Email address and password per WLAN adapter. Use the same Email address and password for other users to operate through the same WLAN adapter.
	The method of registering additional air conditioners is unclear	To register additional air conditioners, repeat the setup of the chosen mode in "4.3. Air conditioner registration" for each air conditioner.

Parts/Elements	Situation	Solutions
Wireless LAN setup and initial settings	Wireless LAN setup is not possible	Check that your wireless router supports "WPS function". (Button mode)
		Check if there was any previous owner using this wireless LAN control. If there was a previous owner, please contact authorized service personnel.
	Wireless LAN setup is not possible (The connection settings of the WLAN adapter and router are not complete)	Check that your wireless router supports "IEEE802.11b/g/n". (Check with the operating manual of the wireless router.)
		Check that the WLAN adapter of the indoor unit is on. (Check that the LED of your WLAN adapter is lit or flashing.) * If the LED is set to turn off in the mobile app, it will not light up or flash.
Operations from the mobile app	I am not able to operate this product from the mobile app	Check that the power to the indoor unit is on.
		Check that the power to the wireless router is on.
		Check that your smartphone is not in flight mode.
		Check that you are not in a place where it is difficult to make a connection with radio waves.

## ■ State of the Wireless LAN indicators

\*Lighting pattern: ○ Off ● On  Flashing

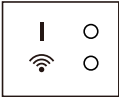
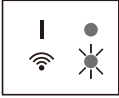
State of the Lamps	Causes and Solutions
All the lamps are off  	The power to the WLAN adapter is not on. → Check that the power to the air conditioner is on and that the air conditioner breaker is not tripped.
	The LED lamps are turned off by setting from the mobile app. → Refer to the operating manual of the mobile app.
LED 2 is off or flashing fast (Repeating 0.5 seconds on / 0.5 seconds off)  	The power to the wireless router is not on. → Check that the power to the wireless router is on.
	There is a possibility that the WLAN adapter is not properly connected to the wireless router. → Disconnect the power supply to the air conditioner (via breaker or plug), and then re-connect.

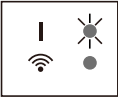
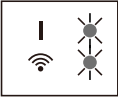
State of the Lamps		Causes and Solutions
LED 1 is flashing fast (Repeating 0.5 seconds on / 0.5 seconds off)		It is not possible to communicate with the air conditioner. → If the flashing continues for more than a few minutes, there may be a wiring error in the air conditioner. Please contact authorized service personnel.
All the lamps are flashing fast (Repeating 0.5 seconds on / 0.5 seconds off)		There is a problem with the WLAN adapter. → Disconnect the power supply to the air conditioner (via breaker or plug), and then re-connect. Setup the wireless LAN again according to the procedures in "4. PREPARATIONS FOR USE".

If the problem persists even after you perform these checks or diagnostics, consult authorized service personnel.

## 9. SETTING DETAILS

Record the setting details in the following table.

### ■ Setting information

SSID	
MAC address (MAC)	
PIN	
System commissioning date	

### ■ Installer contact details

Name	
Telephone no.	

# 10. WLAN ADAPTER INSTALLATION

## (For authorized service personnel only)

### 10.1. Before installing the WLAN adapter

#### WARNING

- For the air conditioner to operate satisfactorily, install it as outlined in this installation manual.
- Installation work must be performed in accordance with national wiring standards by authorized personnel only.

#### CAUTION

- Install the WLAN adapter near the wireless router. (The connection will become unstable if it is placed further away, which will make using the system more difficult.)
- Certain types of wall materials may shut out wireless communications.
- Do not touch the heat exchanger.
- During installation or removal, do not have the wire caught by any parts nor pull it hard. It may result in malfunction of the air conditioner.

#### **[Additional cautions for WLAN adapter A (Refer to “Accessories”).]**

- Do not bundle the WLAN adapter wiring with the connection cable running between the indoor and outdoor units, or the power supply cable.
- Install the WLAN adapter between the indoor unit and wireless router.
- Please do not install the WLAN adapter in the following places. Otherwise, radio communication may be interfered.
  - Places exposed to direct sunlight
  - Places subject to extremely high and low temperatures, such as near the outlet port of the air conditioner main body
  - Near the air conditioner air inlet or outlet
  - Places with high humidity
  - Places near moving parts of the air conditioner main body
  - Places near the bottom of the air conditioner main body
  - Inside or on the side of the air conditioner main body
  - Near microwave ovens
  - Within 1 m (40 in) of a TV or radio
  - Places in the reach of children
  - Near automatic control devices such as automatic door sensors or fire detectors
  - Places with oil, vapour or flammable gases
  - Near medical equipment, pacemakers, defibrillators or other devices
  - Places where the WLAN adapter could get wet, such as in the bathroom
  - Places where the WLAN adapter is difficult to access for maintenance
- Please install the WLAN adapter in a place where the switches and buttons can be operated and where the LED display can be confirmed. (In the areas shown below.)

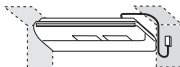
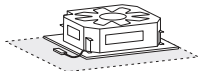
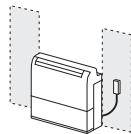
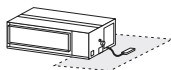

## 10.1.1 System diagram

One WLAN adapter can be connected to each indoor unit.

### Single connection

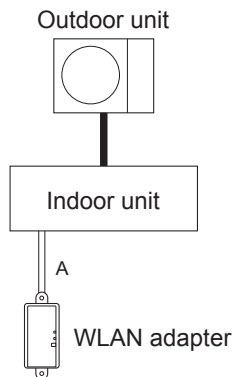

### Multiple connection

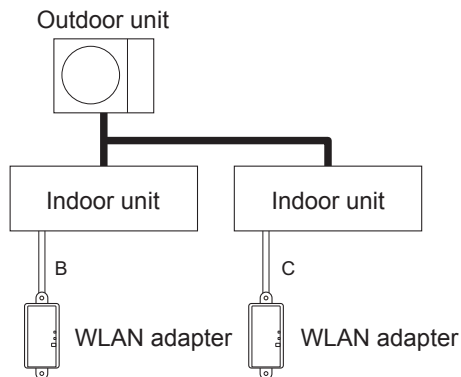

A, B, and C: Adapter cable attached to this product.

### Prohibited uses:

(1) Group connection of indoor units with wired remote controller

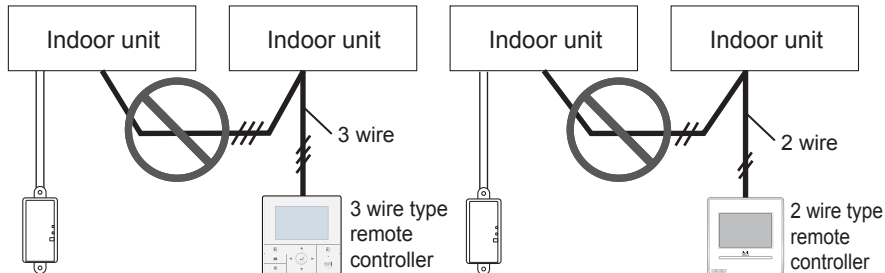

(2) Group connection of indoor units

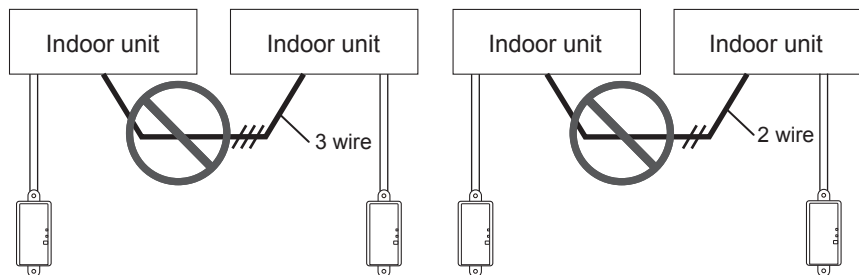

## Prohibited uses(continued):

(3) Group connection of indoor units with WLAN adapter cable.

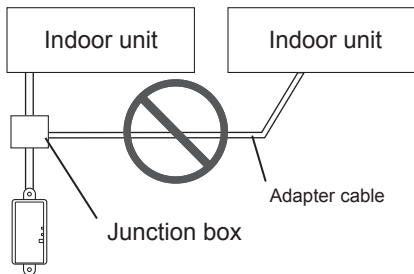

(4) Extended wiring  
Extending the cable is prohibited.

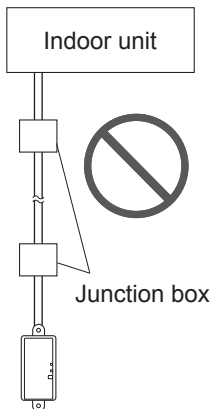

## 10.2. Installation work

The installation work mentioned is for WLAN adapter A (Refer to “Accessories”). For WLAN adapter B, please refer to the installation manual of the indoor unit.

### WARNING

- Disconnect the power supply or turn off the breaker before starting work. Failure to disconnect the power supply may lead to electric shock or fire.
- Do not turn on the power until all installation work is complete.
- Use the accessories or specified connection cables.  
Do not modify connection cables other than those specified, do not use extension cords, and do not use independent branch wiring. The allowable current will be exceeded and cause electric shock or fire.
- When installing this unit, make sure that there are no children nearby.  
Otherwise, injury or electric shock could result.

### CAUTION

- Discharge static electricity on your body before starting work. If static electricity is not discharged, there is a risk that the board parts may be damaged.
- When performing wiring work, be careful not to damage the cable or injure yourself. Also, connect the connectors securely. Loose connectors will cause trouble, heating, fire, or electric shock.
- Perform wiring so that water does not enter this unit along the external wiring. Always install a trap to the wiring or take other countermeasures. Otherwise it will cause trouble or electric shock or fire.
- Do not touch the circuit board and circuit board parts directly with your hands. Otherwise, injury or electric shock could result.

## 10.2.1 Wire connection

For the connection details, refer to the installation manual of the indoor unit.  
Attach the connector directly to the printed circuit board.

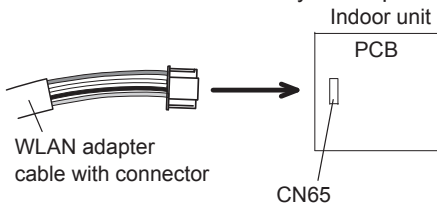

\*Notes: Options connecting to CN65 cannot be used at the same time.

## 10.2.2 Installing the WLAN adapter

Install the WLAN adapter in the direction as shown in the figure.

If the WLAN adapter is installed in a wrong direction, water may get into the adapter through the wire, causing failure.

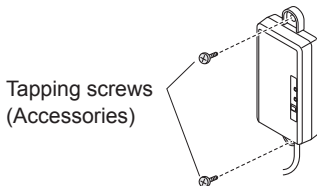

**GOOD**

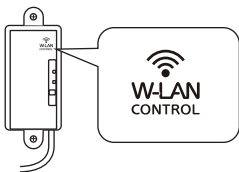

**PROHIBITED**

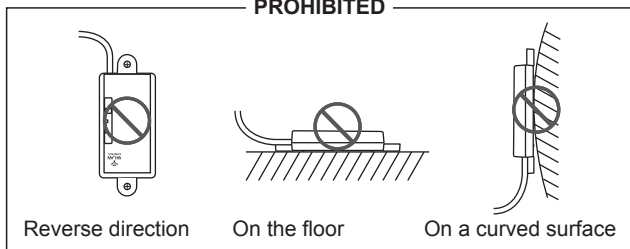

Do not lay the WLAN adapter cable on the floor. You may trip on the cables.

**GOOD**

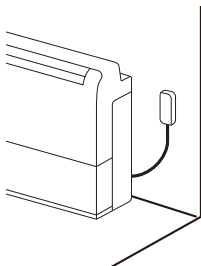

**PROHIBITED**

