

UTY-VSGXZ1

INSTALLATION MANUAL

SIGNAL AMPLIFIER

For authorized service personnel only.

English

INSTALLATIONSANLEITUNG

SIGNALVERSTÄRKER

Nur für autorisiertes Fachpersonal.

Deutsch

MANUEL D'INSTALLATION

AMPLIFICATEUR DE SIGNAL

Pour le personnel agréé uniquement.

Français

MANUAL DE INSTALACIÓN

AMPLIFICADOR DE SEÑALES

Únicamente para personal de servicio autorizado.

Español

MANUALE DI INSTALLAZIONE

AMPLIFICATORE DI SEGNALE

A uso esclusivo del personale tecnico autorizzato.

Italiano

ΕΓΧΕΙΡΙΔΙΟ ΕΓΚΑΤΑΣΤΑΣΗΣ

ΕΝΙΣΧΥΤΗΣ ΣΗΜΑΤΟΣ

Μόνο για εξουσιοδοτημένο τεχνικό προσωπικό.

Ελληνικά

MANUAL DE INSTALAÇÃO

AMPLIFICADOR DE SINAL

Apenas para técnicos autorizados.

Português

РУКОВОДСТВО ПО УСТАНОВКЕ

УСИЛИТЕЛЬ СИГНАЛА

Только для авторизованного обслуживающего персонала.

Русский

MONTAJ KILAVUZU

SİNYAL AMPLİFİKATÖRÜ

Yalnızca yetkili servis personeli için.

Türkçe

安装说明书

信号放大器

仅针对授权的专业维修人员。

中文



PART No. 9377898043-03

FUJITSU GENERAL LIMITED

INSTALLATION MANUAL

PART No. 9377898043-03
SIGNAL AMPLIFIER

CONTENTS

1. SAFETY PRECAUTIONS	1
2. MAIN UNIT AND ACCESSORIES	1
3. ELECTRICAL REQUIREMENT	1
4. SELECTING AN INSTALLATION LOCATION	2
4. 1. Dimensions	2
5. WIRING	2
5. 1. Check point	2
6. INSTALLING THE SIGNAL AMPLIFIER	3
6. 1. Connecting the power supply cable	3
6. 2. Connecting the transmission cables	3
6. 3. Installing the terminal resistor	4
6. 4. Filter mode setting	4
7. TURNING ON POWER	4
8. ADDRESS SETTING	4
9. ERROR CODE	5

1. SAFETY PRECAUTIONS







- The "SAFETY PRECAUTIONS" indicated in this manual contain important information pertaining to your safety. Be sure to observe them.
- Request the user to keep this manual on hand for future use, such as for relocating or repairing the unit.

	WARNING	This mark indicates procedures which, if improperly performed, might lead to the death or serious injury of the user.
Perform electrical work by an authorized service personnel in accordance with this manual and the electrical wiring regulations or implementation regulations of the country. Also do not install this unit by yourself. Improper electric work will cause electric shock or a fire.		
Perform installation work in accordance with this manual. Request an authorized service personnel to perform installation work. Do not install this unit by yourself. Improper installation will cause injury, electric shock, fire, etc.		
In the event of a malfunction (burning smell, etc.), immediately stop operation, turn off the electrical breaker, and consult authorized service personnel.		
Install a leakage circuit breaker to power supply cable in accordance with the related laws and regulations and electric company standards.		
Use a power source exclusively for this unit. Never share the power source with other electrical equipment. Doing so will cause fire and electric shock.		
Do not install the unit in the following areas:		
<ul style="list-style-type: none"> • Do not install the unit near a source of heat, steam, or flammable gas. • Area filled with mineral oil or containing a large amount of splashed oil or steam, such as a kitchen. It will deteriorate plastic parts, causing the parts to fail or the unit to leak water. • Area that generates substances that adversely affect the equipment, such as sulfuric gas, chlorine gas, acid, or alkali. It will cause the copper pipes and brazed joints to corrode, which can cause refrigerant leakage. • Area containing equipment that generates electromagnetic interference. It will cause the control system to malfunction, preventing the unit from operating normally. • Area that can cause combustible gas to leak, contains suspended carbon fibers or flammable dust, or volatile inflammables such as paint thinner or gasoline. If gas leaks and settles around the unit, it can cause a fire. • Do not use the unit for special purposes, such as storing food, raising animals, growing plants, or preserving precision devices or art objects. It can degrade the quality of the preserved or stored objects. • Install the unit in a well-ventilated place avoiding rains and direct sunlight. 		
Do not operate this unit when your hands are wet. Touching the unit with wet hands will cause an electric shock.		
If children may approach the unit, take preventive measures so that they cannot reach the unit.		

	CAUTION	This mark indicates procedures which, if improperly performed, might possibly result in personal harm to the user or damage to property.
Pay abundant care when transporting this unit because it is a precision device. Improper transportation will cause trouble.		
Do not touch the switches with sharp objects. Doing so will cause injury, trouble, or electric shock.		
Do not expose this unit directly to water. Doing so will cause trouble, electric shock, or heating.		
Do not set vessels containing a liquid on this unit. Doing so will cause heating, fire, or electric shock.		
Dispose of the packing materials safely. Tear and dispose of the plastic packing bags so that children cannot play with them. There is the danger of suffocation if children play with the original plastic bags.		
Do not insert articles into the slit parts of this unit. Doing so will cause trouble, heating, or electric shock.		

2. MAIN UNIT AND ACCESSORIES

The following installation parts are supplied. Use them as required.

Name and Shape	Q'ty	Application
Signal amplifier 	1	Main unit
Installation manual 	1	This manual
Cable tie 	3	For mounting the power supply cable and transmission cable.
Screw (M4 x 20 mm) 	4	For mounting the signal amplifier.
Terminal resistor 	1	It is used when there is no terminal resistor in a network segment.
Dust proof bushing 	1	For connecting the power supply cable. (Except in U.S.A. and Canada)
Connecting wire 	1	For setting the filter mode

3. ELECTRICAL REQUIREMENT

Use	Size		Wire type	Remarks
Power supply cable	Maximum	1.25 mm ² (16AWG)	Type 60245 IEC 57 or equivalent	1Ø AC208–240 V 50/60Hz, 2 Cable + earth (ground) [Always earth (ground) the unit]
	Minimum	0.5 mm ² (20AWG)		
Transmission cable	0.33 mm ² (22AWG)		22AWG LEV-EL4 (NEMA) nonpolar 2 core, twisted pair solid core Shielded	LONWORKS® compatible cable
Fuse capacity	3 A			

* **LONWORKS®** is registered trademark of Echelon Corporation in the United States and other countries.

Heat recovery system (Indoor unit is installed 321 to 400 units)

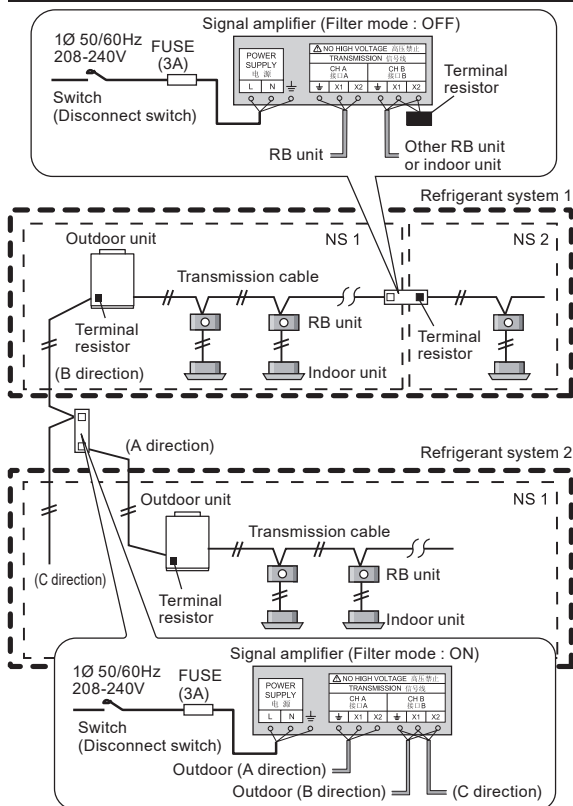

Note: When switching the Filter mode to ON, refer to 6.4 Filter mode setting.

6. INSTALLING THE SIGNAL AMPLIFIER

⚠ WARNING

Always use the accessories and specified installation work parts. Check the state of the installation parts. Not using the specified parts will cause units to fall off, water leakage, electric shock, fire, etc.

Install at a place that can withstand the weight of the unit and install positively so that the unit will not topple or fall.

When installing this unit, make sure that there are no children nearby. Otherwise, injury or electric shock could result.

Install a circuit breaker. Otherwise, electric shock or fire could result.

⚠ CAUTION

Before opening the cover of this unit, completely discharge static electricity charged on your body. Otherwise, failure or malfunction could result.

Do not touch the PC board and PC board parts directly with your hands. Otherwise, injury or electric shock could result.

Tightening the mounting screws too tight will damage the body of this unit.

Be careful so that the cover does not fall after the cover screws are removed. Otherwise, injury could result.

Tightening torque for installing cables to terminal block

0.8 to 1.2 N · m (7.1 to 10.6 lbf · in)

6.1. Connecting the power supply cable

for U.S.A. and Canada

- Remove the 4 screws (M4 × 6 mm), and then remove the cover.
- Install the conduit.
- Fix the conduit with lock nut.
- Pass the power supply cable through the conduit.
- Connect the power supply cable to their respective terminal block and the earth (ground).
- Securely tighten the cable tie and then confirm that the cable will not come out.

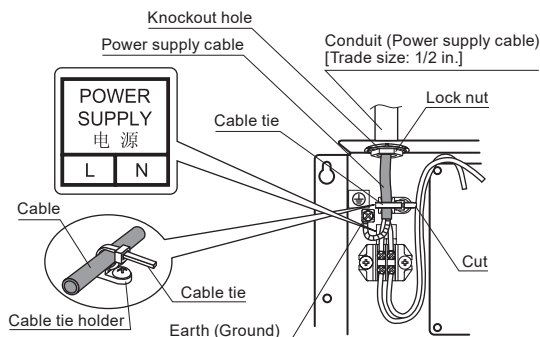

for Others

- Remove the 4 screws (M4 × 6 mm), and then remove the cover.
- Open the knockout hole, and then install dust proof bushing. If small animals such as insects and dust enter this unit, a short circuit may be caused.
- Make a hole in the center of the dust proof bushing with the Phillips head screwdriver.
- Pass the power supply cable through the hole of dust proof bushing and pull it into the signal amplifier.
- Connect the power supply cable to their respective terminal block and the earth (ground).
- Securely tighten the cable tie and then confirm that the cable will not come out.

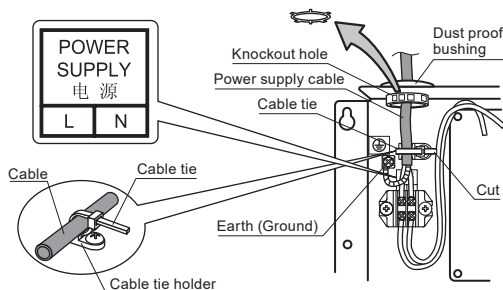

6.2. Connecting the transmission cables

- Turn the power off.
- Make a hole in the center of the dust proof bushing with the Phillips head screwdriver.
- Pass the transmission cables through the hole of dust proof bushing and pull it into the signal amplifier.
- Connect the transmission cables to their respective terminal block properly. (Install the terminal resistor if needed.)
- Securely tighten the cable tie and then confirm that the cable will not come out.
- Once the wiring of the cables has been completed, mount the cover to the signal amplifier. Use the screws (M4 × 6 mm) to mount the cover.
- Use the 4 screws (M4 × 20 mm) provided to mount the signal amplifier to the behind ceiling, wall, floor or other suitable location.

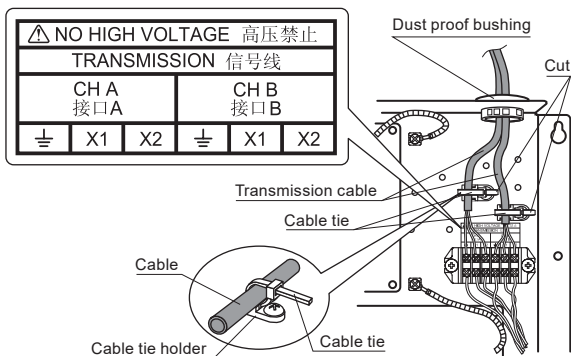

6.3. Installing the terminal resistor

CAUTION

Be sure to install the terminal resistors as specified. Install a terminal resistor for each network segment.

If a terminal resistor is installed to more than 1 device in a single network segment, the entire communication system may be damaged.

If a terminal resistor is not installed to any device in a single network segment, communication errors may occur.

- Be sure to install 1 terminal resistor in a network segment. The terminal resistor can be installed to an outdoor unit or to a signal amplifier.
- When a terminal resistor is installed to an outdoor unit, refer to the installation manual supplied with the outdoor unit.
- When installing multiple terminal resistors, observe the following conditions:
 - (1) Divide the VRF system into multiple network segments.
 - (2) Install a terminal resistor in each network segment. (Conditions for 1 segment: total number of outdoor units, indoor units, signal amplifier, touch panel controller and network convertor, etc. must be 64 units or less, and the total length of the transmission cables must be 500 m (1640 ft.) or less.)
- One terminal resistor is required for each network segment.
- When installing a terminal resistor, connect it between X1 and X2 of CHA or CHB on the transmission terminal block.
- The terminal resistors have no polarity.

6.4. Filter mode setting

- Set the Filter mode to suppress an increase of the amount of communication information in the heat recovery system.

Outdoor unit type	Indoor unit number	Connecting wire *1	Filter mode
Heat pump system	2 to 400 units	○	OFF
Heat recovery system	2 to 320 units	○	OFF
	321 to 400 units	● / ○	ON / OFF

*1. For the "Necessary" or "Not Necessary" details of Filter mode setting, refer to the Design & Technical Manual for the heat recovery system.

- : Necessary
- : Not necessary

- Filter mode is turned on by inserting the accessory connecting wire at the CN4 connector on the PC board.
- When the Filter mode setting is changed, turn the power off once. Otherwise, the setting will not be recognized.

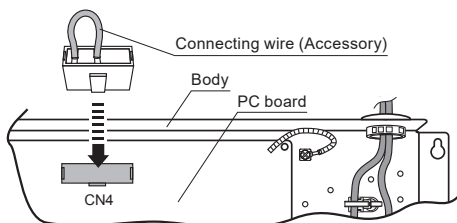

7. TURNING ON POWER

CAUTION

Check that the power supply voltage is within the specified range. If the power supply voltage outside the specification is input, it will cause trouble.

Recheck the wiring. Incorrect wiring will cause trouble.

- (1) Check the signal amplifier wiring.
- (2) Check the wiring and switch settings for the VRF system and turn on the power for the VRF system. For the wiring and switch setting method, refer to the installation manual of each unit.
- (3) Turn on the power for the signal amplifier.
 - The signal amplifier is initialized for a period of approximately 5 seconds after the power is turned on. **88** is displayed on D19-indicator during this period.
 - After initial setting completely, the operation mode will be started. **88** is displayed on D19-indicator.

- * Signal amplifier does not operate during initialization.
- * If an error occurs, the D9 or D14 LED lights or flashes, or the error code is displayed on the right digit of the D19-indicator.

8. ADDRESS SETTING

When connecting multiple signal amplifiers, perform the following address setting.

PC BOARD LAYOUT

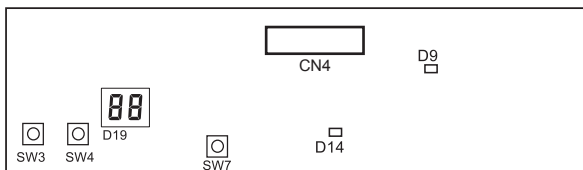

AUTOMATIC ADDRESS SETTING

1. Turn on the power for the signal amplifier.
2. Confirm that D19-indicator indicates ADDRESS A1 (*1). (Factory setting: A1)
3. After checking, press the RESET button.
4. The address is set from an outdoor unit by the automatic operation. (Refer to outdoor unit installation manual.)

When the automatic address setting and manual address setting are mixed, the unit set to A2-A8 or A25-A56 in the manual address setting is not intended for the automatic address setting.

*1. When the automatic address setting is selected, the indicators change is A9-A16 or A57-A88.

MANUAL ADDRESS SETTING

1. Turn on the power for the signal amplifier.



2. While holding down SW4 (the set button), press and release SW7 (the reset button) to enter the address setting mode. The address setting mode is activated only if the set button is held down when SW7 released.

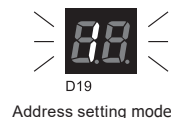

3. Press SW4 (the set button) to display the current address. The address is set to A1 at the factory.

Example 1) When A1 is set



Example 2) When A12 is set

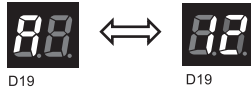

4. Press SW3 (the mode button) to select the address. The displayed address changes as follows each SW3 button is pressed. When the manual setting is selected, the indicators change as follows:

SIGNAL AMPLIFIER (Filter mode : OFF)

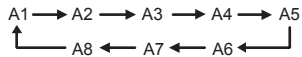

SIGNAL AMPLIFIER (Filter mode : ON)

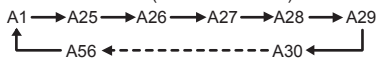

Ex.) Address A5 is selected.

- Press the SW3 when A9-A16 or A57-A88 is displayed, then A1 will be displayed.
- If connecting multiple signal amplifiers, be sure to select a different address for each amplifier. If the same address is used for different signal amplifiers, normal communication cannot be done.

5. Press SW4 (the set button) to set the selected address.



Ex.) Address A5 is set.

6. Turn the power off and on or press SW7 (the reset button) to exit the address setting mode and return to the normal mode.

If an address setting error occurs ("26" is displayed on the D19-indicator), the address will not be set. Perform address setting again.



D19

Normal mode



D19

Address setting error

9. ERROR CODE

Error code	Contents
	Address setting error
	Main PCB error
D9 LED lit or flashing D9 D9	Communication error B
D14 LED lit or flashing D14 D14	Communication error A