

- Circular
- Flame retardant PVC
- Standard



## Adjustable constant air volume dampers type KVR-R

Constant volume control dampers made of fire retardant plastics. The range covers an air flow range between 15 up to 700 m<sup>3</sup>/h within a pressure range from 50 up to 250 Pa. Air flow can easily be adjusted within the airflow range of each damper.

### Application

- To obtain constant air volumes in ventilation and air conditioning systems within a pressure range between 50 and 250Pa
- For air supply or exhaust duct systems
- Maximum working temperature 60°C

### Colour

- Black

### Composition

- Valve and piston made out of fire retardant plastics M1
- Body in fire retardant plastics M1
- Stainless steel calibrated spring
- Rubber air-tight sealing

### Mounting

- For mounting inside round ducts
- Horizontal as well as vertical mounting applicable
- For horizontal mounting, the BAS marking has to be at the bottom
- To be installed in accordance with the correct air flow direction
- To be installed in the air intake at a minimum distance of three times the diameter of the duct starting from the air intake grilles and at the same distance from places with a high degree of turbulence in the duct, such as branches, bends,....
- To be installed in the air outtake at a minimum distance of one time the diameter of the duct starting from the extraction grilles and at the same distance from places with a high degree of turbulence in the duct, such as branches, bends,....
- The volume control damper has to be easily accessible for maintenance

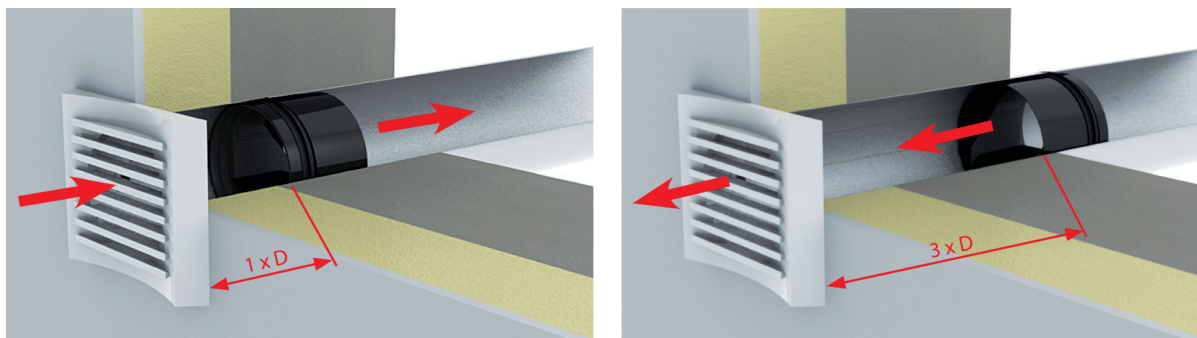
**Accessories**

- Screw driver Torx T10 for unscrewing the screw for adjusting the air flow rate of the regulator.

**Other available products**

- **KVR-R-HP**: High pressure constant volume dampers with a pressure range between 150 and 600Pa

### Pressure loss

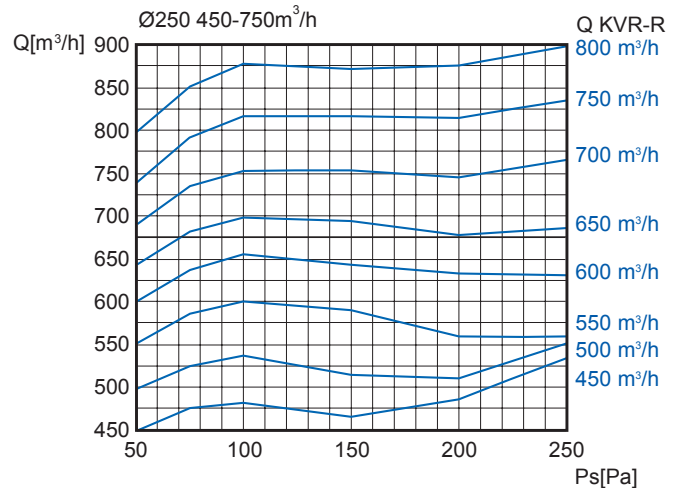
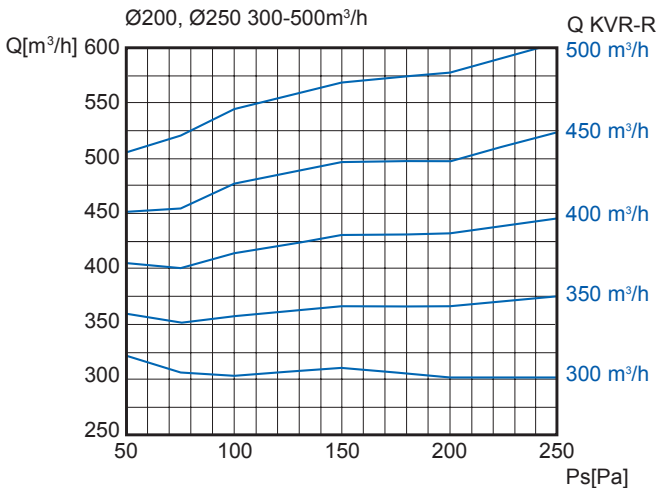
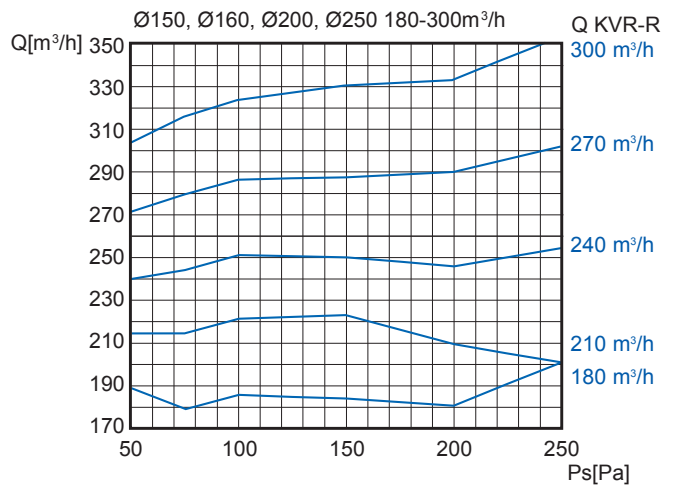
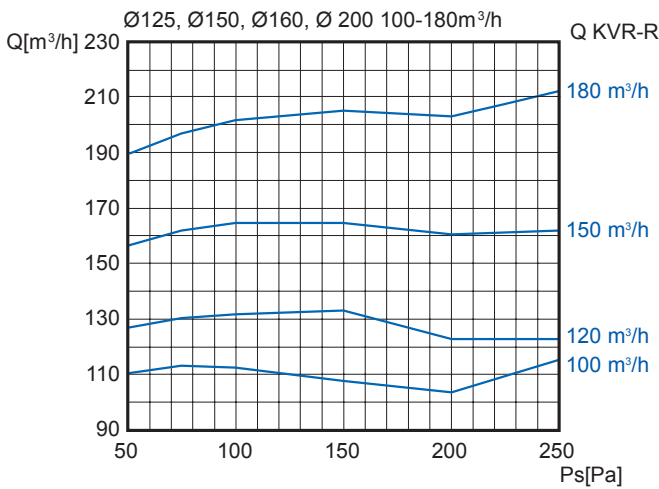
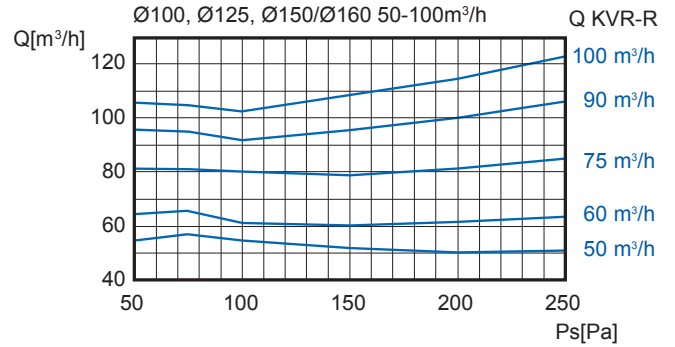
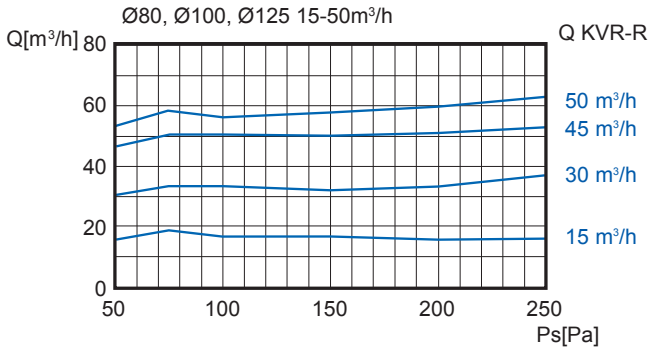

### Symbols and specifications

- Q [m³/h] = Air flow rate in m³/h
- Q KVR-R = Set flow rate in the volume control damper
- Ps [Pa] = Static pressure loss in the volume control damper in Pa
- The graphs characterize the variations in the air flow in air supply and extraction with respect to the pressure differential in Pascal at a pressure set between 50 and 250Pa. The flow rates shown are average values and may vary as follows:
  - For Ø80: +/- 3 m³/h
  - For Ø100 and Ø125: +/- 3 m³/h for air volume <= 50 m³/h, +/-5% for air volume >50 m³/h
  - For Ø150, Ø160, Ø200 and Ø250: +/- 5%

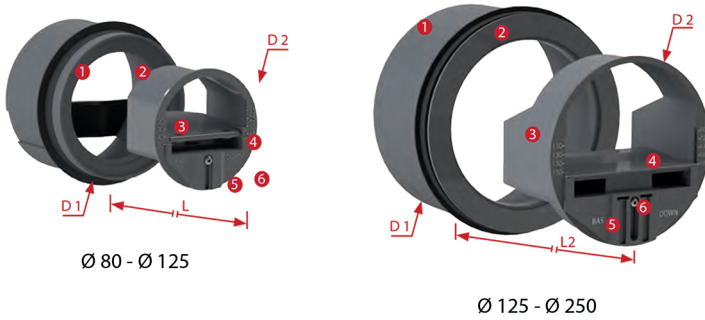

### Construction

- 1. Collar with sealing
- 2. Intermediate piece according to the air flow rate
- 3. Casing
- 4. Regulating element
- 5. Air flow rate regulating module
- 6. Blocking screw for regulating module

	Dimensions		
	D1 [mm]	D2 [mm]	L [mm]
Ø 80	76	76	55
Ø 100	96	93	70
Ø 125	120	117	86
Ø 150	146	148	91
Ø 160	146	148	91
Ø 200	190	195	91
Ø 250	245	236	127

### Adjustment



Q [m³/h]	Sound data			
	50Pa	100Pa	150Pa	200Pa
15	25	29	32	35
25	26	30	33	36
30	26	31	35	38
45	27	33	36	39
50	29	35	37	41
60	32	37	39	42
75	32	37	40	42
90	32	38	41	44
100	33	39	42	45
120	30	34	39	42
150	33	37	41	45
180	34	40	44	47
210	34	40	42	44
240	35	41	44	47
270	37	43	45	49
300	33	37	42	45
350	35	40	44	47
400	37	42	45	50
450	38	44	46	51
500	39	46	48	53

### Symbols and specifications

- Q [m³/h] = Air flow rate in m³/h
- Ps [Pa] = Static pressure loss in the volume control damper in Pa
- Lw [dB(A)] = Sound power in dB(A)